

Derwent
Top 100
Global
Innovator
2020

Metasol *Meta Solution*

Adjustable Low voltage circuit breakers



LS ELECTRIC



***Upgraded for the global
best worth!***

Metasol

Adjustable Molded case circuit breaker

Marking and configuration	12
External configuration	13
Quick selection table (Molded Case Circuit Breakers)	14
Ratings	16
Accessories	20
Dimensions	36
Characteristics curves	38
Technical Information	41



Metasol
ABS 203c

250AF 3P
Ue 48V ~ 220/240V
Ics-icv 37kA ~ 85kA

Ics-100%icv
50/60Hz
Cat. A
CE
IEC60947-2
MADE IN KOREA

LINE

MCCB
U_{imp} 8kV
FMU

250A

LS
PUSH TO TRIP

I_n(A)
22.5
75-250

LOAD



Metasol

Adjustable MCCB



Metasol

Adjustable Molded Case Circuit Breaker

Adjustable **Metasol**

Low voltage circuit breaker

- $I_{cs} = 100\% \times I_{cu}$
- $U_i = 1,000V$
- $U_{imp} = 8kV$

125 AF



- $0.7 \dots 1 \times I_n$
- $37kA @ 415/460$
- $16 \dots 125A$

250 AF



- $0.7 \dots 1 \times I_n$
- $37kA @ 415/460$
- $100 \dots 250A$



Metasol MCCB System overview

■ Various installable Accessories

- Wider range of installable accessories compared to Meta MEC series.
- Composed of User Friendly Method.

System overview

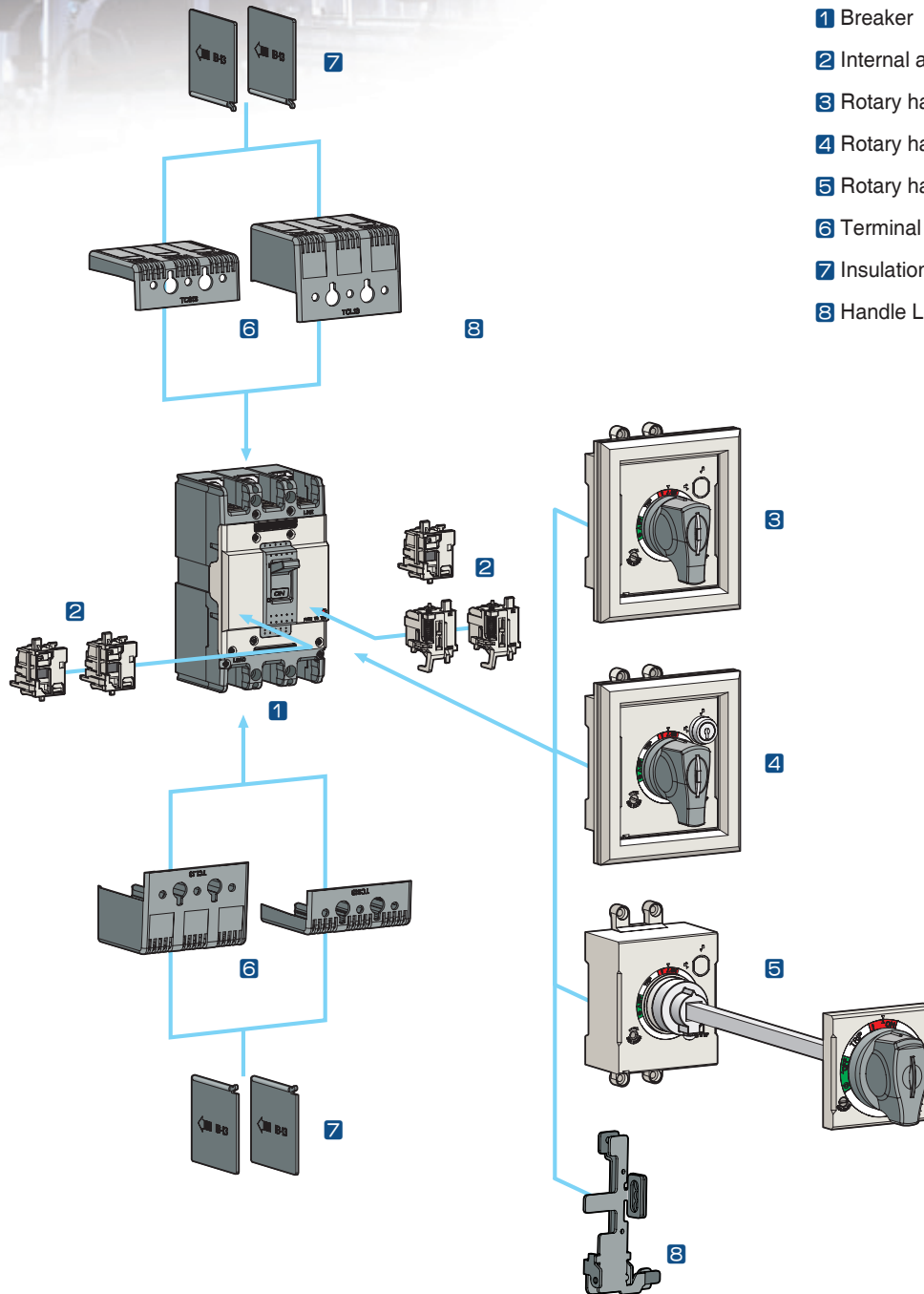

1 Breaker

2 Internal auxiliaries

3 Rotary handle (direct)

4 Rotary handle (direct, key lock)

5 Rotary handle (extended)

6 Terminal cover (Short, Long)

7 Insulation barrier

8 Handle Lock

Metasol MCCB Internal accessories



■ Various installable accessories

Internal Accessories can be commonly used in all Metasol MCCB

Common use to all Metasol MCCBs

Alarm Switch (AL)

Alarm switches offer provisions for immediate audio or visual indication of a tripped breaker due to overload, short-circuit, operation of shunt trip, or undervoltage trip conditions, operation of push button.

They are particularly useful in automated plants where operators must be signaled about changes in the electrical distribution system. This switch features a closed contact when the circuit breaker is tripped automatically. In other words, this switch does not function when the breaker is operated manually. Its contact is open when the circuit breaker is reset.



Auxiliary Switch (AX)

Auxiliary switch is for applications requiring remote "ON" and "OFF" indication. Each switch contains two contacts having a common connection. One is open and the other closed when the circuit breaker is open, and vice-versa.



Undervoltage trip (UVT)

The undervoltage trip automatically opens a circuit breaker when voltage drops to a value ranging between 35% to 70% of the line voltage. The operation is instantaneous, and the circuit breaker cannot be reclosed until the voltage returns to 85% of line voltage.

Continuously energized, the undervoltage trip must be operating before the circuit breaker can be closed.



Shunt Trip (SHT)

The shunt trip opens the mechanism in response to an externally applied voltage signal. LS shunt trips include coil clearing contacts that automatically clear the signal circuit when the mechanism has tripped. contact with live parts and thereby guarantee protection against direct contacts.

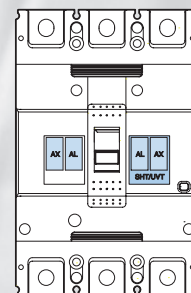
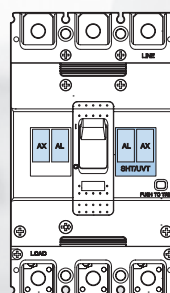

Metasol MCCB External accessories



■ External accessories

Designed for various mount and user safety.

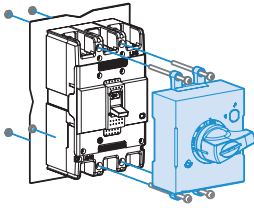

Direct & Extended Rotary Handle

There are two types of rotary handles.

- Direct rotary handle(with or w/o key lock device)
 - Extended rotary handle
-

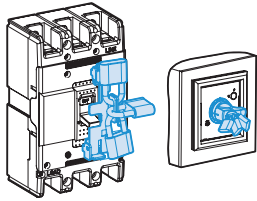

Locking device

- Fixed padlock
 - Removable padlock
 - Key lock device on direct handle
-

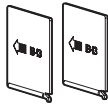

Insulation barrier

These allow the insulation characteristics between the phases at the connections to be increased.

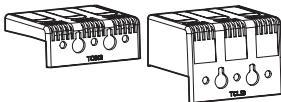

Insulation terminal cover

The terminal covers are applied to the circuit-breaker to prevent accidental contact with live parts and thereby guarantee protection against direct contacts.

Marking and configuration

MCCB

MCCB model

- ABS: Standard type

Standardized characteristics

- Ui: Rated insulation voltage
- Uimp: Impulse withstand voltage
- Ue: Rated operational voltage
- Icu: Ultimate breaking capacity
- Ics: Service breaking capacity



Rated frequency

Utilization category

Standard

Symbol indicating suitability for isolation as defined by IEC 947-2

MCCB

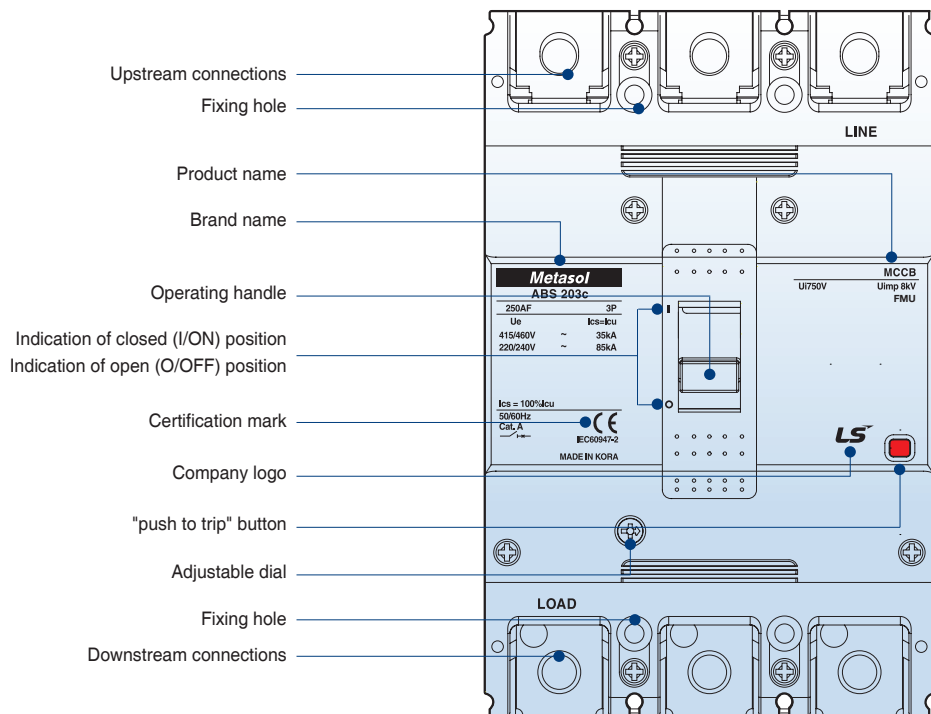

External configuration

MCCB

① Handle

- Function of indications
 - "ON" "OFF" "TRIP"
- Resetting

When the handle indicates "tripped" position it must first be reset by moving the handle to the "OFF" position and then closing is possible
- Trip-Free even if the handle is held at "ON", the breaker will trip if an over current flows
- Suitable for Verification of the main contact position under abnormal conditions because the handle doesn't indicate open position

② Arc-Extinguishing unit

- LS patent technique PASQ Arc-Extinguishing unit

PASQ : Puffer Assisted Self-Quenching
- Reduction of arc voltage for a short time

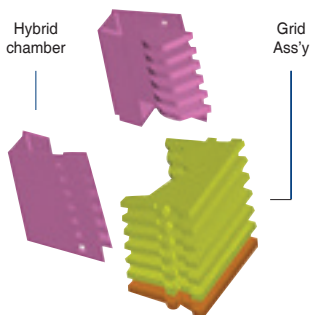

③ Trip button (push to trip)

- Enables tripping mechanically from outside, for confirming the operation of the accessory switches and the manual resetting function.

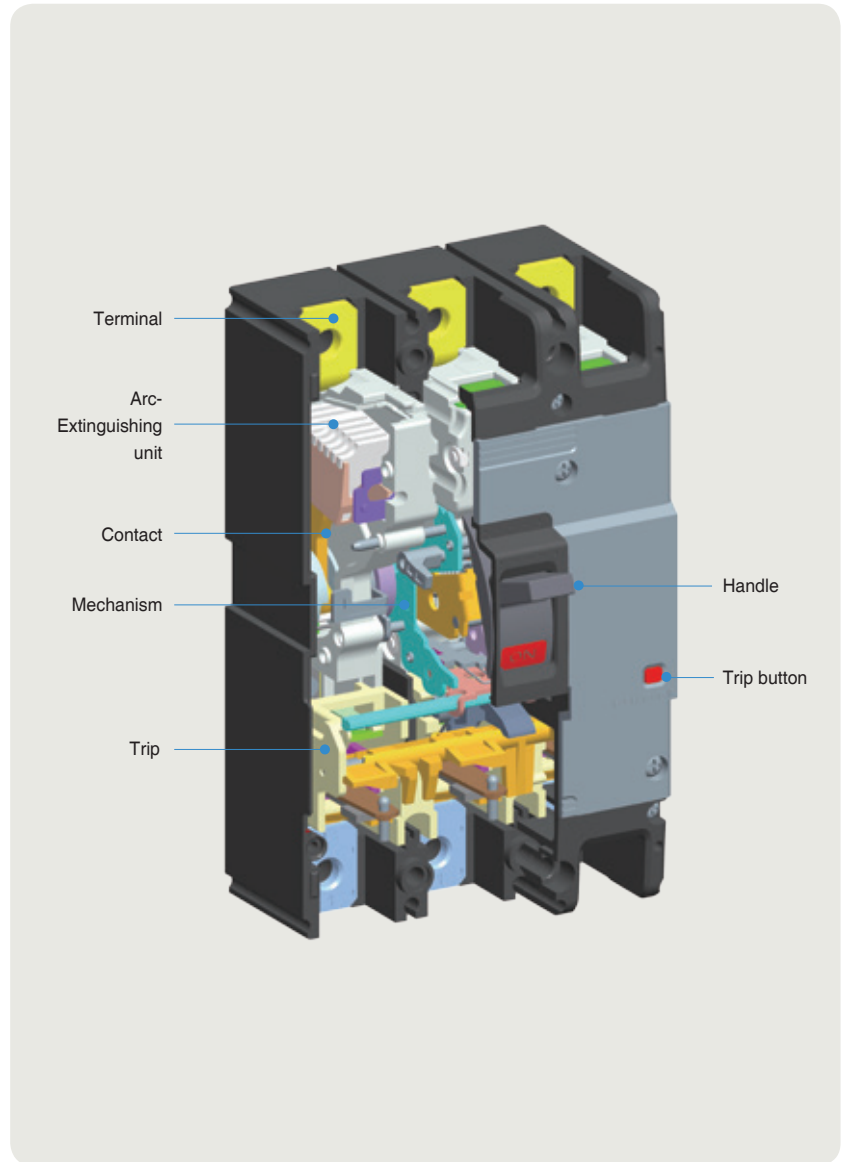

Application of PASQ Arc Extinguishing

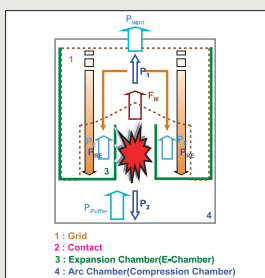

- The reduction of breaking time by applying PASQ arc extinguishing for inhibition of arc voltage for a short time.

Application of Current limiting structure

- Current limiting repulsion structure (U fixed structure)
- Toggle structure
 - When the operating unit repulses by short circuit current, repulsion structure at bigger angle.



Quick selection table

Molded Case Circuit Breakers



MCCBs

AF		125AF
Type		S-Type
	3-pole	ABS103c
	4-pole	ABS104c
Rated current, I _n	A	16, 20, 25, 32, 40, 50, 63, 80, 100, 125
	Adjustable Range	0.7 ... 1 × I _n Note 1
Rated operational voltage, U _e	AC(V)	415/460
Rated insulation voltage, U _i	V	1,000
Rated impulse withstand voltage, U _{imp}	kV	8
Rated short-circuit breaking capacity(I_{cu}) kA (Sym), IEC 60947-2		
	415/460V	37kA
	220/240V	85kA
I _{cs} =%×I _{cu}		100
Dimensions (mm) W×H×D	3-pole	90×155×60
	4-pole	120×155×60
Accessories	AX/AL	● (common use)
	SHT	● (common use)
	UVT	● (common use)
	D-Handle	● (common use)
	E-Handle	● (common use)
	N-Handle	● (common use)
	Plug-In	● (common use)
	Rear Connection (Bar, Round)	● (common use)
	Pad Lock	●
	Terminal Cover (Short Type)	● (common use)
	Terminal Cover (Long Type)	● (common use)

Note) 1. Adjustable range of 16A MCCB : 0.8~1×I_n

2. 4-Pole product's ampacity on neutral conductor is equal to or less than 50% of the rated current.



AF		250AF
Type		S-Type
	3-pole	ABS203c
	4-pole	ABS204c
Rated current, I _n	A	100, 125, 160, 200, 250
	Adjustable Range	0.7 ... 1 × I _n
Rated operational voltage, U _e	AC(V)	415/460
Rated insulation voltage, U _i	V	1,000
Rated impulse withstand voltage, U _{imp}	kV	8
Rated short-circuit breaking capacity(I_{cu}) kA (Sym), IEC 60947-2		
	415/460V	37kA
	220/240V	85kA
I _{cs} =%×I _{cu}		100
Dimensions (mm) W×H×D	3-pole	105×165×60
	4-pole	140×165×60
Accessories	AX/AL	● (common use)
	SHT	● (common use)
	UVT	● (common use)
	D-Handle	● (common use)
	E-Handle	● (common use)
	N-Handle	● (common use)
	Plug-In	● (common use)
	Rear Connection (Bar, Round)	● (common use)
	Pad Lock	●
	Terminal Cover (Short Type)	● (common use)
Terminal Cover (Long Type)	● (common use)	

Note) 4-Pole product's ampacity on neutral conductor is equal to or less than 50% of the rated current.

125AF MCCB

ABS125c

Ratings



ABS103e



ABS104e



ABS103c



ABS104c

Frame size		125AF			
Type and Pole		S-Type			
	3-pole	ABS103c			
	4-pole	ABS104c			
Rated current, I _n		16, 20, 25, 32, 40, 50, 63, 80, 100, 125			
Adjustable range		0.7 ...1 × I _n			
Rated operational voltage, U _e		AC: 415/460V			
Rated insulation voltage, U _i		AC: 1,000V			
Rated impulse withstand voltage, U _{imp}		8kV			
Rated short-circuit breaking capacity, I_{cu}		S-Type			
	415/460V	37kA			
	220/240V	85kA			
Protective function		Overload, Short-circuit			
Type of trip unit		Thermal-Magnetic			
Magnetic trip range		12×I _n (32A and under: 400A)			
Life cycle ^{Note4)}		Mechanical	25,000 operations		
		Electrical	10,000 operations		
Connection		Standard	Front connection		
Mounting		Standard	Screw fixing		
Dimensions (mm)		Pole	3p	4p	
		a	90	120	
		b	155		
		c1 ^{Note1)}	60		
		c2 ^{Note1)}	64		
		d	82		
		Weight, kg	Standard	1	
		Certification		Pole	3p
CE marking		CE	○		

Note) 1. Depth by door cut size: c1 for large cut, c2 for small cut
 2. 4-Pole product's ampacity on neutral conductor is equal to or less than 50% of the rated current.
 3. Adjustable range of 16A MCCB : 0.8-1×I_n
 4. Life cycle means not guarantee but limitation
 (Quality guarantee: On/Off frequency on the basis of IEC60947-2 within the term of guarantee.)

For more information

- Accessories ▶ 20 page
- Drawings ▶ 36 page
- Trip curves ▶ 38 page
- Connection and mounting ▶ 42 page

Ordering types

Breaker types

S type (37kA@415/460V)		
Rated current, In	3-pole	4-pole
16 A	ABS103c/16	ABS104c/16
20 A	ABS103c/20	ABS104c/20
25 A	ABS103c/25	ABS104c/25
32 A	ABS103c/32	ABS104c/32
40 A	ABS103c/40	ABS104c/40
50 A	ABS103c/50	ABS104c/50
63 A	ABS103c/63	ABS104c/63
80 A	ABS103c/80	ABS104c/80
100 A	ABS103c/100	ABS104c/100
125 A	ABS103c/125	ABS104c/125

Accessories

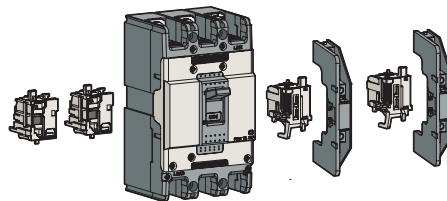

Electrical auxiliaries

AX	Auxiliary Switch
AL	Alarm Switch
AX+AL	Combination switch
SHT	Shunt Trip
UVT	Undervoltage trip



Maximum possibilities

T-position	One of above auxiliaries
R-position	Option of AX or AL or AX+AL

Note) For more detail see 21 page

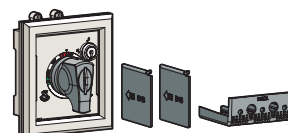
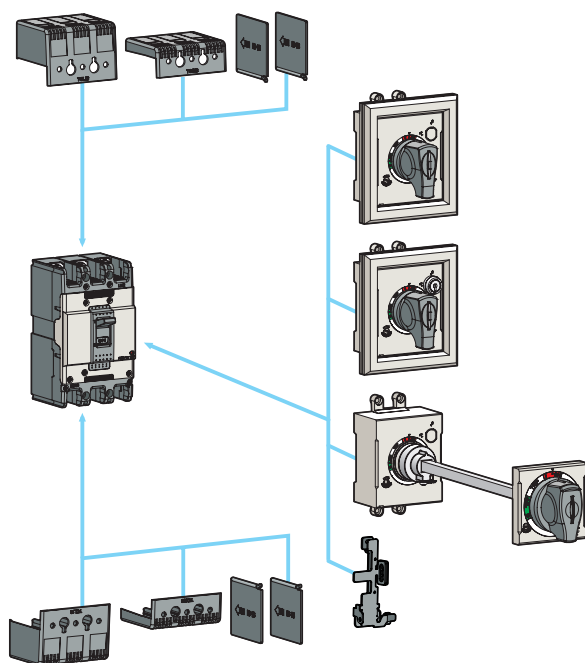

External accessories

ABS125c	Name
IB23	Insulation barrier
TCL23	Terminal cover (Long) - D-Handle type, N-Handle type
TCS23	Terminal cover (Short) - D-Handle type, N-Handle type
DH125	Rotary handle (Direct)
DHK125	Rotary handle (Direct, Key lock)
EH125	Rotary handle (Extended)
PHL125FMU	Pad Handle Lock

Note) For more detail see 25 page

- D-Handle type: This cover is used with D-Handle.
- N-Handle type: This cover is used with N-Handle.

250AF MCCB

ABS250c

Ratings



ABS203e



ABS204e



ABS203c



ABS204c

Frame size		250AF		
Type and Pole		S-Type		
	3-pole	ABS203c		
	4-pole	ABS204c		
Rated current, I _n		100, 125, 160, 200, 250		
Adjustable range		0.7 ... 1 × I _n		
Rated operational voltage, U _e		AC: 415/460V		
Rated insulation voltage, U _i		AC: 1,000V		
Rated impulse withstand voltage, U _{imp}		8kV		
Rated short-circuit breaking capacity, I_{cu}		S-Type		
	415/460V	37kA		
	220/240V	85kA		
Protective function		Overload, Short-circuit		
Type of trip unit		Thermal-Magnetic		
Magnetic trip range		12 × I _n		
Life cycle ^{Note3)}		Mechanical		
		20,000 operations		
		Electrical		
		5,000 operations		
Connection		Standard		
Mounting		Standard		
		Screw fixing		
Dimensions (mm)		Pole	3p	4p
		a	105	140
		b	165	
		c1 ^{Note1)}	60	
		c2 ^{Note1)}	64	
		d	87	
Weight, kg		Standard	1.2	1.6
Certification		Pole	3p	4p
CE marking		CE	O	

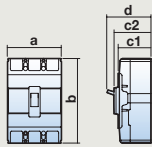

Note) 1. Depth by door cut size : c1 for large cut, c2 for small cut
 2. 4-Pole product's ampacity on neutral conductor is equal to or less than 50% of the rated current.
 3. Life cycle means not guarantee but limitation
 (Quality guarantee: On/Off frequency on the basis of IEC60947-2 within the term of guarantee.)

For more information

- Accessories ▶ 20 page
- Drawings ▶ 36 page
- Trip curves ▶ 38 page
- Connection and mounting ▶ 42 page

Ordering types

Breaker types

S type (37kA@415/460V)		
Rated current, In	3-pole	4-pole
100 A	ABS203c/100	ABS204c/100
125 A	ABS203c/125	ABS204c/125
160 A	ABS203c/160	ABS204c/160
200 A	ABS203c/200	ABS204c/200
250 A	ABS203c/250	ABS204c/250

Accessories

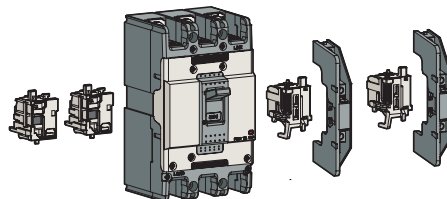

Electrical auxiliaries

AX	Auxiliary Switch
AL	Alarm Switch
AX+AL	Combination switch
SHT	Shunt Trip
UVT	Undervoltage trip



Maximum possibilities

T-position	One of above auxiliaries
R-position	Option of AX or AL or AX+AL

Note) For more detail see 21 page

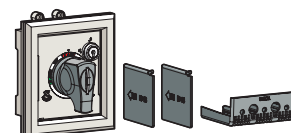
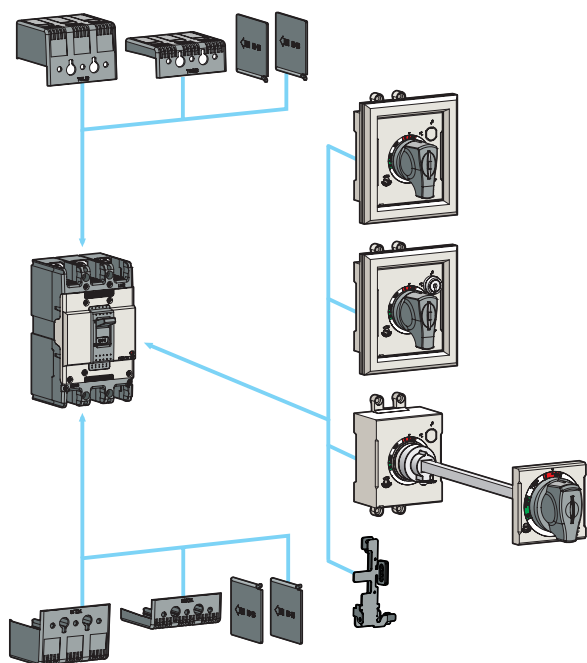

External accessories

ABS250c	Name
B33	Insulation barrier
TCL33	Terminal cover (Long) - D-Handle type, N-Handle type
TCS33	Terminal cover (Short) - D-Handle type, N-Handle type
DH250	Rotary handle (Direct)
DHK250	Rotary handle (Direct, Key lock)
EH250	Rotary handle (Extended)
PHL250FMU	Pad Handle Lock

Note) For more detail see 25 page

- D-Handle type: This cover is used with D-Handle.
- N-Handle type: This cover is used with N-Handle.

Electrical auxiliaries of 125~250AF

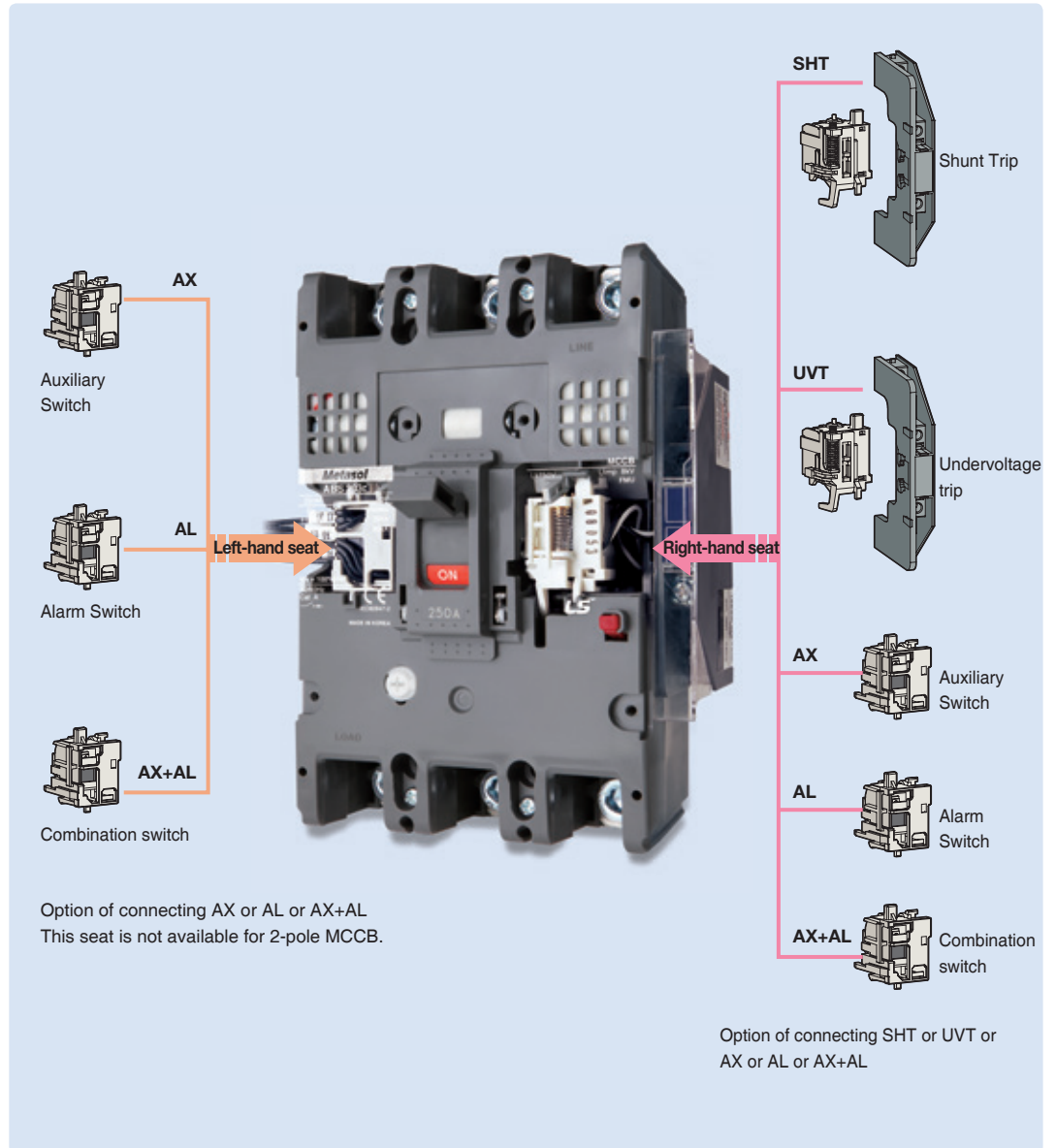

Maximum possibilities

Position	Type	3/4p
Left-hand seat	AX	1
	AL	1
	AX+AL	1
Right-hand seat	AX	1
	AL	1
	AX+AL	1
	SHT/UVT	1

Combinations of accessories

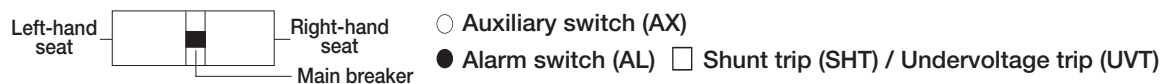

Series	MCCB (125~250AF)	Series	MCCB (125~250AF)
S-Type	ABS 103c/104c ABS 203c/204c	S-Type	ABS 103c/104c ABS 203c/204c
Pole	3, 4 Pole	Pole	3, 4 Pole
AX		AX+SHT(UVT)2	
AX2		AX2+SHT(UVT)	
AX3 (4)		AX2+SHT(UVT)2	
AL		AX3(4)+SHT(UVT)	
AL2		AX3(4)+SHT(UVT)2	
AL3(4)		AL+SHT(UVT)	
SHT(UVT)		AL+SHT(UVT)2	
SHT(UVT)2		AL2+SHT(UVT)	
AX+AL		AL2+SHT(UVT)2	
AX+AL2		AL3(4)+SHT(UVT)	
AX+AL3(4)		AL3(4)+SHT(UVT)2	
AX2+AL		AX+AL+SHT(UVT)	
AX2+AL2		AX+AL+SHT(UVT)2	
AX2+AL3(4)		AX2+AL2+SHT(UVT)	
AX3(4)+AL		AX2+AL2+SHT(UVT)2	
AX3(4)+AL2		AX3(4)+AL3(4)+SHT(UVT)	
AX3(4)+AL3(4)		AX3(4)+AL3(4)+SHT(UVT)2	
AX+SHT(UVT)			

Auxiliary and Alarm switch



Auxiliary switch (AX)

Auxiliary switch is for applications requiring remote “ON” and “OFF” indication. Each switch contains two contacts having a common connection. One is open and the other closed when the circuit breaker is open, and viceversa.



Alarm switch (AL)

Alarm switches offer provisions for immediate audio or visual indication of a tripped breaker due to overload, short circuit, shunt trip, or undervoltage release conditions. They are particularly useful in automated plants where operators must be signaled about changes in the electrical distribution system. This switch features a closed contact when the circuit breaker is tripped automatically. In other words, this switch does not function when the breaker is operated manually. Its contact is open when the circuit breaker is reset.

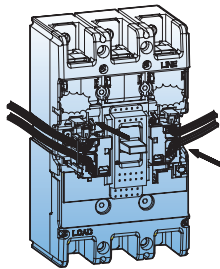

Combination switch (AX+AL)

It consists of one auxiliary switch (AX) and one alarm switch (AL) in a body to connect into the same position of the breaker.

Contact (AX+AL)

MCCB	ON	OFF	TRIP
AX			
AL			

Rating (AX+AL)

Conventional thermal current, I _{th}		5A	
Rated operational current, I _e	Voltage, U _e	Current, I _e	
		Resistive load	Inductive load
AC 50/60Hz	125V	5	3
	250V	3	2
	500V	-	-
DC	30V	4	3
	125V	0.4	0.4
	250V	0.2	0.2

Shunt trip, SHT

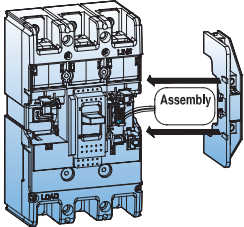

The shunt trip opens the mechanism in response to an externally applied voltage signal. The releases include coil clearing contacts that automatically clear the signal circuit when the breaker has tripped.



Rating for 125~250AF

Control voltage, Ue	Power consumption		MCCB
	AC (VA)	DC (W)	
DC 12V	-	1.5	Metasol MCCB ABS125c, ABS250c
AC/DC 24~30V	1.5	1.5	
AC/DC 48~60V	1.5	1.5	
AC/DC 100~130V	1.5	1.5	
AC/DC 200~250V	1.5	1.5	
AC 380~450V	1.5	-	
AC 440~500V	1.5	-	
Max. opening time	50ms (max.)		
Tightening torque of terminal screw	8.2 kgf·cm		

Note: 1. Range of operational voltage: 0.7 ~ 1.1Vn
Frequency (Only AC): 45Hz ~ 65Hz



Terminal block type (TBT)



Lead wire type (LWT)

Undervoltage release, UVT

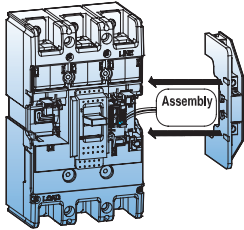

The undervoltage release automatically opens a circuit breaker when voltage drops to a value ranging between 20% to 70% of the line voltage. The operation is instantaneous, and after tripping, the circuit breaker cannot be re-closed again until the voltage returns to 85% of line voltage.

Continuously energized, the undervoltage release must be operating before the circuit breaker can be closed.

- Range of tripping voltage: 0.2 ~ 0.7Vn
- Reset and closing of a breaker is possible when the control voltage is over 0.85Vn
- Frequency (Only AC): 45Hz ~ 65Hz

Rating for 125~250AF



Control voltage, Ue		Power consumption		
		AC (VA)	DC (W)	mA
Voltage	AC/DC 24V	0.64	0.65	27
	AC/DC 48V	1.09	1.1	23
	AC/DC 100~110V	0.73	0.75	5.8
	AC/DC 200~220V	1.21	1.35	5.4
	AC 380~440V	1.67	-	3.8
	AC 440~480V	1.68	-	3.5
Max. opening time		50ms (max.)		
Tightening torque of terminal screw		8.2 kgf·cm		
Operating voltage range	Trip	20~70% Vn		
	Reset/Closing	≥ 0.85Vn		

Adjustable Mold Case Circuit Breaker

Adjustable to
Three level



Accessories

External accessories

Wide range of external accessories provides user-friendly solution for mounting, cable connection, insulation, safety lock and remote control.

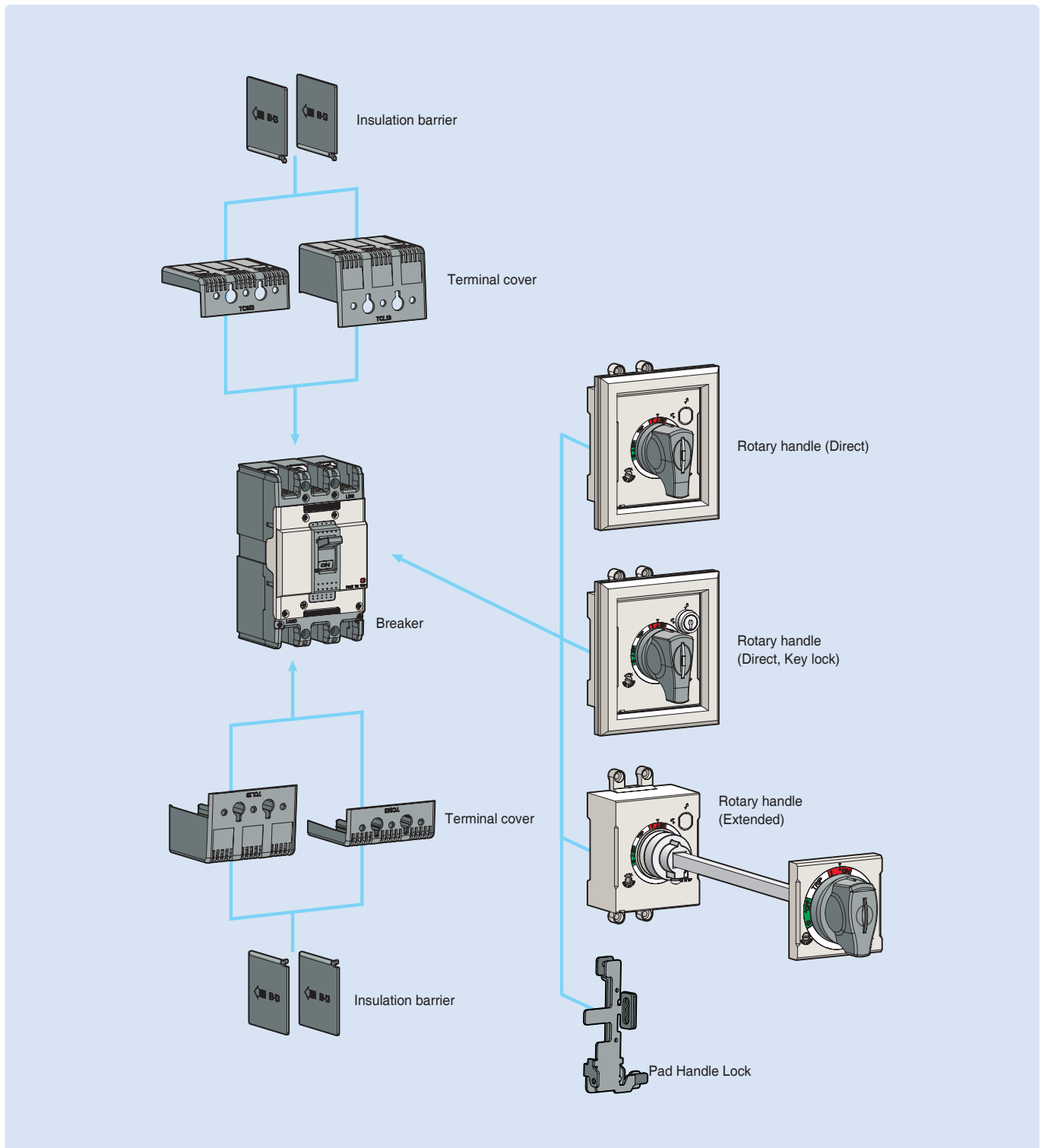

Rotary handles

Direct type



Direct type
(DH 125~250AF)



Key lock
(DH 125~250AF)



(N 125~250AF)

The rotary handle operating mechanism is available in either the direct version or in the extended version on the compartment door. It is always fitted with a compartment door lock and on a request it can be supplied with a key lock in the open position.

Direct type , D-handle and N-handle

- D-Handle : Directly mountable to a circuit breaker. Trip button is built as standard. Key lock type is optional.
- N-Handle : Directly mountable to a circuit breaker. Door is locked in the Off state. Handle size is greater than D-Handle.

Extended type, E-Handle

It is used in case direct type handle can not be applied because of the longer distance between the breaker and the panel door.

Type

Direct type	Direct type (Key lock)	Extended type	Breaker type
			MCCB
N-40c	-	-	ABS125c
DH125	DHK125	EH125	
N-50c	-	-	ABS250c
DH250	DHK250	EH250	

Note: Padlock type for N-handle
 - On or OFF state type - Only OFF state type

Extended type

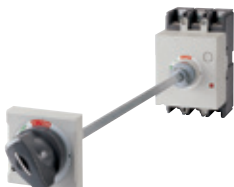

(125~250AF)

Type suffix according to the mounting position

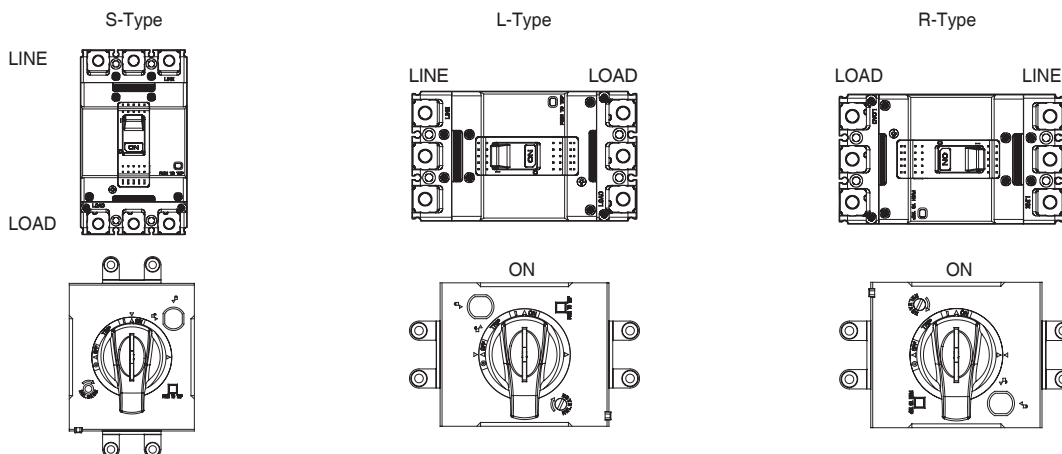

D-handle

MCCB and D-handle

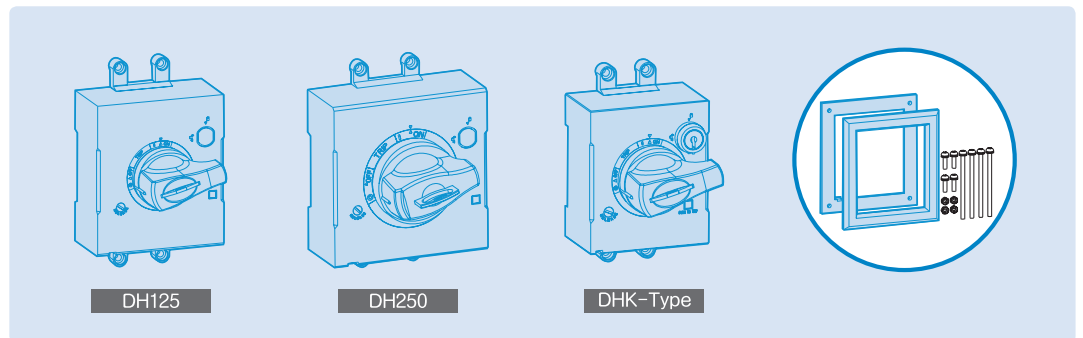
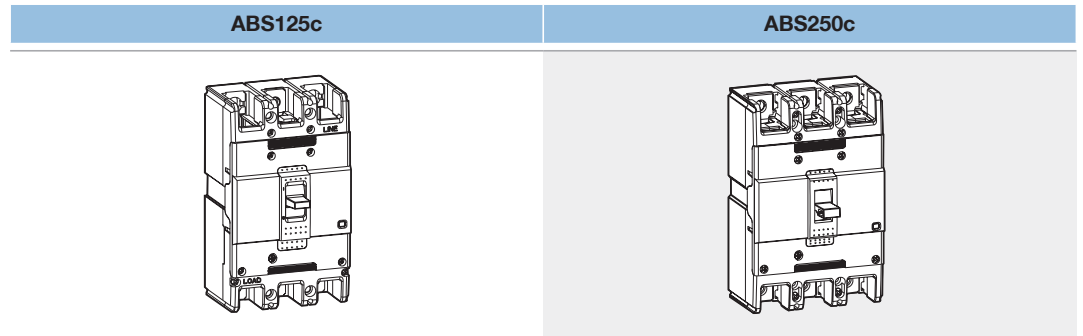

Tripping MCCB & Install type

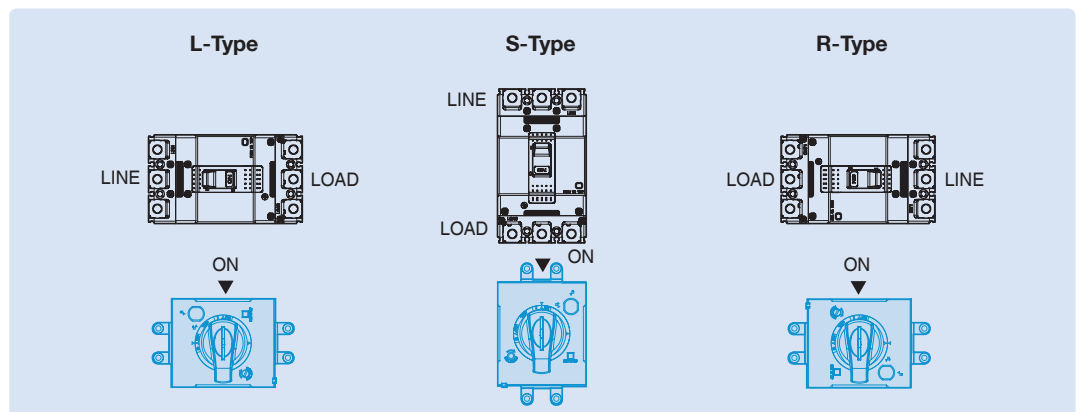
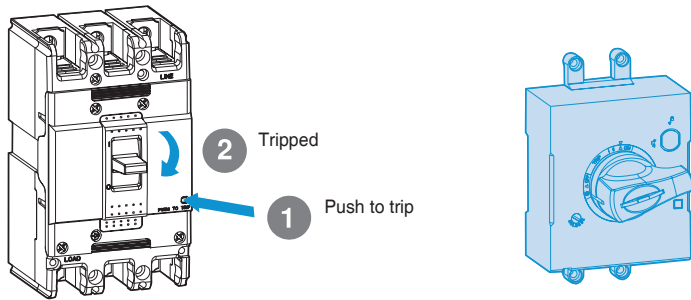

Installing the D-handle

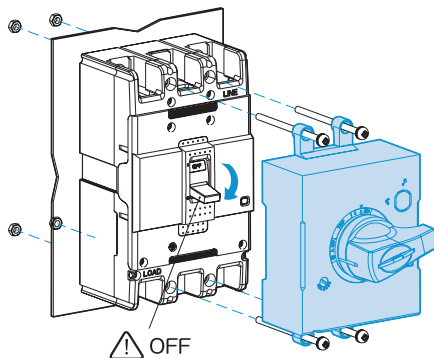

ABS125c	ABS250c

Cutting Panel

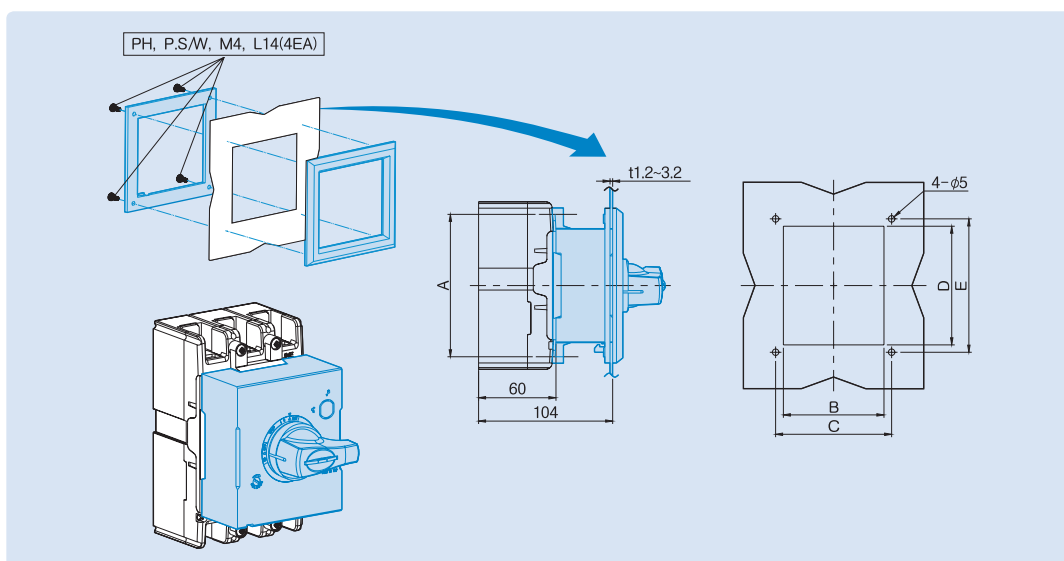

D-Handle	A (mm)	B (mm)	C (mm)	D (mm)	E (mm)	Breaker
DH125	132	94	105	108	120	125AF
DH250	126	108	121	110	122	250AF

Note) An extension shaft that must be adjusted to the distance between back of circuit breaker and door

D-handle

Operating test

CAUTION

If the door is opened with much pressure when the position of handle is ON or TRIP, the handle lock lever will be damaged.

TRIP position : Panel door can't be opened

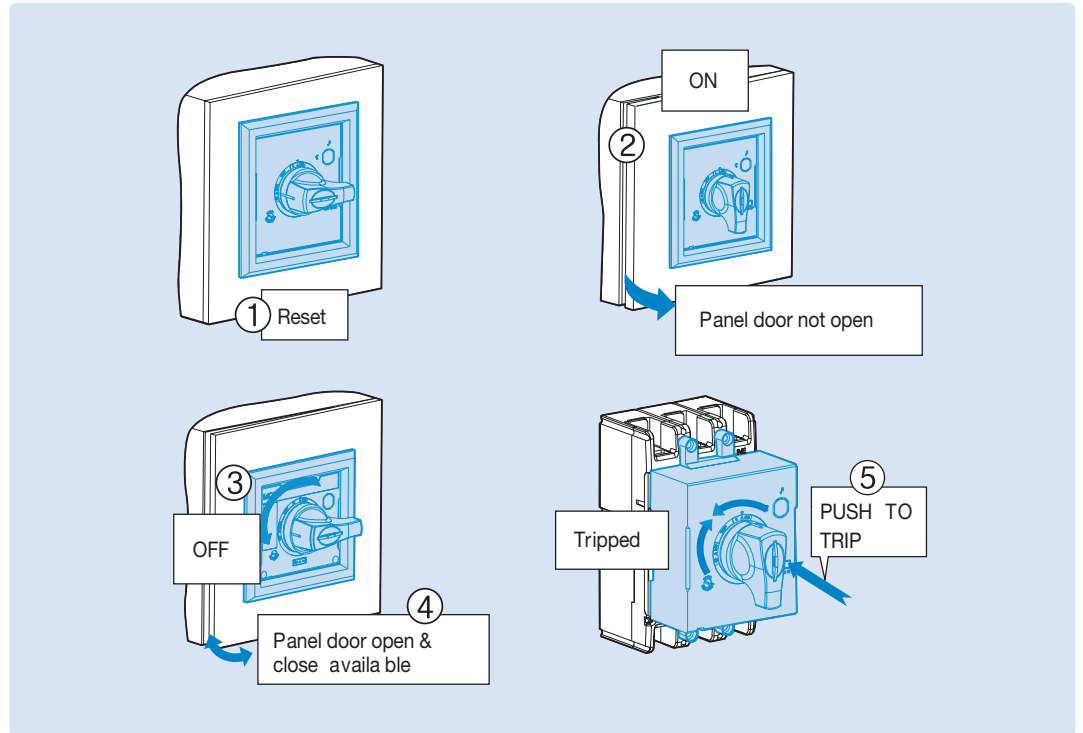

Locking system

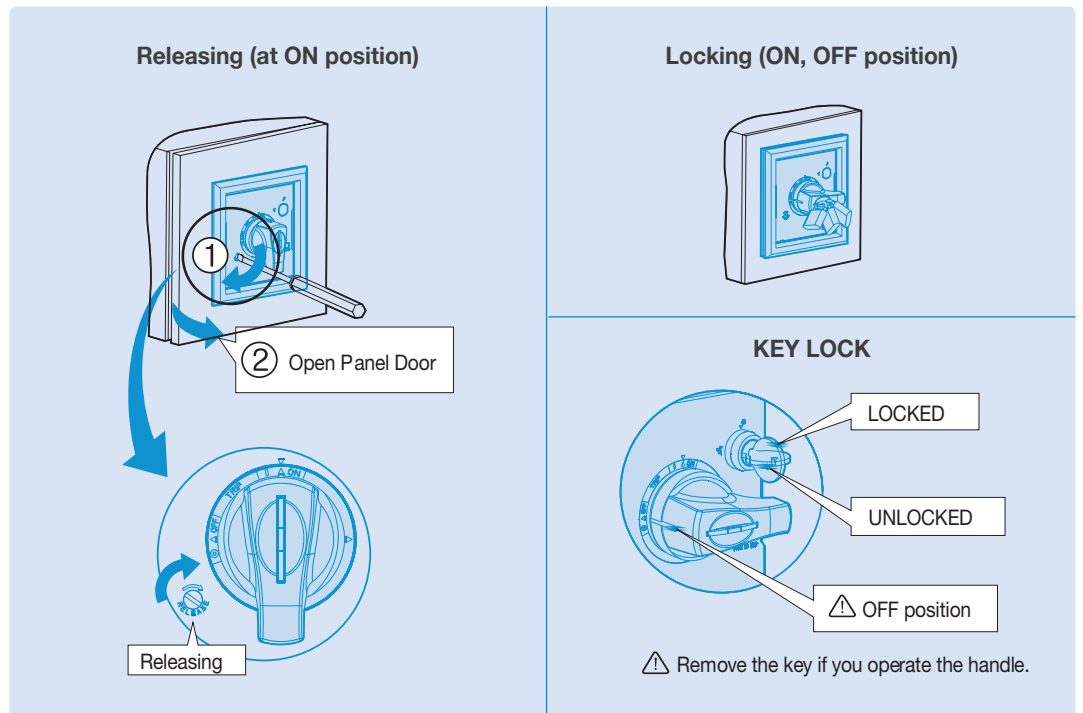

E-handle

MCCB and E-handle

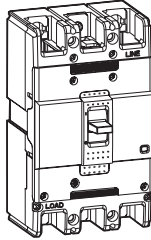
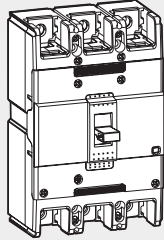
ABS125c	ABS250c
	

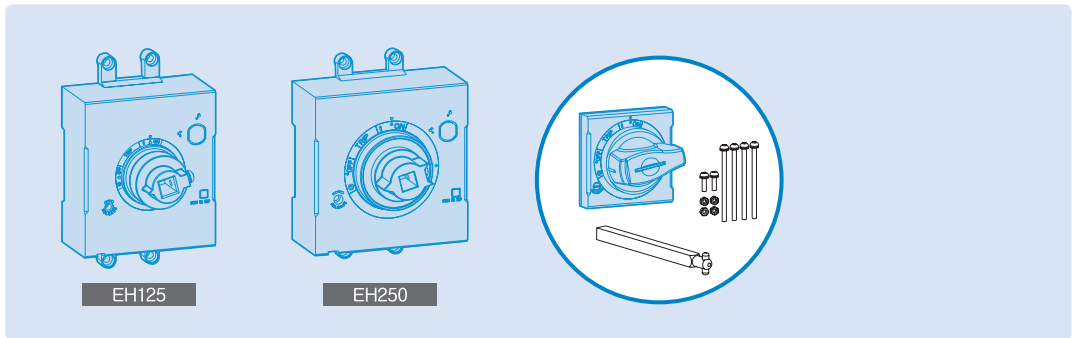

Tripping MCCB & Install type

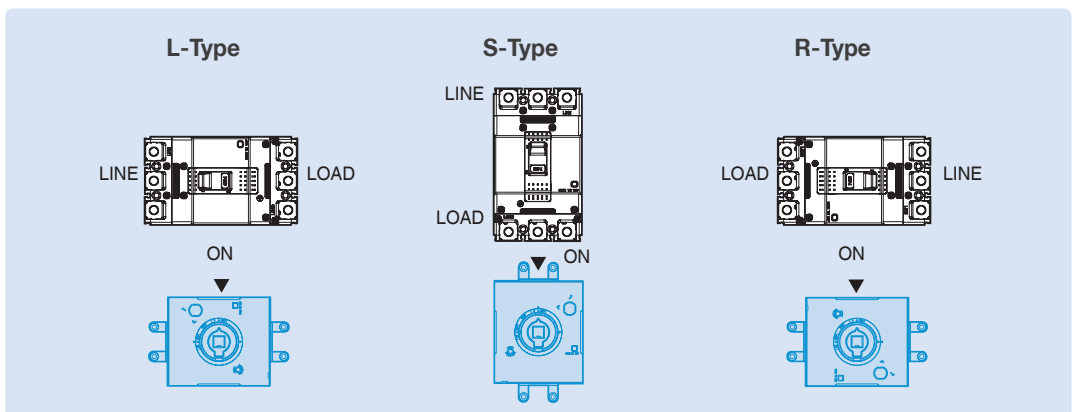
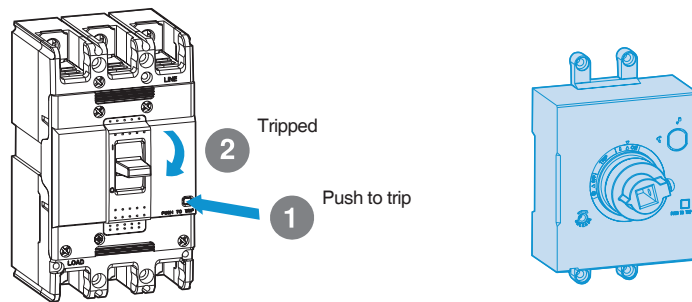

E-handle

Installing the E-handle

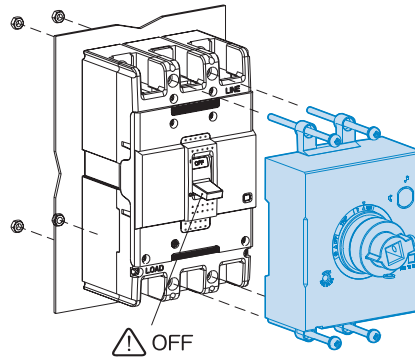

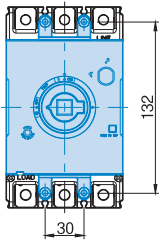
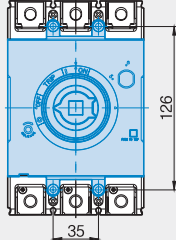
ABS125c	ABS250c
	

Operating Test

CAUTION

If the door is opened with much pressure when the position of handle is ON or TRIP, the handle lock lever will be damaged.

TRIP position : Panel door can't be opened

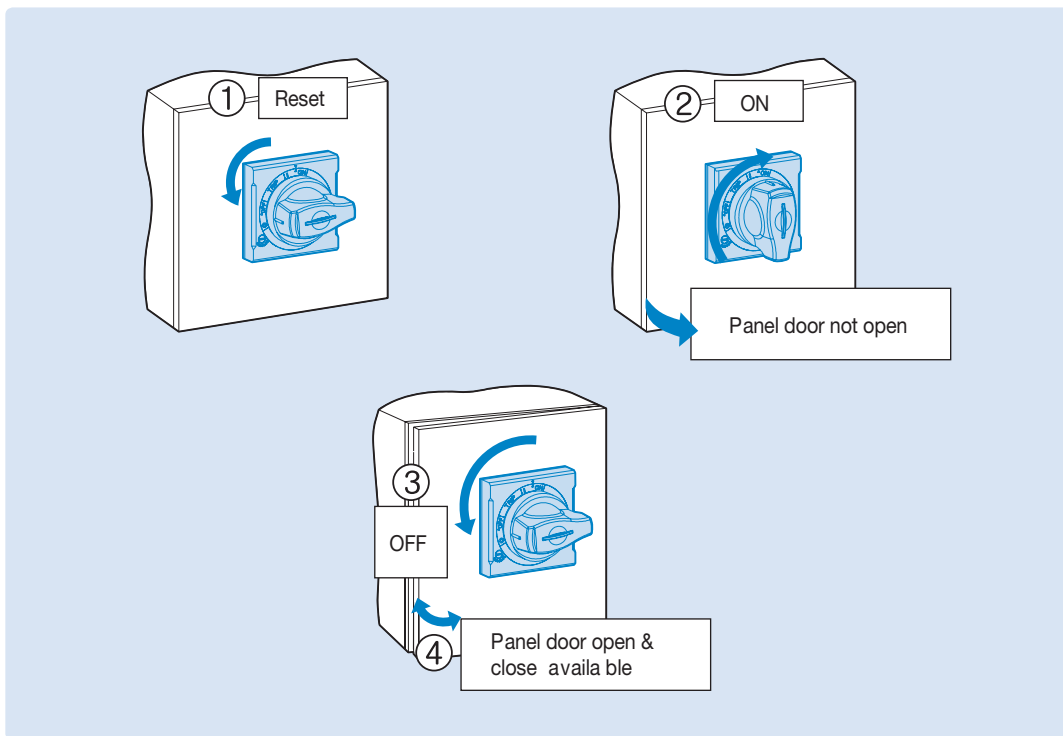

Locking System

Releasing (at ON position)

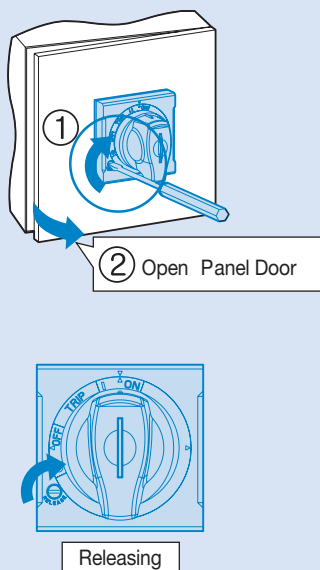

Locking (ON, OFF position)

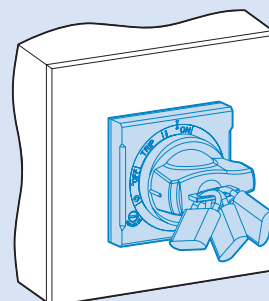

Terminal covers

The terminal covers are applied to the circuit-breaker to prevent accidental contact with live parts and thereby guarantee protection against direct contacts.

Two types by length are available and provide IP20 degree of protection.

Also, covers are classified in to 2 different type: Independent, Attachable and detachable with D or N Handle

- **Short type covers, TCS:**

For fixed circuit-breakers with rear terminals and for moving parts of plug-in.

- **Long type covers, TCL:**

For fixed circuit-breakers with front, front extended, front for cables terminals.

Terminal covers						Pole	Applied breaker	Size extended(A), mm	
Short type			Long type					MCCB	Short type
Inde	D-Handle	N-Handle	Inde	D-Handle	N-Handle				
TCS23	TCS23		TCL23	TCL23		3P	ABS250c	5.5	40
TCS24	TCS24		TCL24	TCL24		4P			
TCS33	TCS33		TCL33	TCL33		3P	ABS250c	5.5	50
TCS34	TCS34		TCL34	TCL34		4P			

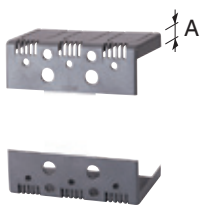

TCS(Short type)



Short type construction



TCL(Long type)



Long type construction

Insulation barriers



Insulation barrier allows the insulation characteristics between the phases at the connections to be increased. They are mounted from the front, even with the circuit-breaker already installed, inserting them into the corresponding slots.

They are incompatible with both the insulating terminal covers.

It is possible to mount the phase separating partitions between two circuit-breakers side by side.

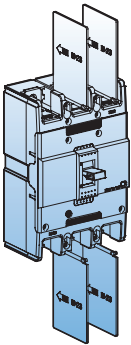

Type	Breaker
	MCCB
IB-23	ABS125c
	ABS250c



Insulation barriers for line side are provided as standard.

Dimensions

MCCB

ABS125c

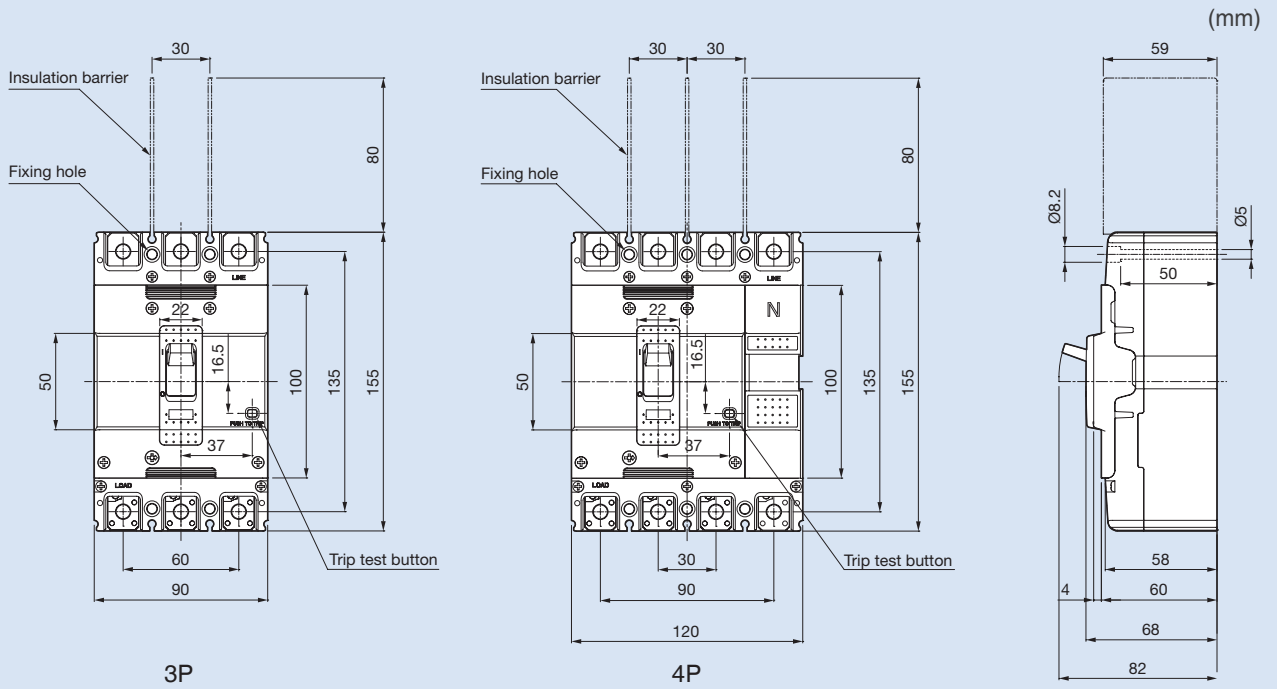

Terminal details

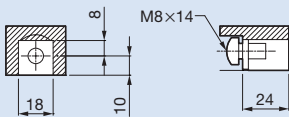

Connecting

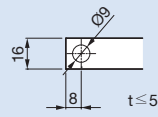

Panel drilling

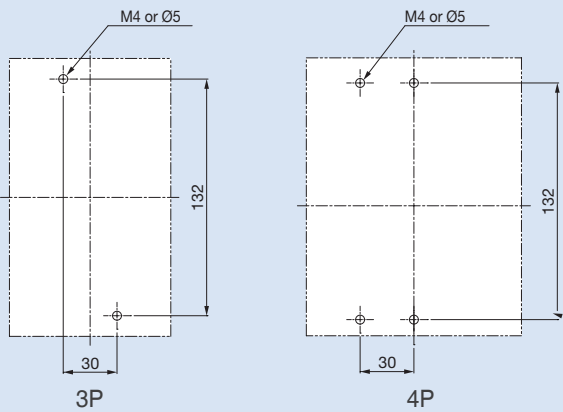

Front panel cutting

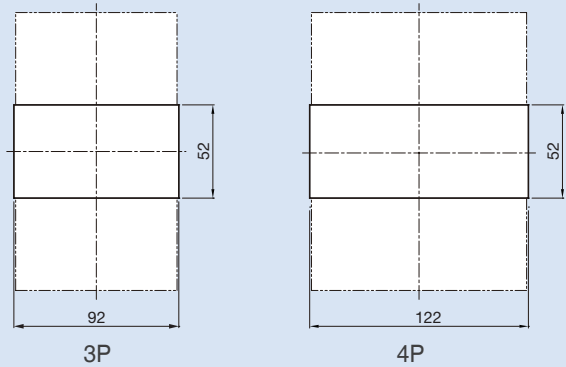

Dimensions

MCCB

ABS250c

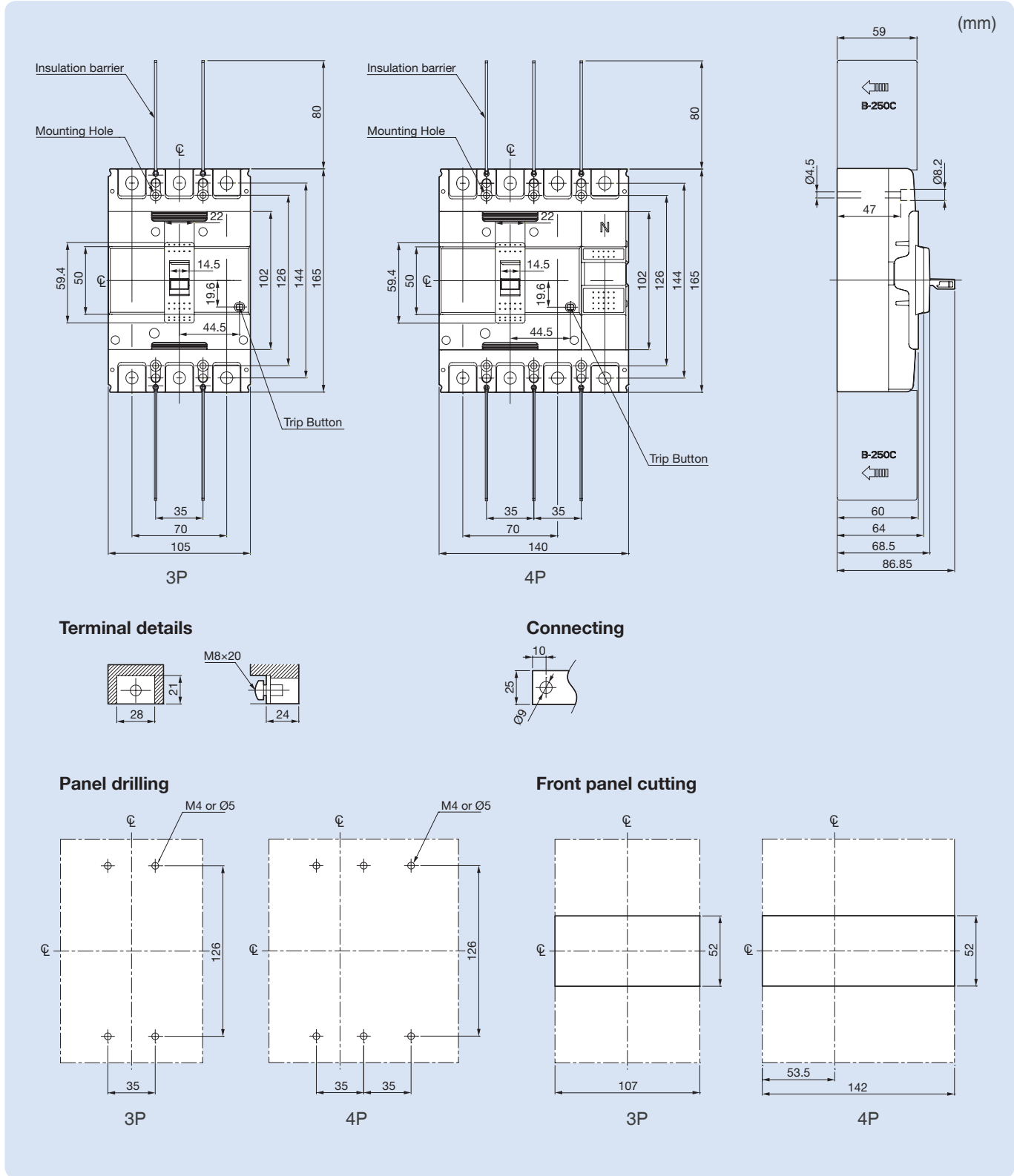

Characteristics curves

Breaker types

MCCB
ABS125c

Compensation curves

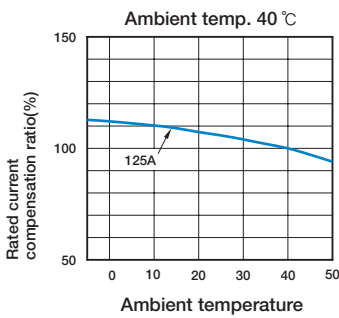

Rated current: 125A

Rated current: 125A

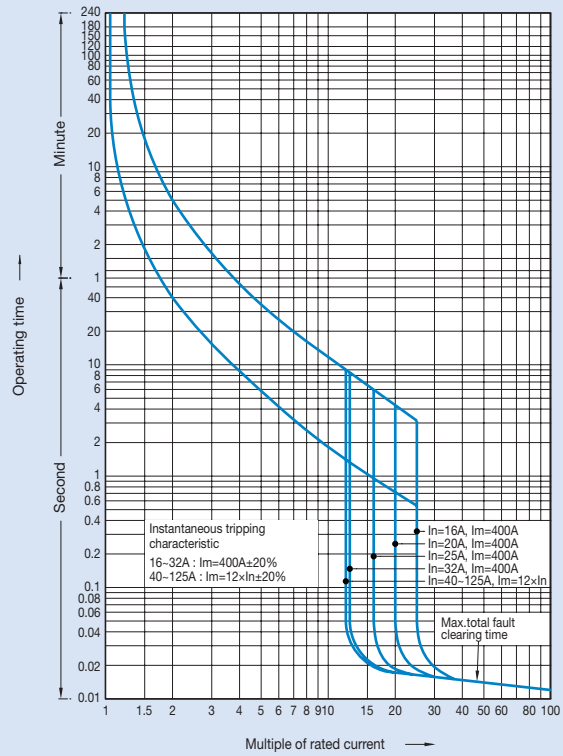

Breaker types

MCCB
ABS250c

Compensation curves

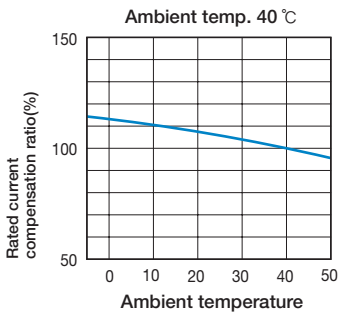

Rated current: 250A

Rated current: 250A

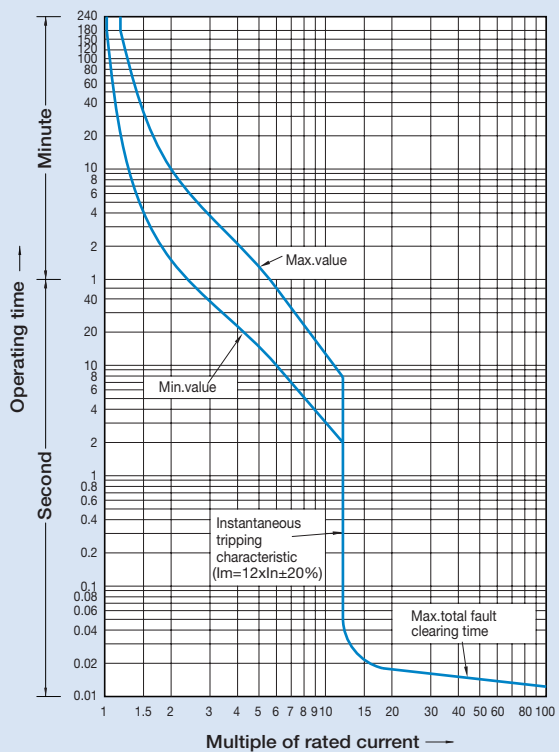

Dimensions

Rotary handles

Direct mounting type (D-Handle, 125~250AF)

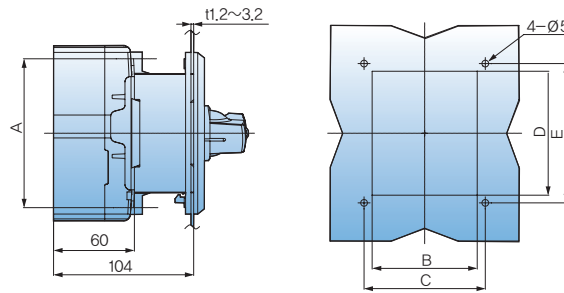

Type	A (mm)	B (mm)	C (mm)	D (mm)	E (mm)	Remarks
DH125	132	94	105	108	120	125AF
DH250	126	108	121	110	122	250AF

Direct mounting type (N-Handle, 125~250AF)

N-40c, 50c

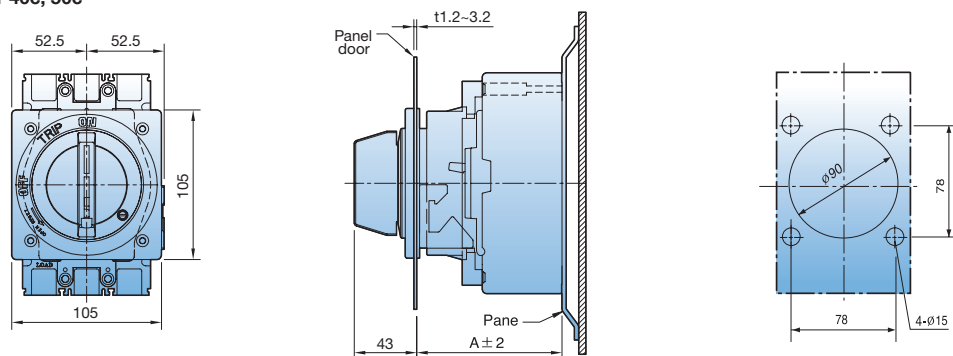

N-Handle	N-40c	N-50c
Note	125AF	250AF
A (mm)	103	103

Rotary handles

Extended mounting type (E-Handle) (125~250AF)

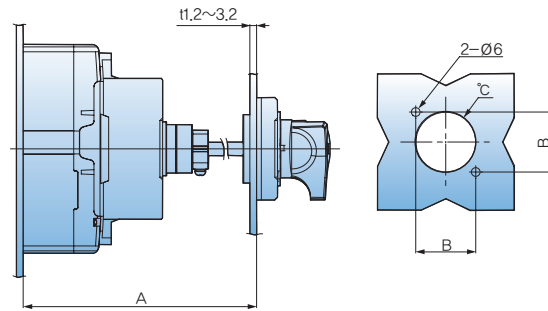







Type	A (mm)	D (mm)	E (mm)	Remarks
EH125	min 150, max 573.5 (SHAFT469mm)	108	120	125AF
EH250	min 150, max 571.5 (SHAFT469mm)	110	122	250AF

Note: 1. An extension shaft that must be adjusted to the distance.
 2. The min/max distance between the back of circuit breaker and door is 150-573.5 mm
 3. An extension shaft that must be adjusted to the distance between back of circuit breaker and door

Standard accessories

The following accessories for mounting, connection and insulation are standard items and are packed with Metasol series circuit breakers.

Item	125AF	250AF
Fixing screw		
	3P: 2EA (M4×60) 4P: 4EA (M4×60)	3P: 2EA (M4×55) 4P: 4EA (M4×55)
Terminal bolt		
	3P: 6EA (M8×14) 4P: 8EA (M8×14)	3P: 6EA (M8×20) 4P: 8EA (M8×20)
Insulation barrier		
	3P: 2EA 4P: 3EA	3P: 2EA 4P: 3EA

Fixing screws for rotary handles

Handle type	N-40c	N-50c
Applied MCCB	ABS 125c	ABS 250c
Fixing screw(short)	-	-
Fixing screw(long)	M4×85	M4×85

Handle type	DH/EH125	DH/EH250
Fixing screw	M4×70	M4×70

Connection

MCCB	Terminal (mm)	Tightening torque (kgf-cm)	Conductor (mm)
125AF		<p>M8 : 55 ~ 75</p>	
250AF		<p>M8 : 80 ~ 130</p>	

Safety clearance

When installing a circuit breaker, safety clearances must be kept between the breaker and panels, bars and other protection devices installed nearby. These safety clearances are depend on the ultimate breaking capacity and are defined by tests carried out in accordance with standard IEC 60947-2.

When a short circuit interruption occur, high temperatures pressures are present in and above the arc chambers of the circuit-breaker. In order to allow the pressure to be distributed and to prevent fire and arcing or short-circuit currents, safety clearances are required.

A: Minimum distance to metallic top panels

Frame size	Description	A(mm)	
		415/460V	220/240V
125AF	ABS125c	100	80
250AF	ABS250c	100	80

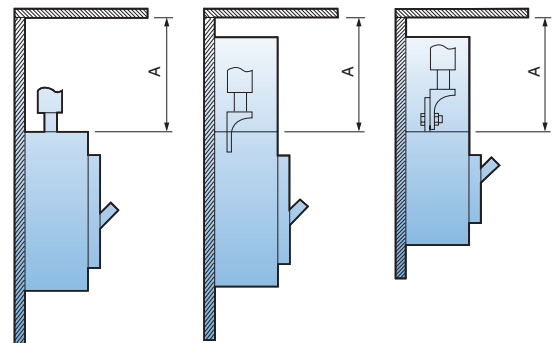

B: Minimum distance between the lower and the upper breakers

- C1: Minimum distance between the lower breaker and the bare terminal of the upper breaker
- C: C1+ the dimension of bare part of conductor

Frame size	Description	C1 (mm)		C (mm)
		415/460V	220/240V	
125AF	ABS125c	100	80	The dimension of bare conduct + C1
250AF	ABS250c	100	80	

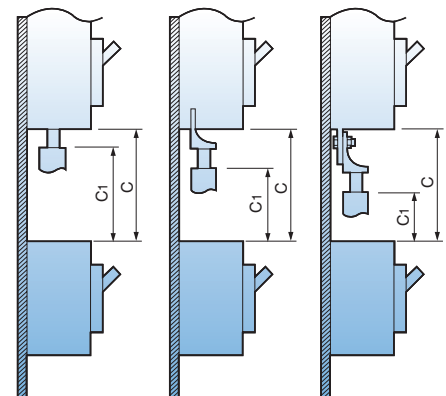

Direct connection of cable

Connection by using a crimp-type terminal lug

Connection by using a crimp-type terminal lug to the extended terminal

Safety clearance

Insulated length of main terminal of circuit breaker

- D1: Connection by solderless terminal with taping
- D2: Connection by busbar with taping
- D3: Connection by solderless terminal and using insulation barrier
- D4: Connection by busbar and using insulation barrier

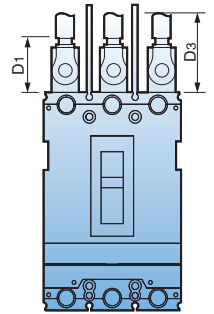

Frame size	Description	D1 (mm)	D2 (mm)	D3 (mm)	D4 (mm)
125AF	ABS125c	The dimension of bare conduct + 20	50	The dimension of bare conduct + 20	50
250AF	ABS250c		50		50

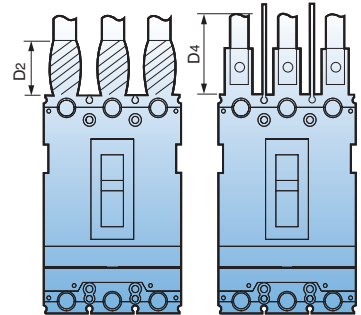

Minimum distance to metallic side panels

Frame size	Description	E(mm)	
		415/460V	220/240V
125AF	ABS125c	50	20
250AF	ABS250c	50	15

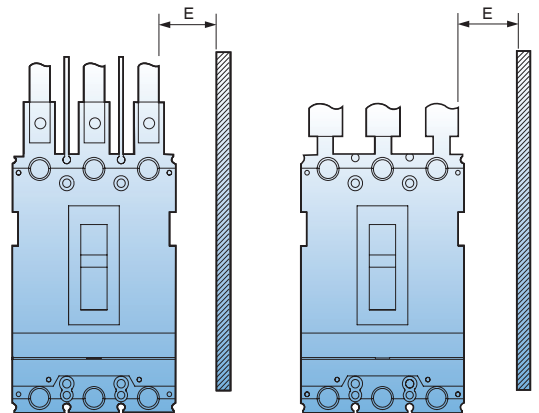

Safety clearance

Distance of bare cables or busbars

Frame size	Description	F(mm)
125AF	ABS125c	10
250AF	ABS250c	10

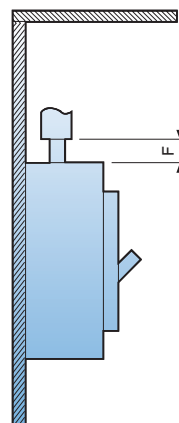

Minimal distance between two adjacent breakers (With terminal covers)

Frame size	Description	G(mm)
125AF	ABS125c	0
250AF	ABS250c	0

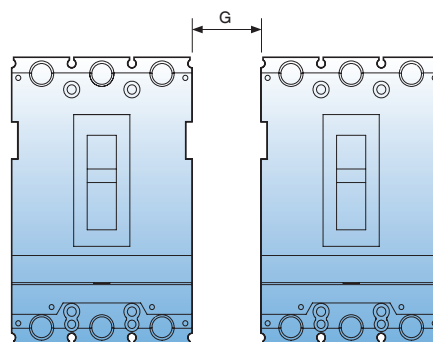

Standards & Approval

Metasol series circuit breakers and auxiliaries comply with the following international standard:

- IEC 60947-1
Low-voltage switchgear and controlgear - Part 1: General rules
- IEC 60947-2
Low-voltage switchgear and controlgear - Part 2: Circuit-breakers





The following certificates are available on a request.





- CE Declaration of conformity
- Certificate of conformance test (CB) - IEC 60947

CE conformity marking

The CE conformity marking shall indicate conformity to all the obligations imposed on the manufacturer, as regards his products, by virtue of the European Community directives providing for the affixing of the CE marking.

When the CE marking is affixed on a product, it represents a declaration of the manufacturer or of his authorized representative that the product in question conforms to all the applicable provisions including the conformity assessment procedures.

IEC SYSTEM OF CONFORMITY ASSESSMENT SCHEMES FOR ELECTROTECHNICAL EQUIPMENT AND COMPONENTS (IECEE) CB SCHEME		Ref. Certificate No.
 CB TEST CERTIFICATE		NL-36228
<p>IEC SYSTEM OF CONFORMITY ASSESSMENT SCHEMES FOR ELECTROTECHNICAL EQUIPMENT AND COMPONENTS (IECEE) CB SCHEME</p>		
Issued by: Product: Applicant: Manufacturer: Factory:	DEKRA Certification B.V. Moulded-Case Circuit Breaker LSIS Co., Ltd 127, LS-ro, Dongan-gu, Anyang-si, Gyeonggi-do 127, LS-ro, Dongan-gu, Anyang-si, Gyeonggi-do 95, Baekbong-ro, Heungdeok-gu, Cheongju-si, Chungcheongbuk-do	Korea, Republic of Korea, Republic of Korea, Republic of
Rating and principal characteristics:	Ue: 220 / 240 / 250 / 415 / 440 / 460 Vac, 50 / 60 Hz, Ui: 750 Vac, Uimp: 8 kV. In: 15 A, 20 A, 30 A, 40 A, 50 A, 60 A, 75 A, 100 A, 125 A for fixed overload release. In: 16 A, 20 A, 25 A, 32 A, 40 A, 50 A, 63 A, 80 A, 100 A, 125 A for adjustable overload release. 2P, 3P and 4P (unprotected N pole) for fixed overload release. 3P and 4P (unprotected N pole) for adjustable overload release Icu: 100 kA at 220 / 240 / 250 Vac, 50 kA at 415 / 440 / 460 Vac, for ABH series 85 kA at 220 / 240 / 250 Vac, 42 kA at 415 / 440 / 460 Vac for ABP series 85 kA at 220 / 240 / 250 Vac, 37 kA at 415 / 440 / 460 Vac for ABSxxx series 65 kA at 220 / 240 / 250 Vac, 26 kA at 415 / 440 / 460 Vac for ABSxxx series Ics = 100% Icu See annex for further ratings	
Trade mark (if any):	LS	
Model/Type reference:	ABH102c, ABH103c, ABH104c, ABH52c, ABH53c, ABH54c, ABP102c, ABP103c, ABP104c, ABP52c, ABP53c, ABP54c, ABS102c, ABS103c, ABS104c, ABS103c, ABS104c	
Additional information:	This certificate is also based on and replaces certificate no. NL-31877 issued on 2014-07-17.	
Sample of product tested to be in conformity with IEC:	60947-2(ed.4):am1:am2	
Test Report Ref. No.:	3307649.50, 3306469.50, 2109959.51 and 2116563.52/53	
This CB Test Certificate is issued by the National Certification Body:		
DEKRA Certification B.V. Meander 1051, 6825 MJ Arnhem The Netherlands		
Signed by: F. S. Strikwerda		
Date of issue: 2015-06-08		

IEC SYSTEM OF CONFORMITY ASSESSMENT SCHEMES FOR ELECTROTECHNICAL EQUIPMENT AND COMPONENTS (IECEE) CB SCHEME		Ref. Certificate No.
 CB TEST CERTIFICATE		NL-36229
<p>IEC SYSTEM OF CONFORMITY ASSESSMENT SCHEMES FOR ELECTROTECHNICAL EQUIPMENT AND COMPONENTS (IECEE) CB SCHEME</p>		
Issued by: Product: Applicant: Manufacturer: Factory:	DEKRA Certification B.V. Moulded-Case Circuit Breaker LSIS Co., Ltd 127, LS-ro, Dongan-gu, Anyang-si, Gyeonggi-do 127, LS-ro, Dongan-gu, Anyang-si, Gyeonggi-do 95, Baekbong-ro, Heungdeok-gu, Cheongju-si, Chungcheongbuk-do	Korea, Republic of Korea, Republic of Korea, Republic of
Rating and principal characteristics:	Ue: 220 / 240 / 250 / 415 / 440 / 460 Vac, 50 / 60 Hz, Ui: 750 Vac, Uimp: 8 kV. In: 100 A, 125 A, 150 A, 175 A, 200 A, 225 A, 250 A, for fixed overload release. In: 100 A, 125 A, 150 A, 200 A, 250 A, for adjustable overload release. 2P, 3P and 4P (unprotected N pole) for fixed overload release. 3P and 4P (unprotected N pole) for adjustable overload release Icu: 100 kA at 250 Vac, 50 kA at 460 Vac for ABH series 85 kA at 250 Vac, 42 kA at 460 Vac for ABP series 85 kA at 250 Vac, 37 kA at 460 Vac for ABSxxx series 65 kA at 250 Vac, 26 kA at 460 Vac for ABN and ABSxxx series Ics = 100% Icu See annex for further ratings	
Trade mark (if any):	LS	
Model/Type reference:	ABH202c, ABH203c, ABH204c, ABP202c, ABP203c, ABP204c, ABS202c, ABS203c, ABS204c, ABS203c, ABS204c, ABN202c, ABN203c, ABN204c	
Additional information:	This certificate is also based on and replaces certificate no. NL-31863 issued on 2014-07-17.	
Sample of product tested to be in conformity with IEC:	60947-2(ed.4):am1:am2	
Test Report Ref. No.:	3307650.50, 3306470.50, 2109959.52 and 2116563.54/55	
This CB Test Certificate is issued by the National Certification Body:		
DEKRA Certification B.V. Meander 1051, 6825 MJ Arnhem The Netherlands		
Signed by: F. S. Strikwerda		
Date of issue: 2015-05-28		

Standard Use Environment

Standard Use Environment for Molded Case Circuit Breaker

The operation characteristic of Molded Case Circuit Breaker including short-circuit, overload, endurance and insulation is often influenced largely by external environment and thus should be applied appropriately with conditions of the place where it is used taken into consideration. In particular, the operation characteristic of the circuit breaker with a thermal magnetic trip element (FTU, FMU, ATU) applied changes a bit with the ambient temperature so you have to adjust the value of power rating accordingly when it is actually in use.

- 1) Ambient Temperature: Within the range of -5°C ~ $+40^{\circ}\text{C}$ (However, the average for the duration of 24 hours must not exceed 35°C .)
- 2) Relative Humidity: Within the range of 45~85%
- 3) Altitude: 2,000m or less (However, if it exceeds 1,000m, atmosphere correction through humidity test and withstand voltage test can be considered.)
- 4) Atmosphere where excessive steam, oil steam, smoke, dust, salt and other corrosive materials do not exist



- If a standard circuit breaker is used in high temperature exceeding 40°C , you are advised to use it according to the current corrected for each level of ambient temperature in catalog.
- If used in conditions of highly humidity, the dielectric strength or electric performance may be degraded.



- There is no problem in conduction switch, trip or short circuit isolation in the temperature of -20°C .
- Passing or storage in stone-cold area is allowed in the temperature of 40°C .
- The operating characteristic of the breaker with a thermal magnetic trip element changes as the base ambient temperature is adjusted to 40°C .



- It is highly recommended to use a dust cover or anti-humid agent if it is used in dusty and humid conditions.
- Excessive vibration may cause a trip break such as connection fault or flaw on mechanical parts.



- If it is left ON or OFF for a long time, it is recommended to switch load current on a regular basis.
- It is recommend to put it in the sealed protection if corrosive gas is prevalent.

Special Use Environment

Environment where Ambient Temperature Exceeds 40°C

The temperature of each module of a Molded Case Circuit Breaker is the sum of temperature increase by conduction and ambient temperature and if the ambient temperature exceeds 40°C the passing current needs to be reduced so that the temperature of such element as internal insulator of MCCB exceed the maximum allowable temperature.

The base ambient temperature of Metasol breaker is set as 40°C so if it has to be used in conditions with higher temperature than this, the rated current is required to be reduced a little as described in the table below.

Table of Rated Current for Metasol MCCB Corrected according to Ambient Temperature

Model Name of Breaker	Rated current	Table of Rated Current Corrected according to Ambient Temperature (A)						
		10°C	20°C	30°C	40°C	45°C	50°C	55°C
ABS125c	16	16	16	16	16	15	15	14
	20	20	20	20	20	19	19	17
	25	25	25	25	25	24	23	21
	32	32	32	32	32	31	30	27
	40	40	40	40	40	39	37	34
	50	50	50	50	50	48	46	43
	63	63	63	63	63	61	58	54
	80	80	80	80	80	77	74	68
	100	100	100	100	100	97	93	86
ABS250c	125	125	125	125	125	121	116	107
	100	100	100	100	100	96	93	86
	125	125	125	125	125	121	117	107
	160	160	160	160	160	154	149	137
	200	200	200	200	200	193	186	171
	250	250	250	250	250	241	233	214

Special Use Environment

Environment where Ambient Temperature is -5°C or less

Molded Case Circuit Breaker is subject to the effect of low temperature brittle of metal part inside and insulator, or changes in viscosity of lubricating oil in device, extra care should be taken not to have the temperature drop extremely with the use of such device as space heater. In addition, in case of using a thermal magnetic trip element (FTU, FMU, ATU), the operating characteristic changes toward the difficult direction, so you should identify the relationship of protection and correct accordingly.

Although MCCB is not affected by conduction switch, trip, or short circuit isolation in the temperature of - 20°C, it is highly recommended to use a temperature maintaining device such as space heater.

In addition, transportation and passing in stone-cold area in the temperature as low as -40°C is allowed but it is recommend to leave the status of MCCB off or tripped in order to minimize the effect of brittle due to a low temperature.

High Humidity Condition (Relative Humidity 85% or more)

Using Molded Case Circuit Breaker in a place of high humidity requires a rigorous maintenance including installation of anti-humidity agent within the structure in order to prevent the insulation sag of insulator or corrosion of mechanical parts as a result of high humidity. Also, in case of installing MCCB within the enclosed equipment, a space heater needs to be installed as well to prevent dew condensation that might occur due to a drastic temperature change.

Environment where Petrochemical Gas Exists

The contact material of Molded Case Circuit Breaker is silver or silver alloy which develops creation of petrochemical coat that might cause a poor connection if it gets in contact with petrochemical gas.

However, it is easy for petrochemical coat to be mechanically taken off so it is no problem if make-and break operation occurs frequently but it needs to be switched back and forth between make and break if the operation rarely occurs.

The lead wire of moving contact of Molded Case Circuit Breaker can be disconnected as it is corroded or hardened by petrochemical gas. The silver coating is effective to prevent this from occurring and there is a need to increase durability of MCCB with the use of silver coated lead wire if it is used in environment with thick petrochemical gas.

Environment where Potentially Explosive Gas Exists

It is advised, in principle, not to install a Molded Case Circuit Breaker that switches and inhibits current in a dangerous place such as this one.

Impact of Altitude

If an MCCB is used in an elevated area higher than 2000m sea level, its operating performance is subject to dramatic drop in atmospheric pressure and temperature. For example, the air pressure is reduced to 80% of ordinary pressure at 2,200m and further 50% at 5,500m although the short-circuit performance is not affected.

If it is used in areas of high sea level, you can do correction based on the correction parameter table in high altitude environment, as described below.

[Correction Parameter Table for Altitude]

Altitude	Voltage Correction Parameter	Current Correction Parameter
2,000m	1.00	1.00
3,000m	0.91	0.98
4,000m	0.82	0.96
5,000m	0.73	0.94
6,000m	0.65	0.92

* Refer to the correction parameter table in high altitude environment (ANSI C37. 29-1970)

1) How to Correct Voltage:

- If the rated voltage is AC 600V at 4,000m above sea level,
 $600V \text{ (rated voltage)} \times 0.82 \text{ (correction parameter)} = 492V.$

2) How to Correct Current:

- If the rated current is AC 800A at above 4,000m sea level,
 $800A \text{ (rated current)} \times 0.96 \text{ (correction parameter)} = 768A.$

Environment with Vibration and Impulse Exercised

Impact of Vibration and Impulse

An excessive vibration and impulse may cause damage on breaker or other security problems including dynamic strength. An appropriate consideration is required to select a right MCCB for an adverse environmental stress such as this one. Moreover, this stress may incur from vibration during transportation, magnetic impulse while manipulating a switch or may be affected by equipment in surrounding area.

There is a standard call [Vibration Testing Method for Small Electric Appliances] for vibration and impulse test for electric equipment and the seismic and endurance tests of Molded Case Circuit Breaker are conducted in accordance with this standard, considering the circumstance mentioned above.

Vibration

The magnitude of vibration is measured by double amplitude and frequency with the following equation with accelerator.

$$\alpha g = 0.002 \times \text{frequency(Hz)} \times \text{double amplitude (mm)}$$

* αg : multiple of gravitational acceleration ($g=9.8\text{m/sec}^2$)

There are three types of vibration tests including resonance test, vibration endurance test, and malfunction test as described below.

1) Resonant Test

Alter the frequency of sinusoidal wave within the range of 0~55Hz gradually with 0.5~1mm of double amplitude applied to see if there is any occurrence of vibration on a specific part of MCCB.

2) Vibration Endurance Test

A sinusoidal wave with double amplitude of 0.5~1mm and frequency of 55Hz(resonant frequency obtained in previous clause if there is a resonant point) is manually created to check the operational status.

3) Malfunction Test

Apply vibration for 10 minutes for each condition of altering double amplitude and frequency to check if there is any malfunction in MCCB.

Impulse

The magnitude of impulse is denoted by the multiple of gravitational acceleration imposed on the equipment and part. The test is conducted through a drop impulse test.

Impact of High Frequency

In case of high frequency current, you are required to reduce the rated current of the breaker with a thermal magnetic trip element embedded due to heat incurred by the skin effect of conductor and/or core loss of structure. The reduction rate varies according to the Frame Size and rated current and decreases down to 70~80% at 400Hz. In addition, the core loss decreases attractive force, which leads to increase of instantaneous trip current.

* Core loss: It refers to the electrical loss in a transformer caused by magnetization of the core that changes over time and is categorized into hysteresis loss and eddy current loss.

* Hysteresis loss: It takes up the majority portion of no-load loss of electric equipment and is calculated like this.

$$P_h = \sigma f B_m n$$

B_m : maximum value of magnetic flux density, n : constant(1.6~2.0), f : frequency, σ : hysteresis constant

* Eddy current: It refers to an induced electric current formed within the body of a conductor when it moves through a non-uniform or changing magnetic field. The eddy current that incurs at winding of transformer or core is considered as one of the transformer losses as a part of exciting current. It is also called 'eddy current loss'.

Use Environment with Vibration and Impulse Applied

[Table of Seismic Performance and Internal Impulse Performance]

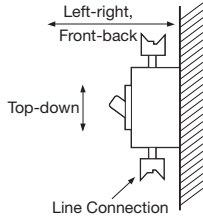
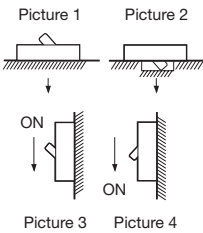
		Test	Internal Impulse
Test Condition	Mounting Vibration, Direction of impulse	<ul style="list-style-type: none"> Vertical mounting Top-down, Left-right, Front-back 	<ul style="list-style-type: none"> Picture 1, 2, 3, 4 (→ represents the direction of drop) 
	Status of MCCB	(1) Non-conduction (ON or OFF status) (2) Status where rated current is conducted until the temperature of MCCB becomes constant and keeps being conducted	Non-conduction (ON or OFF status)
Test Result	Judgment Condition	<ul style="list-style-type: none"> If it is ON, it should not be OFF If it is OFF, it should not be ON No abnormal status such as damage, transformation, or annealing of nut part Characteristics of switch and trip after the test must be normal 	



Safety Instructions

- For your safety, please read user's manual thoroughly before operating.
- Contact the nearest authorized service facility for examination, repair, or adjustment.
- Please contact qualified service technician when you need maintenance. Do not disassemble or repair by yourself!
- Any maintenance and inspection shall be performed by the personnel having expertise concerned.



- According to The WEEE Directive, please do not discard the device with your household waste.



www.ls-electric.com

■ **Headquarter**

127 LS-ro (Hogye-dong) Dongan-gu, Anyang-si, Gyeonggi-Do, 14119, Korea

■ **Seoul Office**

LS Yongsan Tower, 92, Hangang-daero, Yongsan-gu, Seoul, 04386, Korea
Tel. 82-2-2034-4916, 4684, 4429

■ **Overseas Subsidiaries**

- **LS ELECTRIC Japan Co., Ltd. (Tokyo, Japan)**
Tel: 81-3-6268-8241 E-Mail: japan@ls-electric.com
- **LS ELECTRIC (Dalian) Co., Ltd. (Dalian, China)**
Tel: 86-411-8730-5872 E-Mail: china.dalian@ls-electric.com.cn
- **LS ELECTRIC (Wuxi) Co., Ltd. (Wuxi, China)**
Tel: 86-510-6851-6666 E-Mail: china.wuxi@ls-electric.com.cn
- **LS ELECTRIC Vietnam Co., Ltd. (Hanoi, Vietnam)**
Tel: 84-222-2221-110 E-Mail: vietnam@ls-electric.com
- **LS ELECTRIC Middle East FZE (Dubai, U.A.E.)**
Tel: 971-4-886-5360 E-Mail: middleeast@ls-electric.com
- **LS ELECTRIC Europe B.V. (Hoofddorp, Netherlands)**
Tel: 31-20-654-1424 E-Mail: europartner@ls-electric.com
- **LS ELECTRIC America Inc. (Chicago, USA)**
Tel: 1-800-891-2941 E-Mail: sales.us@lselectricamerica.com
- **LS ENERGY SOLUTIONS LLC (Charlotte, USA)**
Tel: 1-704-587-4051 E-Mail: cmfeldman@ls-es.com
- **LS ELECTRIC Türkiye Co., Ltd. (Istanbul, Türkiye)**
Tel: 90-212-806-1252 E-Mail: turkiye@ls-electric.com
- **LS ELECTRIC IBERIA S.L.U. (Madrid, Spain)**
Tel: 34-910-28-02-74 E-Mail: iberia@ls-electric.com

■ **Overseas Branches**

- **LS ELECTRIC Tokyo Office (Japan)**
Tel: 81-3-6268-8241 E-Mail: tokyo@ls-electric.com
- **LS ELECTRIC Beijing Office (China)**
Tel: 86-10-5095-1631 E-Mail: china@lselectric.com.cn
- **LS ELECTRIC Shanghai Office (China)**
Tel: 86-21-5237-9977 E-Mail: china@lselectric.com.cn
- **LS ELECTRIC Guangzhou Office (China)**
Tel: 86-20-3818-2883 E-Mail: china@lselectric.com.cn
- **LS ELECTRIC Chengdu Office (China)**
Tel: 86-28-8670-3201 E-Mail: china@lselectric.com.cn
- **LS ELECTRIC Qingdao Office (China)**
Tel: 86-532-8501-2065 E-Mail: china@lselectric.com.cn
- **LS ELECTRIC Nanjing Office (China)**
Tel: 86-25-8467-0005 E-Mail: china@lselectric.com.cn
- **LS ELECTRIC Bangkok Office (Thailand)**
Tel: 66-90-950-9683 E-Mail: thailand@ls-electric.com
- **LS ELECTRIC Jakarta Office (Indonesia)**
Tel: 62-21-2933-7614 E-Mail: indonesia@ls-electric.com
- **LS ELECTRIC Moscow Office (Russia)**
Tel: 7-499-682-6130 E-Mail: info@lselectric-ru.com
- **LS ELECTRIC America Western Office (Irvine, USA)**
Tel: 1-949-333-3140 E-Mail: america@ls-electric.com
- **LS ELECTRIC India Office (India)**
Tel: 91-80-6142-9108 E-Mail: info_india@ls-electric.com
- **LS ELECTRIC Singapore Office (Singapore)**
Tel: 65-6958-8162 E-Mail: singapore@ls-electric.com