

Susol *Super Solution*

Compact ACB

Compact Air Circuit Breakers

INSTRUCTION MANUAL



INSTRUCTION MANUAL OF Compact ACB



LS IS

www.lsis.com

Instruction manual of Compact ACB

A. Safety precaution	A-1
1. Safety precaution	A-1
2. Caution	A-2
3. Danger	A-2
4. Warning	A-3
B. Service condition	B-1
1. Normal/Special service condition	B-1
2. Altitude and Insulation clearance	B-2
C. Structure and operation	C-1
1. Internal structure and components	C-1
2. Basic function and breaking operation	C-3
D. Types and ratings	D-1
1. Types of Susol series	D-1
2. Types of OCR/Cradle series	D-3
3. Ratings	D-4
E. Weight & Dimension	E-1
1. Weight & dimension	E-1
2. Dimension	E-2
F. Unpacking	F-1
1. Receiving	F-1
2. Unpacking	F-1
3. Check point and caution	F-2
G. Handling and storage	G-1
1. Handling	G-1
2. Storage	G-2
H. Installation	H-1
1. Fixed type	H-1
2. Draw-out type	H-1
3. Precaution and installation of insulation barrier	H-2
4. BUS-BAR connection	H-3
I. Operation	I-1
1. Manual operation	I-1
2. Electrical operation	I-2
3. Draw-in operation	I-2
4. Draw-out operation	I-4
5. Mechanism operation by draw in/out section	I-5

Instruction manual of Compact ACB

J. Trip relay externals and configuration	J-1
1. Setting of ratings	J-1
2. Knob setting	J-2
3. Connector	J-3
4. Key and LED configuration	J-4
K. Trip relay setting	K-1
1. Protection	K-1
2. Operation Characteristics	K-4
L. The operation of trip relay	L-1
1. Menu tree	L-1
2. LCD segment	L-1
3. Button configuration	L-2
4. Measurement display	L-2
5. Relay setting display	L-3
M. Characteristics curves	M-1
1. Long-time protection	M-1
2. Short-time protection	M-2
3. Instantaneous/Ground-fault protection	M-3
4. IDMTL	M-4
N. Inspection and troubleshooting	N-1
1. Inspection and maintenance cycle	N-1
2. Defects and troubleshooting guideline	N-2
O. Wiring diagram of control circuit	O-1

1. Safety precaution

Outline for safety operation

This manual does not cover all possible contingencies, variations and details that may arise during installation, operation or maintenance of this equipment. If the user has questions regarding a particular installation, contact the local LSIS sales office. For application information, consult your nearest LSIS sales office.

The information contained herein is general in nature and not intended for specific application purposes. It does not relieve the user of responsibility to use sound practices in application, installation, operation, and maintenance of the equipment purchased. LSIS's reserves the right to make changes in the specifications shown herein or to make improvements at any time without notice or obligations. If a conflict arise between the general information contained in this publication and the contents of drawings or supplementary material or both, the latter shall take precedence.

Qualified person

For the purpose of this manual and product labels, a qualified person with suitable knowledge of installation, construction, operation, or maintenance of the equipment and the hazards involved. In addition, this person has the following qualifications:

- 1) is trained and authorized to energize, de-energize, clear, ground, and connect circuits and equipment in accordance with established safety practices.
- 2) is trained in the proper care and use of protective equipment such as rubber gloves, hard hat, safety glasses or face shields, flash clothing, etc., in accordance with safety practices.
- 3) is trained in rendering first aid. These instructions do not cover all details or variations in equipment, nor to provide for every possible contingency to be met in connection with installation, operation, or maintenance. In case particular problems arise which are not covered sufficiently for the purchaser's purposes further information should be desired or the matter should be referred to the local LSIS's sales office. The contents of this instruction manual shall not become part of or modify any prior or existing agreement, commitment or relationship.

Danger, Warning, Caution

Read these instructions carefully and look at the equipment to become familiar with the device before trying to install, operate, or maintain it. The following special messages may appear throughout this manual to warn of potential hazard and to call attention to additional information which clarifies or simplifies a procedure.

Safety precaution is classified by danger, warning, caution and the meaning is as follows.



Danger

Not following the instruction may result in serious injury and even death



Warning

Not following the instruction may result in serious injury and even death



Caution

Not following the instruction may result in minor or moderate injury, or property damage

Dangerous procedures

In addition to other procedures described in this manual as dangerous, user personnel must adhere to the following:

- 1) Always work only on de-energized equipment. Always de-energize a contactor, and remove it from the equipment before performing any tests, maintenance or repair.
- 2) Always let an interlock device or safety mechanism perform its function without forcing or defeating the device.

2. Caution



Caution

- 1) Be sure to tighten the terminal screws to the torque specified in the instruction manual.
- 2) Do not install in areas subject to high temperature, high humidity, dust, corrosive gas, vibrations, and shocks. To do so may result in malfunction or fire.
- 3) To get Compact ACB tripped automatically, always clear the source of the malfunction before closing the Compact ACB again. Failure to do so may result in fire.
- 4) Terminal screws should be checked and tightened periodically. Failure to do so may result in fire.
- 5) Use the Compact ACB in 50/60Hz. Failure to do so may result in malfunction or fire.

3. Danger



Danger

Hazard of bodily injury or equipment damage

- 1) Only qualified electrical workers with training and experience on high voltage circuits should perform work described in this set of instructions. These workers must understand the hazards involved in working with or near high voltage equipment. Such work should be performed only after reading this complete set of instructions.
- 2) The successful operation of Compact ACB depends upon proper handling, installation, operation, and maintenance. Neglecting fundamental installation and maintenance requirements may lead to personal injury as well as damage to electrical equipment or other property.
- 3) Compact ACB have features designed to prevent unsafe operation, but it is not possible to eliminate every hazard with these features. Therefore, the person using this device is responsible for recognizing the potential hazards, for wearing protective safety equipment, and for taking adequate safety precautions.
- 4) Do not make any adjustment to the equipment or operate the system with safety features removed. Contact your local LSIS representative for additional instructions if the Compact ACB does not function as described in this manual.
- 5) Before performing visual inspections, tests, or maintenance on this device, disconnect all sources of electric power. Assume that all circuits are live until they have been completely de-energized, tested, grounded, and connected. Pay particular attention to the design of the power system. Consider all sources of power, including the possibility of back feeding.
- 6) Before replacing covers or closing doors, carefully inspect the bus work area for tools and objects left inside the equipment. Use care while removing or installing panels so that they do not extend into energized bus.
- 7) Before making any electrical connection, take every precaution to see that all connections are de-energized and grounded.
- 8) Introducing foreign objects into this equipment can cause a short circuit which can result in severe damage, personal injury, or death. Short circuits can release large amounts of energy due to a rapid expansion of super-heated, ionized gases. Products of this instantaneous expansion can quickly engulf and burn personnel before preventive action can be taken. The short circuit source can cause additional injuries by propelling personnel or objects several feet from the equipment. Some foreign objects that can cause short circuits are tools, test leads and instruments not designed for high voltage circuits, wire, and other conducting or semi conducting materials. Workers must also be careful to keep clothing and body parts out of the equipment. Failure to observe these precautions could result in severe personal injury, death, or equipment.

4. Warning



Warning

Receiving

A visual inspection - inside and out - should be performed immediately upon receipt of the Compact ACB and before removing it from the truck. Shipping papers should be checked to ensure all boxes or other accompanying pieces have been received. If any damage or shortages are evident, a claim should be filed at once with the carrier, and the nearest LSIS sales office. Claims for shortages or other errors must be made in writing to LSIS within 30 days after receipt of Compact ACB. Failure to do so constitutes unqualified acceptance and a waiver of all such claims by the purchaser.

Handling

Removable lifting plates are provided on the top of the Compact ACB structure for insertion of hooks to lift the complete structure. This is the only recommended method of moving the Compact ACB structure. Extreme care should be used not to damage or deform the unit if other moving methods are employed.

Storage

If it is necessary to store the equipment before installation, keep it in a clean, dry location with ample air circulation and heat to prevent condensation. Like all electrical apparatus, these units contain insulation that must be protected against dirt and moisture. Outdoor units may be stored outside only if roof caps are installed, space heaters energized and any openings are enclosed.

Lifting Instructions

- 1) Do not pass cables or ropes through support holes.
- 2) Always use load rated shackles or safety hooks in support holes.
- 3) Rig so that legs of sling are no less than 45 degrees from horizontal.

Moving

A crane or hoist can also be used to handle the breaker, if the lifting device is not available. If a forklift is utilized, the following precautions should be taken when moving circuit breakers:

- 1) Keep the breaker in an upright position only.
- 2) Make sure the load is properly balanced on the forks.
- 3) Place protective material between the breaker and the forklift to prevent bending or scratching.
- 4) Securely strap the breaker to the forklift to prevent shifting or tipping.
- 5) Excessive speeds and sudden starts, stops, and turns must be avoided when handling the breaker.
- 6) Lift the breaker only high enough to clear obstructions on the floor.
- 7) Take care to avoid collisions with structures, other equipment, or personnel when moving the breaker.
- 8) Never lift a breaker above an area where personnel is.

1. Normal / Special service condition

Normal service conditions

If under ordinary conditions the following normal working conditions are all satisfied, Compact ACB should be used under this condition unless otherwise specified.

- 1) Ambient temperature
A range of max. +40°C to min. -5°C is recommended. However, the average temperature of 24 hours does not exceed +35°C.
- 2) Altitude 2,000m or less.
- 3) Environmental conditions
The air must be clean, and the relative humidity does not exceed 85% at a max. of +40°C and 90% at 20°C. Do not use and store in presence of corrosive or ammonia gas.
(H₂S ≤ 0.01ppm, SO₂ ≤ 0.01ppm, NH₃ ≤ a few ppm)
- 4) Installation conditions
When installing Compact ACB, refer to catalogue or the installation instructions in the instruction manual.
- 5) Storage temperature
A range of max. +60°C to min. -20°C is recommended.
- 6) Replacement
Approx. 15 years (depends on number of breaking of over current or service condition). Please see maintenance and inspection for further detail.

Special service conditions

In the case of special service condition, modified air circuit breakers are available. Please specify when ordering. Service life may be shorter, it depends on service conditions.

- 1) Special environmental conditions
If it is used at high temperature and/or high humidity, the insulation durability and other electrical or mechanical features may deteriorate. Therefore, the breaker should be specially treated. Moisture fungus treatment with increased corrosion-resistance is recommended. When using products under this condition, please contact LS service team or nearest sales representatives.
- 2) Special ambient temperature
If the ambient temperature exceeds +40°C, reduce the continuous conducting current for a use referring to Table. A.
- 3) Special altitude
If it is used at the 2,000m or higher the heat radiation rate is reduced and the operating voltage, continuous current capacity and breaking capacity are decreased. Moreover the durability of the insulation is also decreased owing to the atmospheric pressure. Contact us for further detail.

Table A. The compensation of rated current according to ambient temperature

Switchgear composition (Maximum withstand temperature for the terminal 125°C)		3		2		1	
		Vertical		Horizontal			
Connection type		Vertical		Horizontal			
Busbar dimensions (mm)		2b. 50×10		2b. 50×10			
	IP41	35°C	3	1,330		1,190	
			2	1,400		1,240	
		45°C	3	1,500	1,270	1,310	1,120
			2	1,320	1,240	1,180	
		55°C	3	1,420	1,190	1,240	1,050
			2	1,240	1,160	1,090	
	IP54	35°C	3	1,230		1,090	
			2	1,310		1,160	
		45°C	3	1,390	1,150	1,300	1,020
			2	1,240	1,080	1,100	960
		55°C	3	1,310	1,080	1,220	1,020
			2	1,160	1,140	1,020	

2. Altitude and insulation clearance

Altitude

Compact ACB is designed for operation at altitudes under 2000m. At altitudes higher than 2000m, change the ratings upon a service condition.

Item	Altitude (m)	2000	3000	4000	5000
Withstand Voltage (V)		3500	3150	2500	2100
Average insulating voltage (V)		1000	900	700	600
Max. using voltage (V)		690	590	520	460
Current compensation constant		1×In	0.99×In	0.96×In	0.94×In

Insulation clearance

When drawing the electric power supply panel, please keep the distance of Insulation clearance between Compact ACB and panel as listed in table.

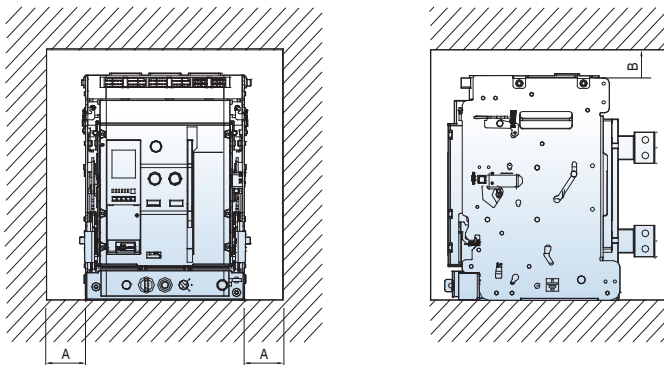

(Unit : mm)

Type	A	B
Fixed	50	150
Fixed (When installing Arc Screen)	5	50
Draw out	5	50

Minimum insulation clearance

The dimension of all charging parts should be over the minimum insulation clearance.

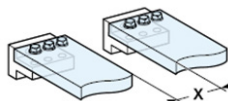

Insulating voltage (Ui)	Min. insulation clearance (X min)
600V	8 mm
1000V	14 mm

1. Internal structure and components

Internal configuration

- 1 Control terminal block
- 2 Control terminal
- 3 Auxiliary switch
- 4 Closing, Tripping, UVT coil
- 5 Trip relay
- 6 Front cover
- 7 Mechanism
- 8 Charging handle
- 9 Tripping spring
- 10 Closing spring
- 11 Draw-out device
- 12 Arc extinguishing part
- 13 Moving contact
- 14 Fixed contact
- 15 Current carrying part on line
- 16 Cradle finger
- 17 Cradle
- 18 Current carrying part in circuit breaker
- 19 Current transformer
- 20 Current carrying part on load

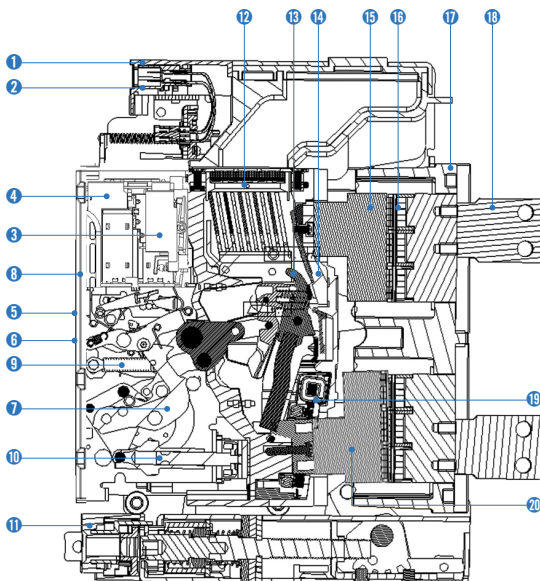

Components

- 1 Control terminal block
- 2 Auxiliary switch
- 3 Arc chute
- 4 Tripping coil
- 5 UVT coil
- 6 Mechanism
- 7 Main body
- 8 Counter
- 9 Magnetic trip device
- 10 Trip relay
- 11 Front cover
- 12 Motor assembly
- 13 Button ON
- 14 Button OFF
- 15 Closing coil

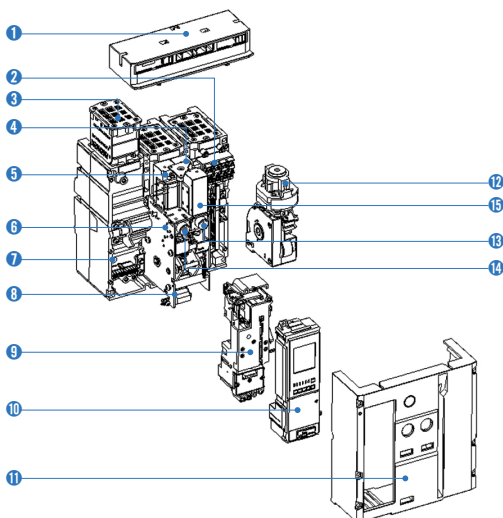

1. Internal structure and components

External configuration

• Fixed type

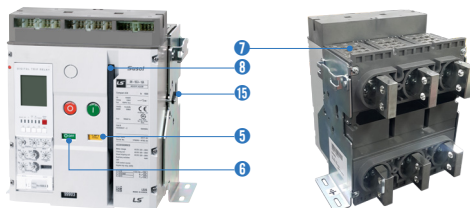

• Draw-out Type



- 1 ON button
- 2 OFF button
- 3 Series name
- 4 Rated name plate
- 5 Charge/Discharge indicator
- 6 ON/OFF indicator
- 7 Arc box
- 8 Charge handle
- 9 Drawout handle
- 10 Handle storage space
- 11 Pad lock button
- 12 Position indicator
- 13 Arc cover
- 14 Digital trip relay
- 15 Mechanical interlock

Terminal Configuration

There are many possible terminal configurations when connecting bus-bar of distribution panel, vertical, horizontal, plane type, etc

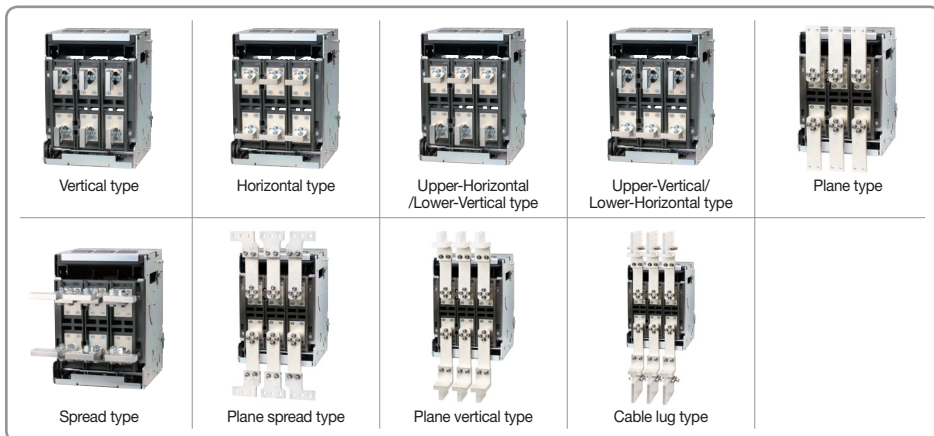

2. Basic function and breaking operation

Compact ACB prevents a fire, a property damage, the breakage of an electrical equipment on load side by protecting a circuit from the fault currents.

1. Circuit Closing

The closing operation of mechanism applies the current to the load. When energized, some loads makes inrush current much greater than rated current (I_n) (e.g. Motor takes in 7~8times of I_n for a few seconds).

To prevent these over current which causes the dangerous phenomena for contacts (Erosion by arcs), closing operation should be prompt. If a circuit breaker is in accordance with all standard cases, it should be able to endure 15~20 times of the rated current and be opened promptly for the faults occurred during closing operation or after it has closed.

2. Current Conducting

A circuit breaker must not be exceeding an acceptable temperature rise under normal current conducting and there must be safe current conducting within specified breaking time under over current.

Furthermore, if a circuit breaker is of the discriminated type, it must has the structure which can withstand the high electro-dynamics to accept the short-circuit current while a circuit breaker in downstream is operating to break it.

3. Circuit Opening, Current Breaking

1) Current can be broken manually or remotely by voluntary operation on mechanism.

2) A circuit breaker opens a circuit automatically under condition of current which may has any values at this time by an auxiliary trip unit (Under voltage, Ground fault, etc.)

3) A circuit breaker opens a circuit automatically against the over current because it is operated by OCR (the trip unit) even if it is in the closed position.

4. Isolation

When a circuit breaker is open, a certain isolation level is required between charging and non-charging parts. The Isolation Level is decided by following tests.

1) A maximum leakage current test under rated using voltage (Max. U_e)

2) An impulse voltage

There are following breaking principles regarding over current.

1. Instantaneous trip

When short-circuit current flows in, Compact ACB trips instantly to minimize side effect due to the accident on load side. It is called instantaneous trip.

2. Time delay breaking

When abnormal current flows in such as inrush current of transformer or condenser, and starting current of motor, Compact ACB keeps the conducting condition for a regular time and break the current if it is continuously remained. In case of short-circuit, Compact ACB minimizes the damage from accident by keeping the circuit for the time previously set concerning the operating time of branch breakers under selective discrimination.

However, it breaks the circuit after the delayed time in case abnormal current continuously flows in due to the breaking failure of branch breakers. It is called as Time delayed breaking.

3. Overload trip

If the current which exceeds the rated current flows in continuously, the cable is getting hotter and it causes the big fire. Therefore, Compact ACB breaks the current before the temperature of cable reaches the dangerous level. It is called overload trip.

4. Ground-fault trip

Ground fault defines as current flows into the ground from circuit or charging part of load due to breakdown. If ground fault current flows, it is inducted to other cables nearby owing to electronic induction, voltage level is risen and it finally cause severe effects or damage on other device.

Furthermore, in case personnel hands are touched, it may result in electrical shock. Ground fault breaking is to prevent any possible accident occurred from ground fault.

1. Types of Susol Compact ACB

Compact ACB

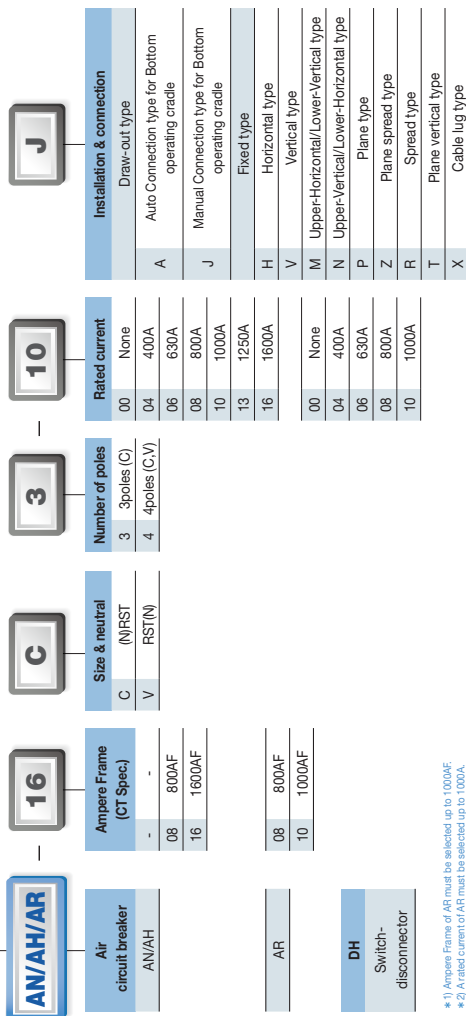
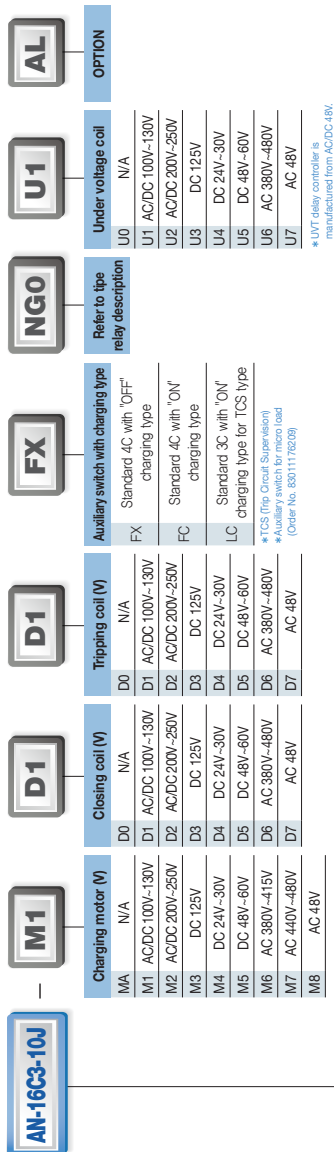

*1) Ampere Frame of AR must be selected up to 1000AF.
 *2) Rated current of AR must be selected up to 1000A.

1. Types of Susol Compact ACB

Options

Code	Description	Option description
AL	AL1 + MRB	
A1	AL1 + MRB + RES(AC110-130V) * AC only	
A2	AL1 + AL2 + MRB	
A3	AL1 + MRB + RES(DC110-125V) * DC only	
A4	AL1 + MRB + RES(AC200-250V) * AC only	
A5	AL1 + MRB + Auto reset	
A6	AL1 + AL2 + MRB + Auto reset	
A7	AL1 + MRB + RES(DC110-125V) + Auto reset * DC only	
A8	AL1 + MRB + RES(AC200-250V) + Auto reset * AC only	
A9	AL1 + MRB + RES(AC110-130V) + Auto reset * AC only	
C	C	COUNTER
B	B	On/Off Button lock
K	K1	Key lock
K2	K2	Key interlock set
R	RCS	Ready to close switch
H1	SHT2 <small>(Note)</small>	AC/DC 100V ~ 130V, double shunt coil
H2		AC/DC 200V ~ 250V, double shunt coil
H3		DC 125V, double shunt coil
H4		DC 24V ~ 30V, double shunt coil
H5		DC 48V ~ 60V, double shunt coil
H6		AC 380V ~ 480V, double shunt coil
H7		AC 48V, double shunt coil

*Note) UVT & SHT2 can be not applicable together.

2. Types of OCR/
Cradle series

OCR

0	Without trip relay
N	
OCR TYPE	
N	Normal

A	
OCR TYPE	
A	Ammeter

P	
OCR TYPE	
P	Power meter

S	
OCR TYPE	
S	Supreme meter

0	Without trip relay
G	
Communication & ground fault protection	
G	Ground fault (Residual earth fault protection), No Communication

G	
Communication & ground fault protection	
G	Ground fault (Residual earth fault protection), No Communication
Z	Ground fault (External CT, Earth leakage below 30A)
E	Ground fault (External CT, Earth leakage over 30A)
C	Comm. + Ground fault (Residual earth fault protection)
K	Comm. + Ground fault (External CT, Earth leakage below 30A)
X	Comm. + Ground fault (External CT, Earth leakage over 30A)

* Communication work under external power (AC0, AX0, ACS, AXS)
 * L.S.I,G alarm contacts works under external power (LED indicator work without external power)
 * No output contact AG0, AG5, AEO, AES
 * Z, K: External CT - LS ZCT applied (fault current 0.5-30A, 1600AF)
 * E, X: External CT - Private ZCT applied (fault current >30A)

G	
Communication & ground fault protection	
C	Comm. + Ground fault (Residual earth fault protection)
K	Comm. + Ground fault (External CT, Earth leakage below 30A)
X	Comm. + Ground fault (External CT, Earth leakage over 30A)

* Communication functions are Normal. (Function unavailable without control power supply)
 * Applicable to generator protection purpose
 * Voltage module of P type or more is basic.
 * K: External CT - LS ZCT applied (fault current 0.5-30A, 1600AF)
 * X: External CT - Private ZCT applied (fault current >30A)

G	
Communication & ground fault protection	
C	Comm. + Ground fault (Residual earth fault protection)
K	Comm. + Ground fault (External CT, Earth leakage below 30A)
X	Comm. + Ground fault (External CT, Earth leakage over 30A)

* Communication functions are Normal. (Function unavailable without control power supply)
 * Applicable to generator protection purpose
 * Voltage module of P type or more is basic.
 * K: External CT - LS ZCT applied (fault current 0.5-30A, 1600AF)
 * X: External CT - Private ZCT applied (fault current >30A)

0	Without trip relay
0	
Control voltage & frequency	
0	None, 60Hz
5	None, 50Hz

0	
Control voltage & frequency	
0	None, 60Hz
1	AC/DC 110V-250V, 60Hz
2	DC 24V-60V, 60Hz
5	None, 50Hz
6	AC/DC 110V-250V, 50Hz
7	DC 24V-60V, 50Hz

0	
Control voltage & frequency	
1	AC/DC 110V-250V, 60Hz
2	DC 24V-60V, 60Hz
6	AC/DC 110V-250V, 50Hz
7	DC 24V-60V, 50Hz

0	
Control voltage & frequency	
1	AC/DC 110V-250V, 60Hz
2	DC 24V-60V, 60Hz
6	AC/DC 110V-250V, 50Hz
7	DC 24V-60V, 50Hz

Cradle

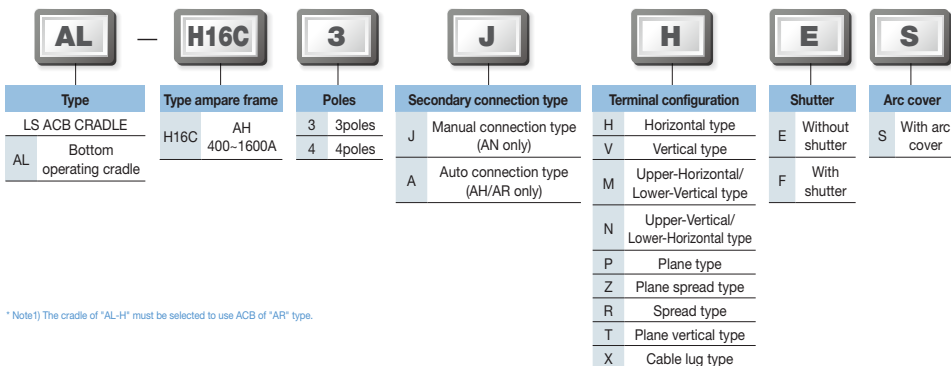

3. Ratings

Susol Compact ACB

Common characteristics								
Number of poles	(P)					3/4		
Frequency	(Hz)					50/60		
Rated operational voltage	(V, Ue)					690		
Rated insulation voltage	(V, Ui)					1000		
Rated impulse withstand voltage	(kV, Uimp)					12		
Circuit breaker as per IEC60947-2								
Type			AN/AH/AR-C					
Description			AN-08C	AN-16C	AH-08C	AH-16C	AR-08C	AR-10C
Ampere Frame	(AF)		800	1600	800	1600	800	1000
Rated current (In Max.) at 40°C	(A)		400	-	400	-	400	-
	(A)		630	-	630	-	630	-
	(A)		800	800	800	800	800	800
	(A)		-	1000	-	1000	-	1000
	(A)		-	1250	-	1250	-	-
	(A)		-	1600	-	1600	-	-
Rated current of neutral pole	(A)		100%					
Rated breaking capacity (Icu)	(kA)	IEC60947-2	AC 690V/600V/550V	42		50		-
			AC 500V/480V/460V	42		50		130 ¹⁾
			AC 415V/380V/220V	50		60		150
Rated service breaking capacity (Ics)	(kA, % x Icu)		100%					
Rated making capacity (Icm)	(kA)		88.2		105		17 ²⁾	
Rated Short-time capacity (Icw)	(kA)	1sec/3sec	42/25		50/30		10 ³⁾	
Operating time (t)	(ms)	Total breaking time					40	
		Closing time					80	
Common mechanical and electrical life cycle								
Life Cycle	(time)	Mechanical					12,500	5,000
		Electrical					6,000	3,000
Common Dimension and Weight								
Weight	(kg)	Drawable type (3P/4P)					16/19.5	
		Fixed type (3P/4P)					16/19.5	
		Cradle (3P/4P)					22/26	
Dimension	(mm)	Drawable type	3P	W : 256 D : 269.5 ⁴⁾ H : 364.3				
			4P	W : 326 D : 269.5 ⁴⁾ H : 364.3				
		Fixed type	3P	W : 272.4 D : 198.3 ⁴⁾ H : 322				
			4P	W : 342.4 D : 198.3 ⁴⁾ H : 322				

1) 130kA/460V, 100kA/500V

2) at 500V

3) 0.5sec

4) Exclude terminal length

1. Weight & dimension

1. Weight

Type	AN type	AH type	AR type
Fixed type (3P,4P)	16/19.5		16/19.5
Draw-out type (3P,4P)	16/19.5		16/19.5
Cradle (3P/4P)	22/26		

2. Dimension

1) Fixed type

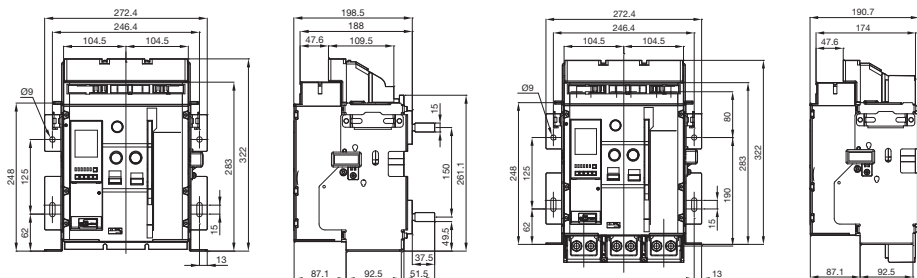

2) Mounting (Fixed type)

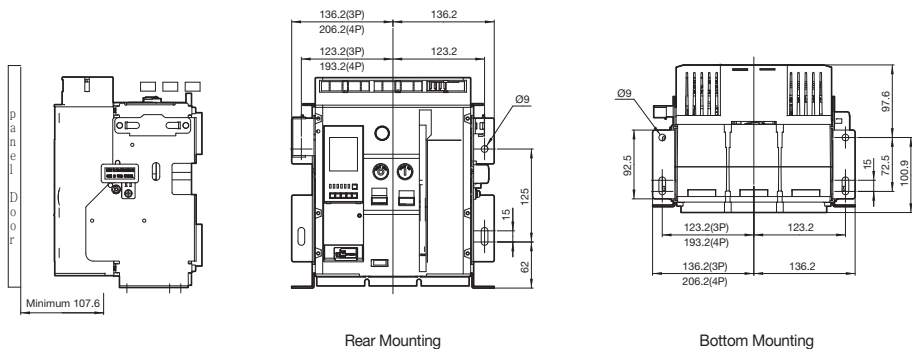

2. Dimension

3) Connections (Fixed Type)

a. 3P Horizontal type (H)

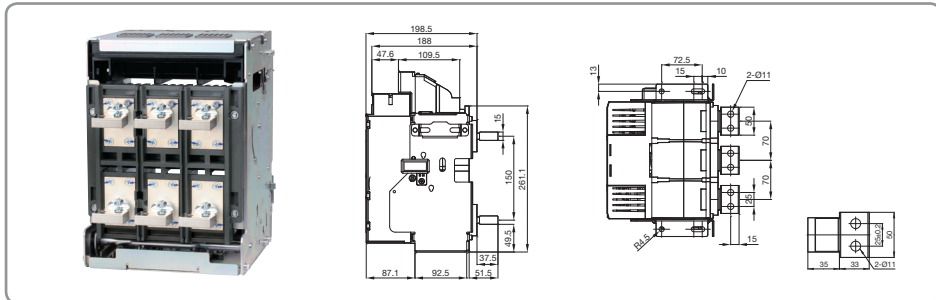

b. 3P Vertical type (V)

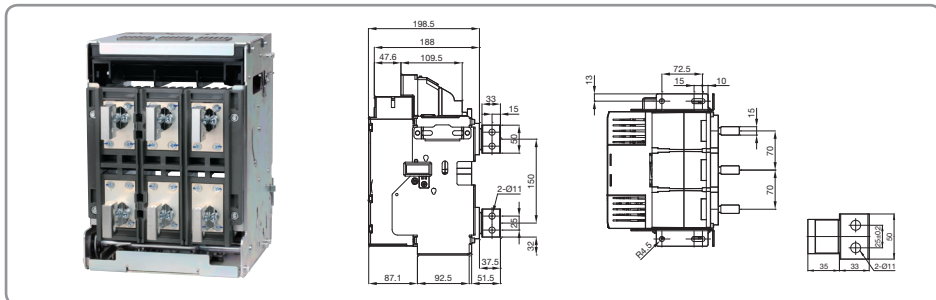

c. 3P Upper-Horizontal/Lower-Vertical type (M)

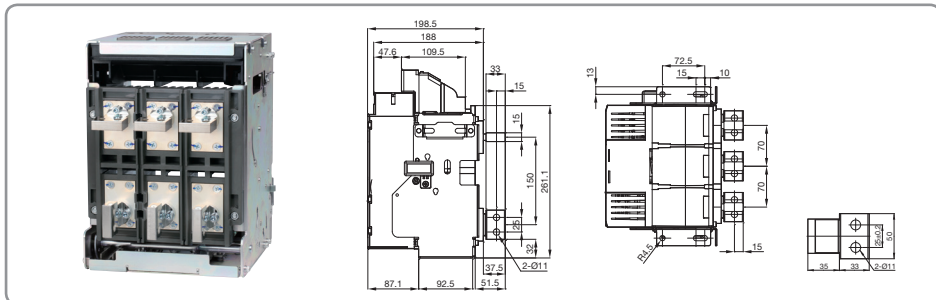

2. Dimension

d. 3P Upper-Vertical/Lower-Horizontal type (N)

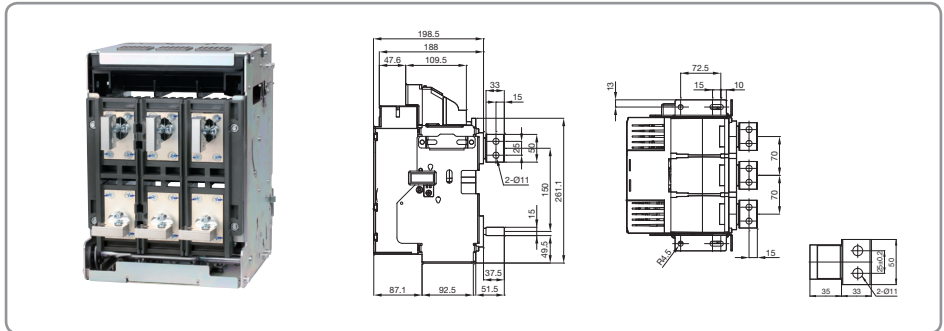

e. 3P Plane type (P)

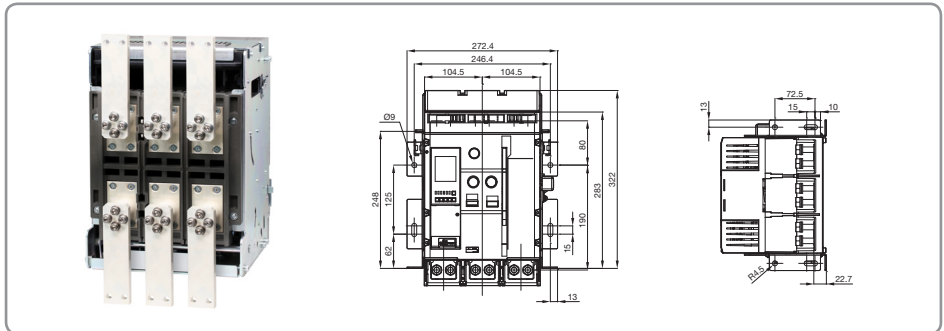

f. 3P Spread type (R)

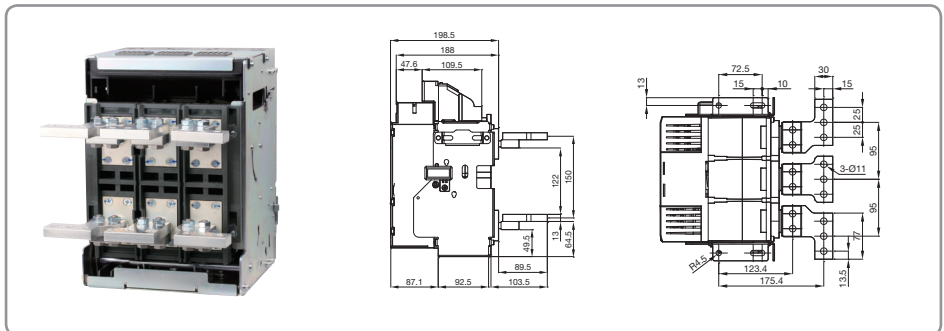

2. Dimension

j. 4P Horizontal type (H)

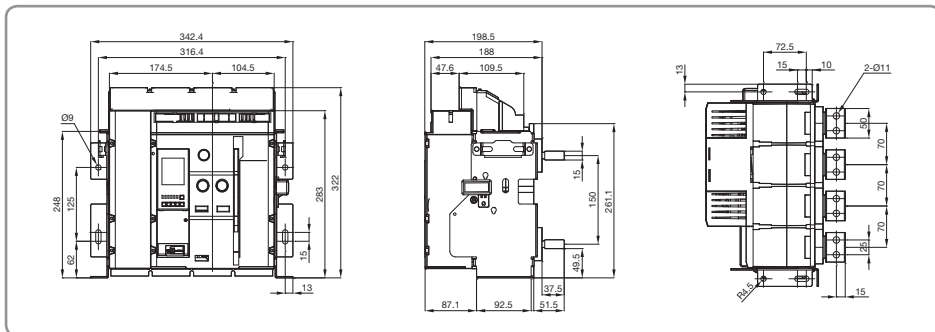

K. 4P Vertical type (V)

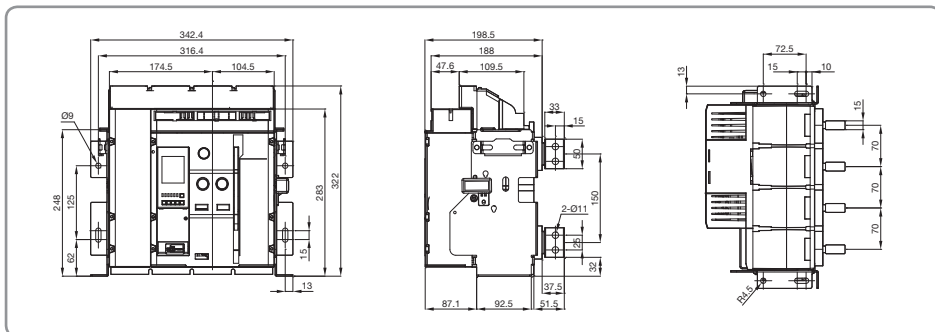

I. 4P Upper-Horizontal/Lower-Vertical type (M)

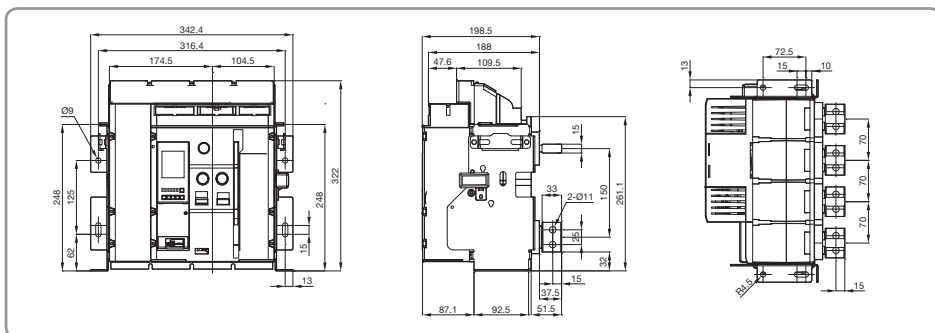

2. Dimension

m. 4P Upper-Vertical/Lower-Horizontal type (N)

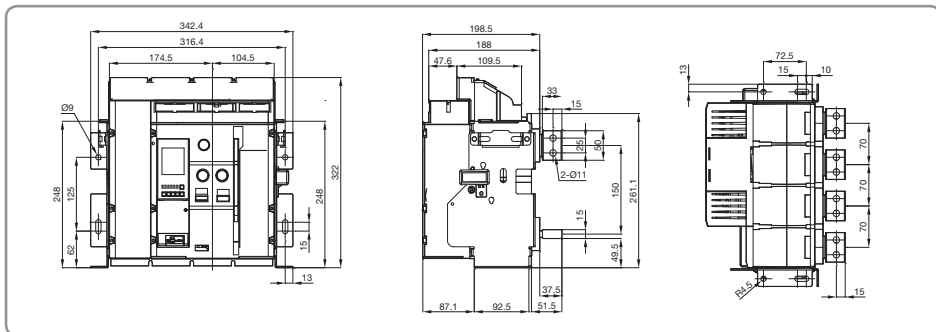

n. 4P Plane type (P)

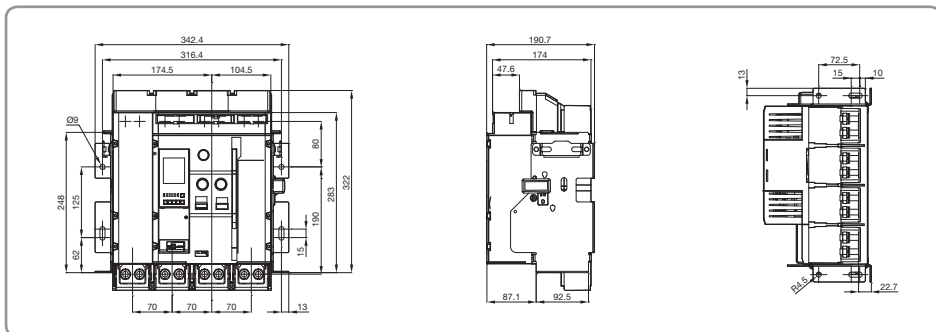

o. 4P Spread type (R)

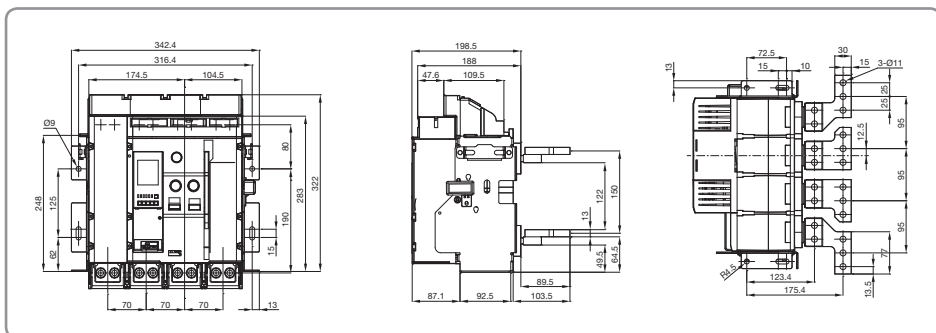

2. Dimension

p. 4P Plane spread type (Z)

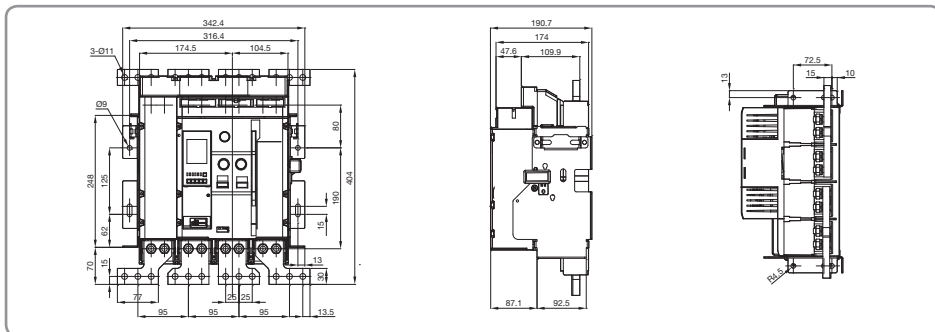

q. 4P Plane vertical type (T)

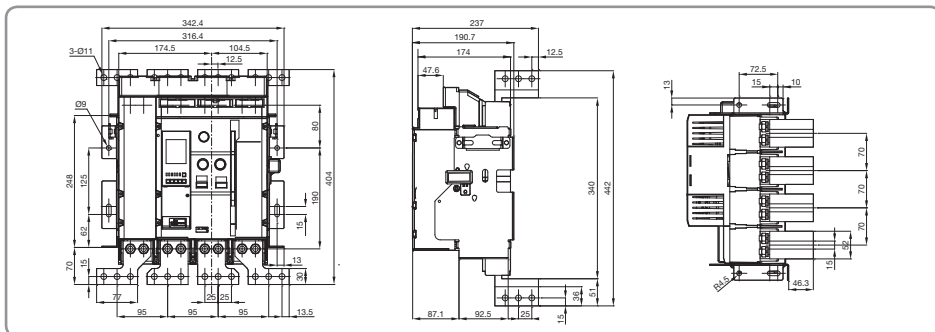

r. 4P Cable Lug type (X)

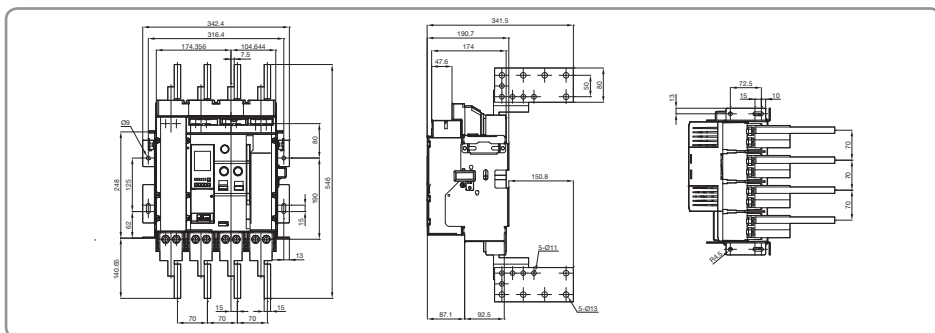

2. Dimension

4) Draw-out type

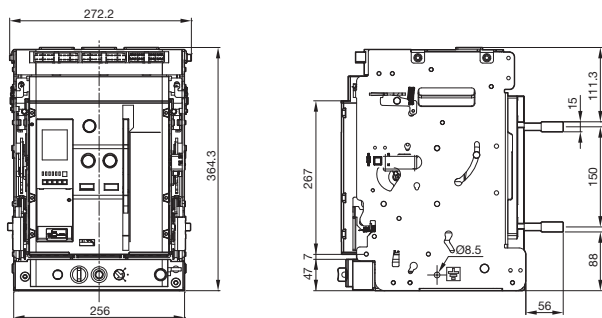

5) Mounting (Draw-out type)

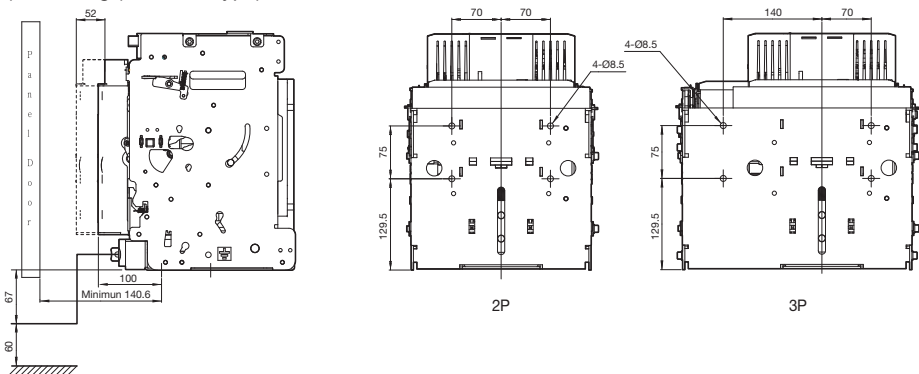

6) Connections (Draw-out type)

a. 3P Horizontal type (H)

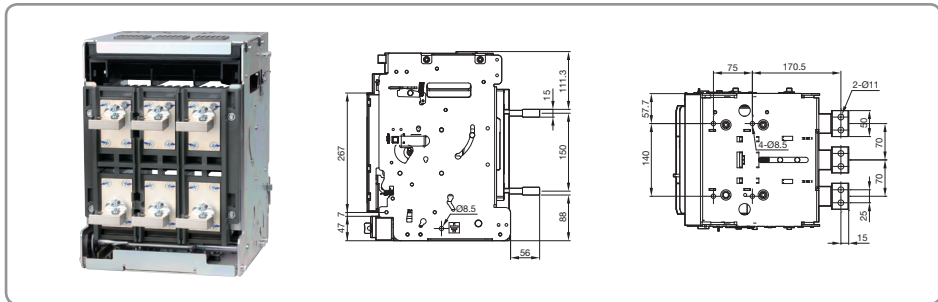

2. Dimension

e. 3P Plane type (P)

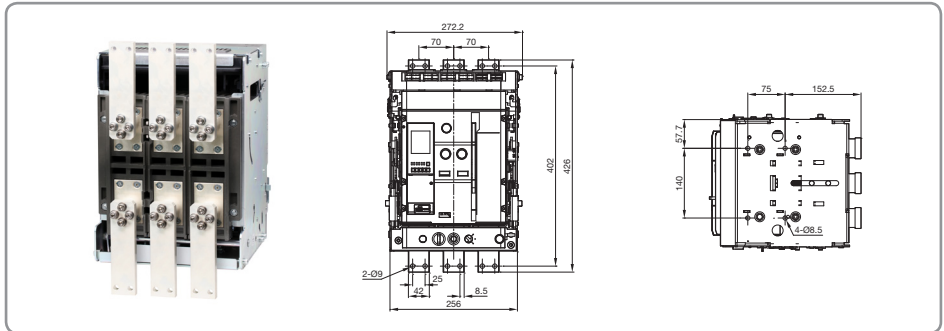

f. 3P Spread type (R)

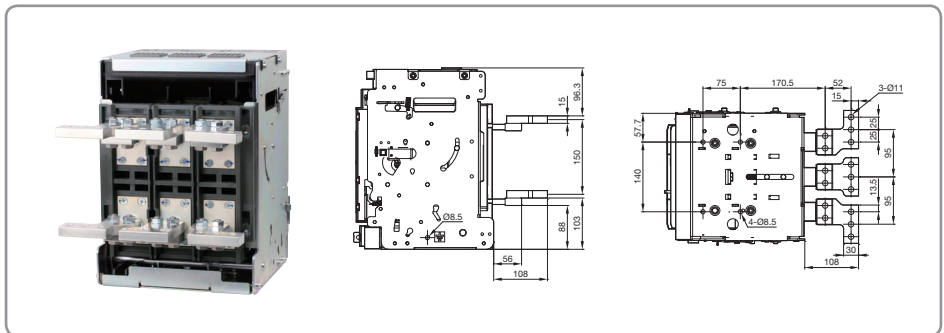

g. 3P Plane spread type (Z)

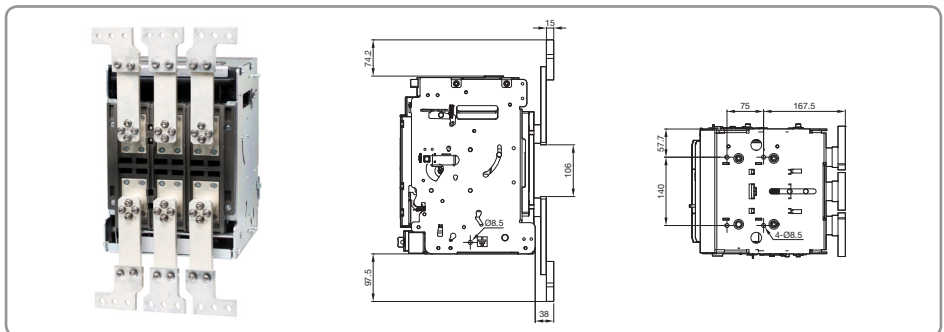

2. Dimension

K. 4P Vertical type (V)

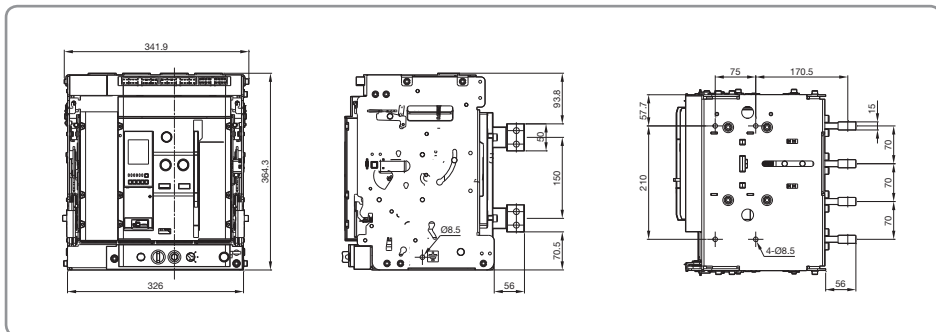

I. 4P Upper-Horizontal/Lower-Vertical type (M)

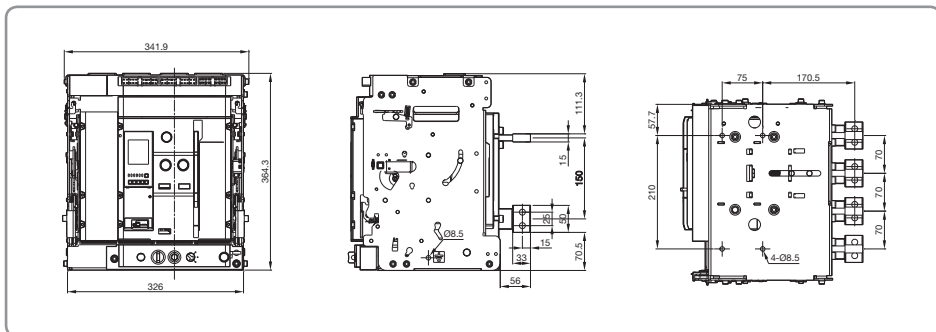

m. 4P Upper-Vertical/Lower-Horizontal type (N)

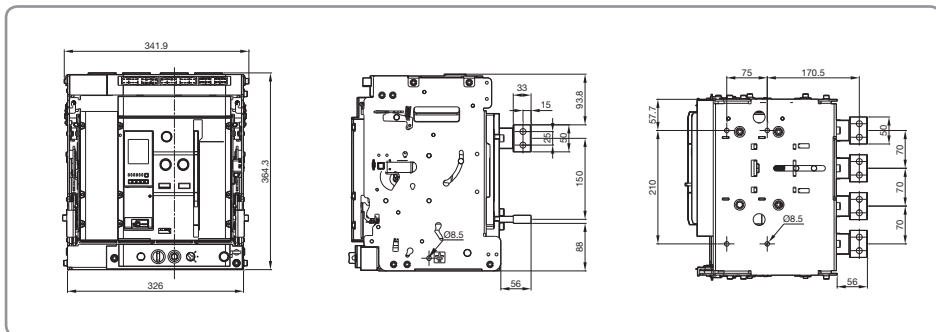

2. Dimension

n. 4P Plane type (P)

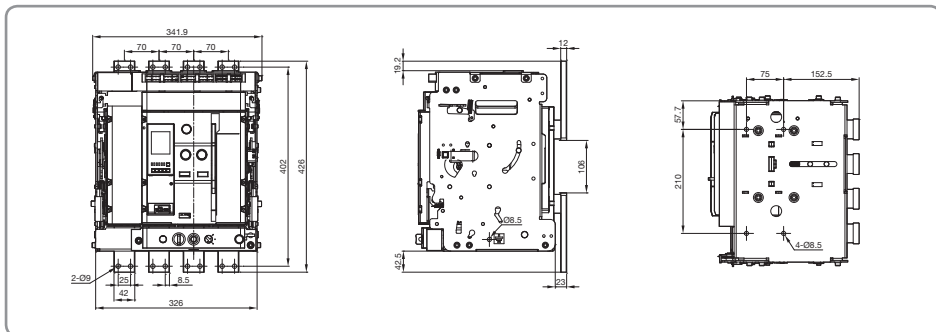

o. 4P Spread type (R)

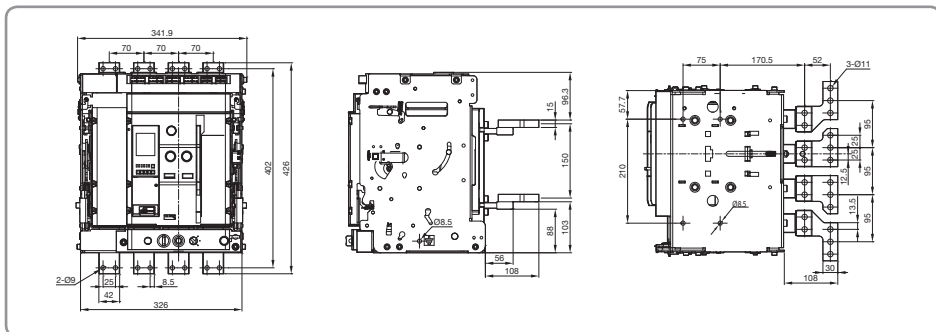

p. 4P Plane spread type (Z)

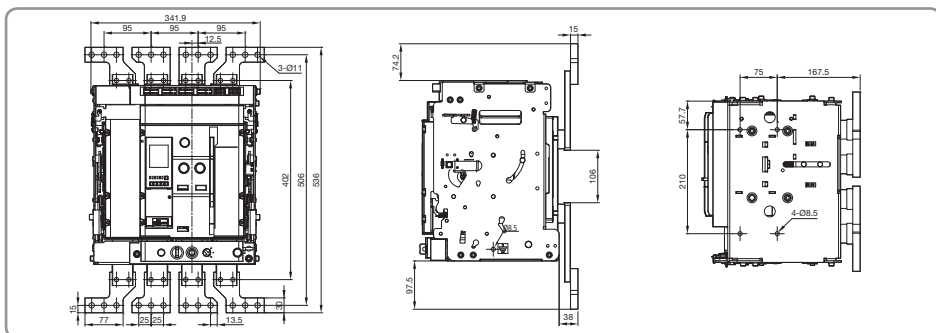

2. Dimension

q. 4P Plane vertical type (T)

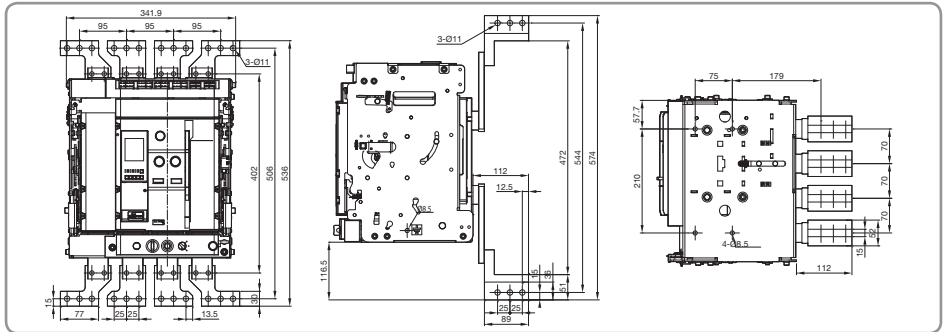

r. 4P Cable Lug type (X)

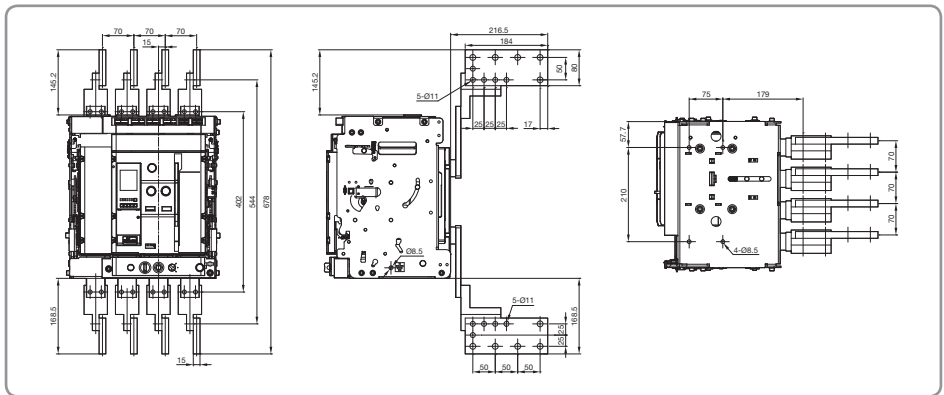

1. Receiving

Receiving

A visual inspection - inside and out - should be performed immediately upon receipt of the Compact ACB and before removing it from the truck. Shipping papers should be checked to ensure all boxes or other accompanying pieces have been received. If any damage or shortages are evident, a claim should be filed at once with the carrier, and the nearest LSIS sales office. Claims for shortages or other errors must be made in writing to LSIS within 30 days after receipt of Compact ACB. Failure to do so constitutes unqualified acceptance and a waiver of all such claims by the purchaser.

2. Unpacking

Unpacking

- 1) Before unpacking the breaker, check that all boxes and packing are in good condition.
- 2) While unpacking, check the breaker is in good condition.
- 3) Check that the information given on the rating /accessory nameplates corresponds to the purchase order.
- 4) Care about the unpacking to avoid damaging the products. Unpacking them attentively to avoid dropping the products from carrying components and pallets.
- 5) Install the products to the final installation place after unpacking as soon as possible. If you cannot install the products immediately, you had better not unpacking them. Keep the products indoor around 15°C and under 50% of humidity. Standard packing condition for domestic portage is not suited to outdoor storage. If you cannot keep the maintenance above, you should inspect a degree of the damages before you install the products. Unsuitable keeping does not guarantee good qualities of the products and could occur additional danger of an accident.

* Do not load Susol/Metasol ACBs on the Compact ACB

Unpacking

- 1) After unpacking the Cradle, As shown in Figure.1, make sure the bottom of the cradle faces the ground.
- 2) Hold the bottom of the cradle and remove it from the box.
- 3) When removing the cradle from the box, do not hold the control terminal block. If the product is damaged, it is the responsibility of the customer.



Fig 1. How to unpack the Cradle

3. Check point and caution

Please read the following check points and caution carefully as they imply the critical contents which should be confirmed before performing the unpacking, inspection, or installation, etc.

Check points upon receiving

- 1) A visual inspection - inside and out - should be performed immediately upon receipt of the Compact ACB and before removing it from the truck. If any damage or shortages are evident, a claim should be filed at once with the carrier to the nearest LSIS sales office.
- 2) Unpacking them attentively to avoid dropping the products from carrying components and pallets.
- 3) Install the products to the final installation place after unpacking as soon as possible. If you cannot install the products immediately, you had better not unpacking them. Keep the products indoor around 15°C and under 50% of humidity. Standard packing condition for domestic portage is not suited to outdoor storage. If you cannot keep the maintenance above, you should inspect a degree of the damages before you install the products. Unsuitable keeping does not guarantee good qualities of the products and could occur additional danger of an accident.

Caution for installation inspection

- 1) Confirm all power sources are completely de-energized first.
- 2) Disconnect all electrical switches which may operate during inspection.
- 3) Disconnect all plugs connected to operating part of product (Shunt coil, OCR, etc.)
- 4) In case of draw-out type, pull out the product until guideline comes to TEST position from cradle. (Basic inspection is available under TEST position.)
- 5) In case of detailed inspection, remove the product form cradle securely and put it to the even stand.
- 6) Inspect the product.

1. Handling

This breaker and cradle are designed to move easily by overhead lifting devices such as hoisters. You can use lifting hooks which is optional to move them without difficulty. All the carrying devices should be suited to the product's permissible weight which is presented in Table.5-1.

Precaution of Handling

- 1) To lift the breaker(Fixed type), use the lifting hooks on the sides of the breaker, and lift with rope or something similar.
- 2) When placing the breaker on the ground, be careful not to drop or to impact the breaker.
- 3) When the Draw-out breaker is lifted with the cradle, lift it in the connected position.
- 4) Do not slide the breaker when handling.

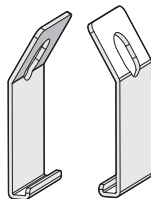

Fig 1. Handling method of Fixed type



Fig 2. Handling method of Draw-out type

2. Storage

Precaution of Storage

When storing a circuit breaker for a long term,

- 1) Keep the breaker at OFF position with the charging spring discharged.
- 2) Store the Draw-out type breaker on the plat place after the TEST position inserted.

Storage method

- 1) Store the breaker in a dust free and dry environment.
- 2) Keep the breaker in OFF position with the charging spring discharged.
- 3) Cover the breaker with a vinyl sheet or a similar cover. When putting the breaker into service after long term storage, it is unnecessary to lubricate the parts of the breakers.
- 4) keep the breaker indoor as it was packaged around 15°C and under 50% of humidity.
- 5) Standard packing condition for domestic portage is not suited to outdoor storage. If you cannot keep the maintenance above, you should inspect a degree of the damages before you install the products.
- 6) Unsuitable keeping does not guarantee good qualities of the products and could occur additional danger of an accident.

Compact ACB
OFF and discharged

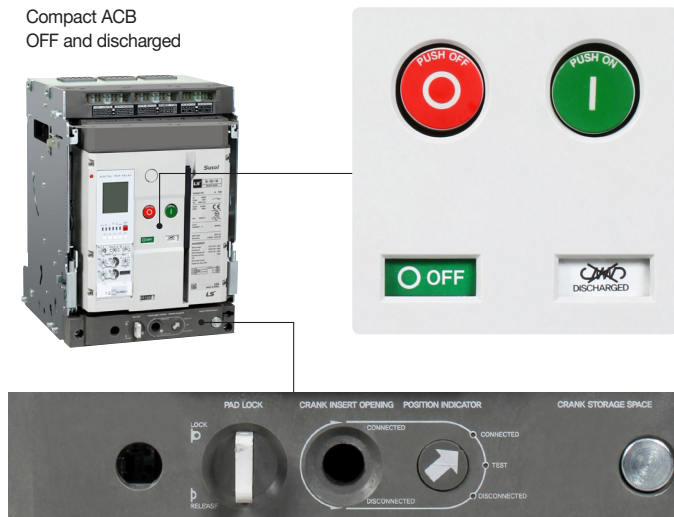

1. Fixed type

Installation of fixed type

Securely install the left and right mounting frames with M12 bolts (3P: 4ea, 4P: 6ea)

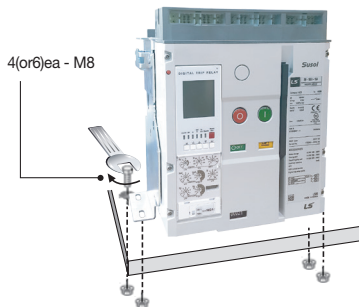

<Torque>

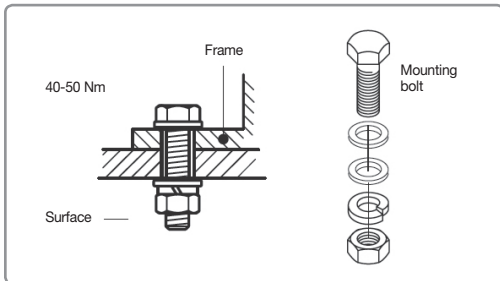

2. Draw-out type

Installation of draw-out type

Install Draw-out type according to the instruction given below.

- 1) Securely install the cradle at the bottom with M8 bolts (4ea).
- 2) Pull the extension rails of cradle forward.
- 3) Remove the MI protective cover on the right side of the main body.
- 4) Put the breaker on the rail as shown in picture by using lifting device.
- 5) Please check if the circuit breaker fits well to the cradle.
- 6) Slowly push the circuit breaker by moving the rail handle.

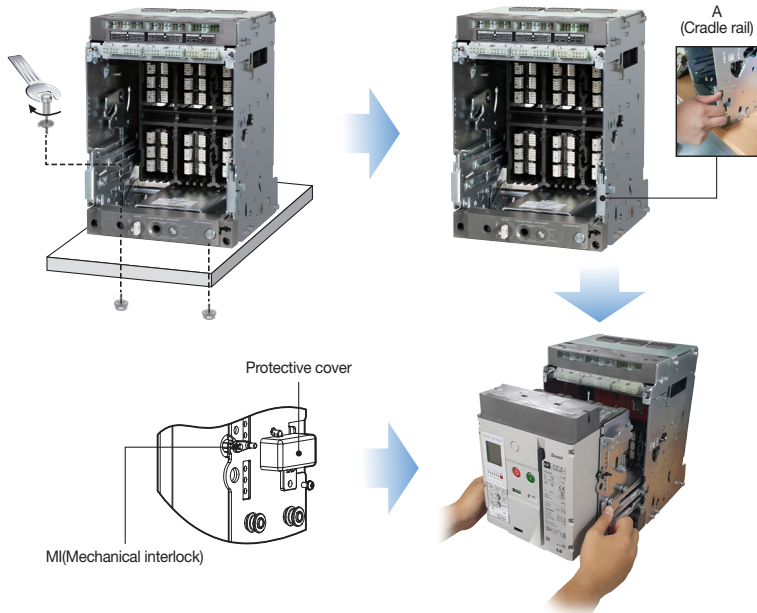

3. Precaution and installation of insulation barrier

Precaution

- 1) Do not lay down a breaker on the side or stand with the side of it.
- 2) Install a circuit breaker on perfect even ground. (Within 2mm of the level difference)
- 3) Do not install a circuit breaker with same direction of a rail when you use an angle.
- 4) Install a circuit breaker at a right angle to the direction of a rail to decentralize weight of the circuit breaker.



Insulation barrier

Insulation barrier can be assemble after installed Compact ACB for safety. (Options)

- 1) Insert the insulation barrier between pole and pole at back of Compact ACB. (1 → 2)

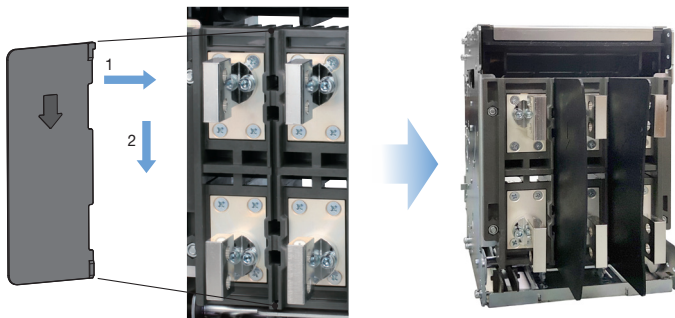

4. BUS-BAR Connection

Cable connection

Make sure that no excessive mechanical force put on the rear terminals for cable connection. Extension terminal is fixed such as B, C and cable is to fixed to the frame such as E.

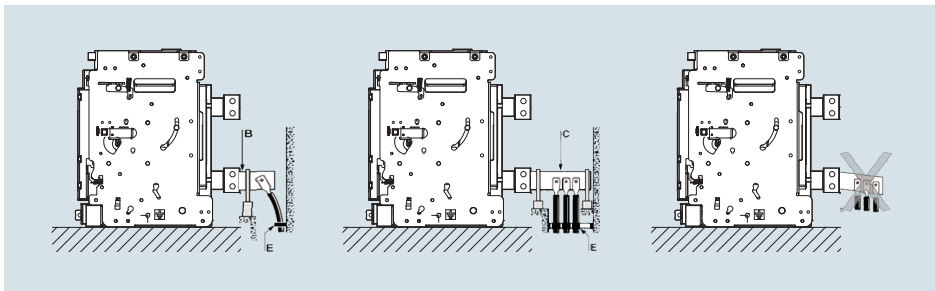

Bus-bar connection

For bus-bar connection, connect access parts with a provided torque and fix with parallel installing the support not to apply terminal weight to circuit breaker. In order to prevent the spread safety or secondary accidents, secure maximum safe distance A (The maximum safety distance of Compact ACB is 250mm) from the access area to withstand the electrical force during the short circuit faults. (Support strength: base of Insulator, bending load 720kg or more, tensile strength 3000kg or more)

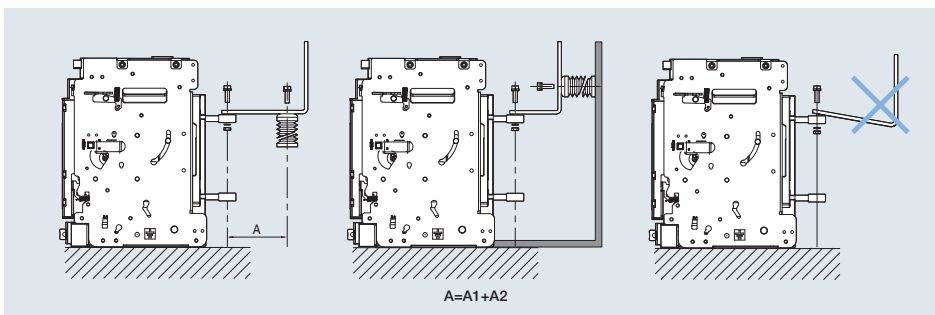

* Warranty can not be applied to product damage due to arbitrary alterations.

1. Manual operation



Caution

Before opening or closing the breaker equipped with an under voltage tripping device, control voltage should be applied

Manual charging

- 1) Charge the handle 7~ 8 times with full strokes.
- 2) When the closing spring is completely charged, the charging indicator shows "CHARGED".

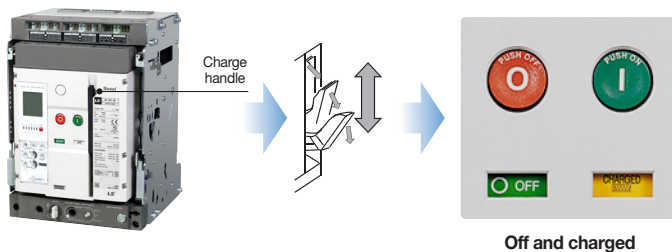

Off and charged

Manual closing

- 1) Push ON button.
- 2) The breaker will be closed.
- 3) The ON/OFF indicator shows "ON" and the charging indicator shows "DISCHARGED".

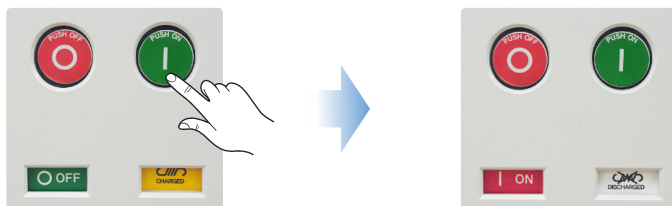

Manual tripping

- 1) Push the OFF button and breaker will be tripped.
- 2) The ON/OFF indicator shows "OFF".

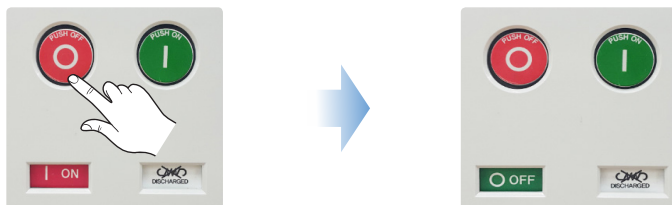

2. Electrical operation

Electrical operation

Closing operation is done by charging the closing spring from remote control. If pushing trip button, closing spring is automatically charged by a geared motor and a circuit breaker is closed by closing button.

Electrical closing

Remote closing can be made by energizing the closing coil (CC). Apply the rated voltage to the control terminals A1 and A2 and close the breaker.

Electrical trip

- 1) Remote opening can be made by energizing the shunt trip device or under voltage trip device.
- 2) In the case of SHT, apply the rated voltage to the terminal C1 and C2.
- 3) In the case of UVT, remote opening is also possible by applying a short - circuit across terminals D1 and D2 of the UVT controller.



3. Draw-in operation

Draw-in operation procedure

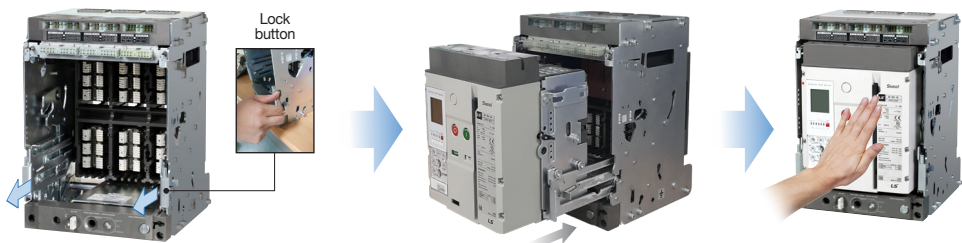

1) Pull the extension rails of cradle forward

2) Put the breaker on the rail by using lifting device. Please check if the circuit breaker fits well to the cradle

3) Slowly push the circuit breaker by moving the rail handle until it stops.

- 4) Keep pushing the OFF button when the circuit breaker in a trip condition, and insert a handle to the body of the circuit breaker.
- 5) Check the Draw-out handle properly inserted and then push the lock plate and turn the Draw-out handle clockwise in order to insert the breaker.
- 6) When the breaker reaches the TEST position, the lock plate automatically projects and the Draw-out handle is locked.
- 7) Push in the lock plate and turn the Draw-out handle again clockwise until the lock plate projects, the inserting operation is finished. At this time, the Draw-out position indicator shows CONNECTED position.

3. Draw-in operation

Disconnected



Lock

2 Release

Test

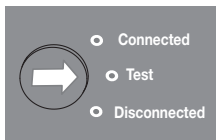

Release

Lock

4 Release

Connected



Release

Lock

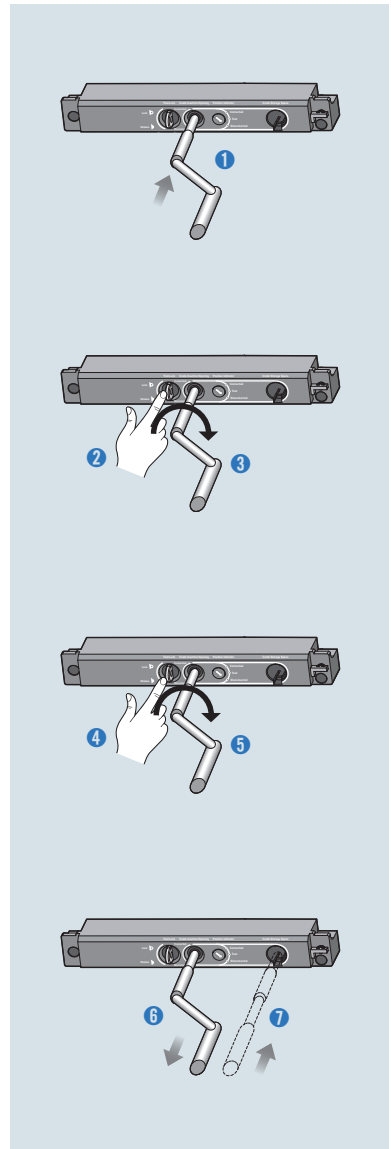

4. Draw-out operation



Caution

- 1) Please stop handle operation when draw in/out locking device protrudes.
- 2) Draw in or out by moving handle right or left side when draw in/out locking device can not be inserted.

Draw-out operation procedure

- 1) Pushing the OFF button and the circuit breaker in a trip condition, and insert a handle to the body of the circuit breaker.
- 2) Check the Draw-out handle properly inserted and then push the lock plate and turn the Draw-out handle counterclockwise in order to insert the breaker.
- 3) When the breaker reaches the TEST position, the lock plate automatically projects and the Draw-out handle is locked.
- 4) Push in the lock plate and turn the Draw-out handle again counterclockwise until the lock plate projects, At this time, the Draw-out operation is finished with indicator which shows DISCONNECTED position.

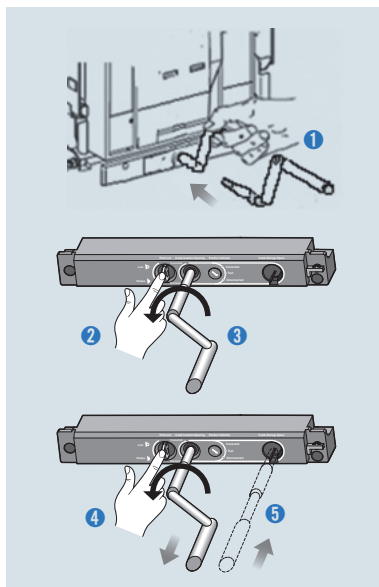
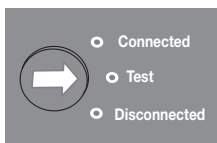
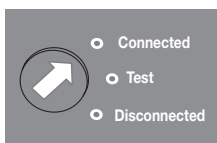

- 5) The circuit breaker indicated with 'DISCONNECTED' can be separated safely from the cradle by removing a draw in/out handle and releasing right and left locks.
- 6) Use a lifting hook to separate a circuit breaker from a cradle.

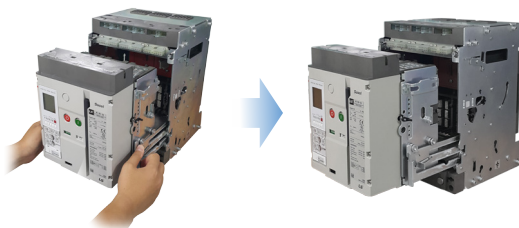

5. Mechanism operation by draw in/out section

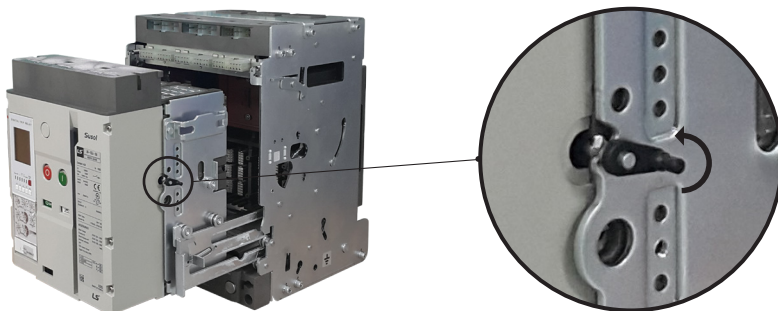

Fig 1. Mechanical Interlock (Automatic off)

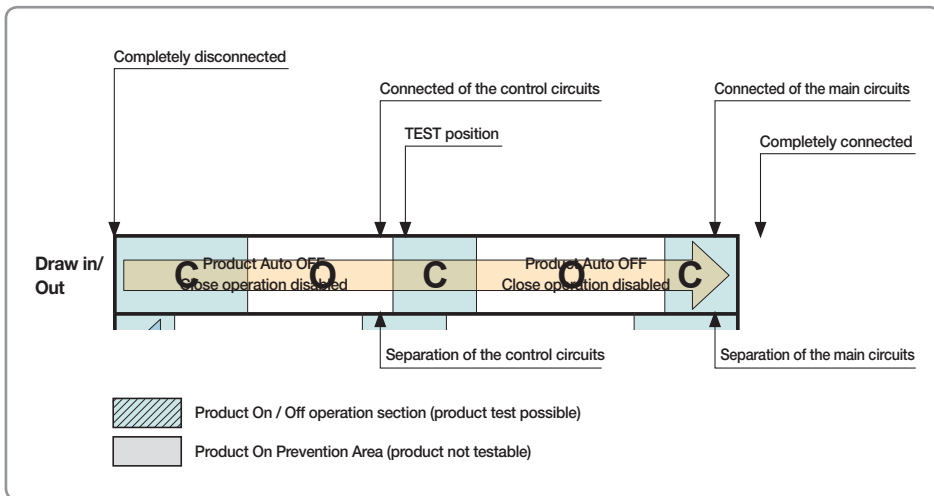

Fig2. Mechanism operation status by draw in/out section

1. Setting of ratings



Caution

- It can be possible to set the variable ratings using the rating plugs.
- The rating plugs can be used only into the 45~100% ratings of Compact ACB ampere frame.
- If it don't insert the rating plugs or it inserted under or over the ratings, the lamp will be shown "Error-1/2" with turned light on and off.

Examples)

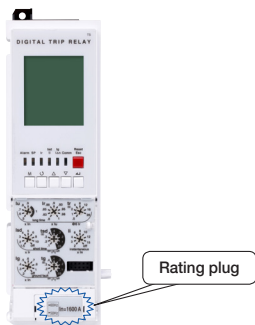

- 1) In case of a Compact ACB with 800A ratings and a 400A rating plug,
- 2) The Compact ACB can operate normally because the rating of rating plug is over 50% of the ratings of Compact ACB.



- 1) In case of a Compact ACB with 800A ratings and a 1600A rating plug,
- 2) The Compact ACB can't operate normally and is shown "Error-2 " because the rating of rating plug is over 100% of the ratings of Compact ACB.
- 3) If Insert the suitable rating plug after removed it, the Compact ACB will operate normally.



- 1) If no rating plug with a Compact ACB will be
- 2) Shown "Error-1" on OCR
- 3) When insert the suitable rating plug, a Compact ACB will operate normally.

2. Knob setting

N, A type knob configuration

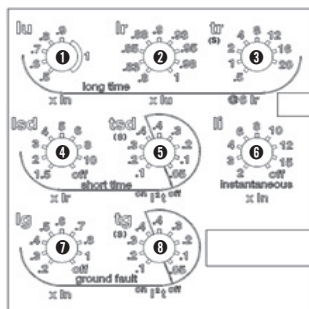

P, S type knob configuration

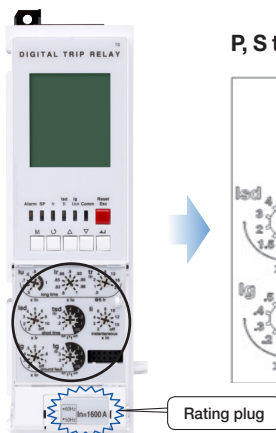
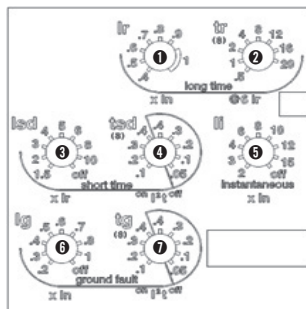

N, A type knob information

No	Type of knob	Mode	Setting step
❶	Continuous current setting	lu	(0.5-0.6-0.7-0.8-0.9-1.0) × In
❷	Long-time current setting	lr	(0.8-0.83-0.85-0.88-0.89-0.9-0.93-0.95-0.98-1.0) × lu
❸	Long-time tripping delay	tr	(0.5-1-2-4-8-12-16-20), sec @ 6 lr
❹	Short-time current Setting	ls	CAT.B: (1.5-2-3-4-5-6-8-10-off) × lr CAT.A: (1.5-2-3-4-5-6-8-None-off) × lr
❺	Short-time tripping delay	tsd	I _t off: (0.05-0.1-0.2-0.3-0.4), sec I _t on: (0.1-0.2-0.3-0.4), sec
❻	Instantaneous pick-up	li	(2-3-4-6-8-10-12-15-off) × In
❼	Ground-fault pick-up	lg	(0.2-0.3-0.4-0.5-0.6-0.7-0.8-1-off) × In
❽	Ground-fault tripping delay	tg	I _t off: (0.05-0.1-0.2-0.3-0.4) I _t on: (0.1-0.2-0.3-0.4)

S type knob information

No	Type of knob	Mode	Setting step
❶	Long-time current setting	lr	(0.4-0.5-0.6-0.7-0.8-0.9-1.0) × In
❷	Long-time tripping delay	tr	(0.5-1-2-4-8-12-16-20), sec @ 6 lr
❸	Short-time current setting	ls	CAT.B: (1.5-2-3-4-5-6-8-10-off) × lr CAT.A: (1.5-2-3-4-5-6-8-None-off) × lr
❹	Short-time tripping delay	tsd	I _t off: (0.05-0.1-0.2-0.3-0.4), sec I _t on: (0.1-0.2-0.3-0.4), sec
❺	Instantaneous pick-up	li	(2-3-4-6-8-10-12-15-off) × In
❻	Ground-fault pick-up	lg	(0.2-0.3-0.4-0.5-0.6-0.7-0.8-1-off) × In
❼	Ground-fault tripping delay	tg	I _t off: (0.05-0.1-0.2-0.3-0.4) I _t on: (0.1-0.2-0.3-0.4)

3. Connector

Division	CN1	CN2	CN3	CN4
Shape	FRONT 	REAR 	TOP 	
NO.				
1	TTL TX (Trip Relay side)	CT-Ir	ZSI OUT (+)	Power (+)
2	Current signal-Ir	Power CT (-), GND	ZSI OUT (-)	Power (-)
3	TTL RX (Trip Relay side)	CT-Is	ZSI IN (+)	-
4	Current signal-Is	Power CT (+), 24V	ZSI IN (-)	DO COM
5	Power (+), 24V	CT-It	Remote reset (+)	-
6	Current signal-It	Delay contact (-), GND	Remote reset (-)	DO #1
7	Power (-),GND	CT-In	RCD (+)	RS485 (+)
8	Current signal-In	Delay contact (+)	RCD (-)	DO #2
9	Power (-),GND	CT-Ir, override	Vr	RS485 (-)
10	Current signal COM	MTD (+), 24V	Vs	DO #3
11		CT-Is, override	Vt	
12		MTD (-)	V COM	
13		CT-It, override		
14		CT-COM		
15		In override		
16		Spare		

4. Key and LED configuration

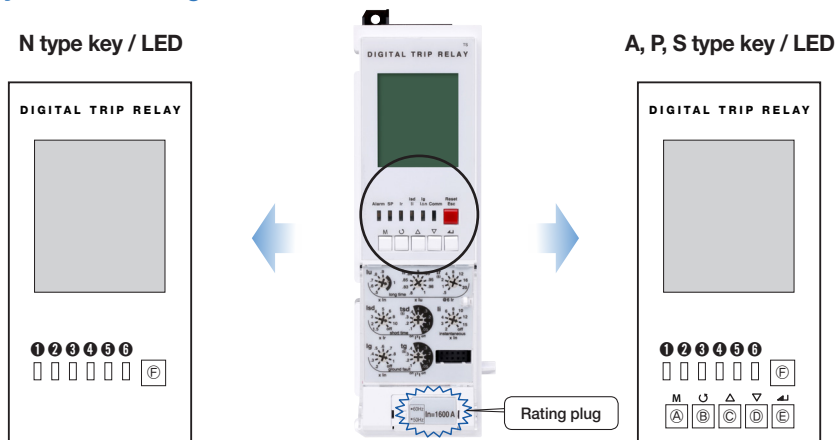

LED information

No	LED type	Operational mode
1	Alarm	LED indicating an overload (Turn on above 90%, Blink above 105%)
2	Batt / SP	Self-Protection LED and battery test LED
3	Ir	LED indicating long-time delay
4	Isd / li	LED indicating short-time or instantaneous tripping
5	Ig / IΔn	LED indicating ground-fault
6	COMM	LED indicating communication

Key configuration

No	Type of knob	Function
A	M	Menu Measurement display Menu Display, Menu display Measurement Display
B	↻	TAP Maintain the active display
C	Δ	Up cursor Move the cursor up on screen or increment a setting value
D	▽	Down cursor Move the cursor down on screen or decrement a setting value
E	↵	Enter Enter into secondary menu or setting input
F		Reset / ESC Reset errors or ESC from menu

1. Protection

N type

Long time											
Current setting (A)	$I_u = I_n \times \dots$	0.5	0.6	0.7	0.8	0.9	1.0				
	$I_r = I_u \times \dots$	0.8	0.83	0.85	0.88	0.9	0.93	0.95	0.98	1.0	
Time delay (s)	$t_r @ (1.5 \times I_r)$	12.5	25	50	100	200	300	400	500		
Accuracy : $\pm 15\%$ or below 100ms	$t_r @ (6.0 \times I_r)$	0.5	1	2	4	8	12	16	20		
	$t_r @ (7.2 \times I_r)$	0.34	0.69	1.38	2.7	5.5	8.3	11	13.8		
Short time											
Current setting (A)	$I_{sd} = I_r \times \dots$	Cat. B	1.5	2	3	4	5	6	8	10	Off
		Cat. A	1.5	2	3	4	5	6	8	N/A ^(Note)	Off
Time delay (s) @ $10 \times I_r$	tsd	I ² t Off	0.05	0.1	0.2	0.3	0.4				
		I ² t On		0.1	0.2	0.3	0.4				
	(I ² t Off)	Min. Trip Time (ms)	20	80	160	260	360				
		Max. Trip Time (ms)	80	140	240	340	440				
Instantaneous											
Current setting (A)	$I_i = I_n \times \dots$	2	3	4	6	8	10	12	15	Off	
Tripping time		below 50ms									
Ground fault											
Pick-up (A)											
Accuracy : $\pm 10\%$ ($I_g > 0.4I_n$) $\pm 20\%$ ($I_g \leq 0.4I_n$)	$I_g = I_n \times \dots$		0.2	0.3	0.4	0.5	0.6	0.7	0.8	1.0	Off
Time delay (s) @ $10 \times I_r$	tg	I ² t Off	0.05	0.1	0.2	0.3	0.4				
		I ² t On		0.1	0.2	0.3	0.4				
	(I ² t Off)	Min. Trip Time (ms)	20	80	160	260	360				
		Max. Trip Time (ms)	80	140	240	340	440				

Note) Cat.A type should be set from $I_{sd} = I_r \times 1.5$ to $I_{sd} = I_r \times 8$ for Short time, if the short time is set by $I_{sd} = I_r \times 10$, the functions are operated normally but when the problem occurred as $I_r \times 10$, the ACB can not be tripped. Then the manufacturer assumes no responsibility for the damage resulting from incorrect application of the instructions provided herein.

1. Protection

A type

Long time												
Current setting (A)	$I_u = I_{nx}...$	0.5	0.6	0.7	0.8	0.9	1.0					
	$I_r = I_{ux}...$	0.8	0.83	0.85	0.88	0.9	0.93	0.95	0.98	1.0		
Time delay (s)	$t_r@(1.5 \times I_r)$	12.5	25	50	100	200	300	400	500			
Accuracy : $\pm 15\%$ or below 100ms	$t_r@(6.0 \times I_r)$	0.5	1	2	4	8	12	16	20			
	$t_r@(7.2 \times I_r)$	0.34	0.69	1.38	2.7	5.5	8.3	11	13.8			
Short time												
Current setting (A)	$I_{sd} = I_{rx}...$	Cat. B	1.5	2	3	4	5	6	8	10	Off	
		Cat. A	1.5	2	3	4	5	6	8	N/A ^{Note1)}	Off	
Time delay (s) @ $10 \times I_r$	tsd	I ^t Off	0.05	0.1	0.2	0.3	0.4					
		I ^t On	0.1		0.2	0.3	0.4					
	(I ^t Off)	Min. Trip Time (ms)	20	80	160	260	360					
		Max. Trip Time (ms)	80	140	240	340	440					
Instantaneous												
Current setting (A)	$I_i = I_{nx}...$	2	3	4	6	8	10	12	15	Off		
Tripping time		below 50ms										
Ground fault ^{Note2)}												
Pick-up (A)												
Accuracy : $\pm 10\%$ ($I_g > 0.4I_n$) $\pm 20\%$ ($I_g \leq 0.4I_n$)	$I_g = I_{nx}...$	0.2	0.3	0.4	0.5	0.6	0.7	0.8	1.0	Off		
Time delay (s) @ $10 \times I_r$	tg	I ^t Off	0.05	0.1	0.2	0.3	0.4					
		I ^t On	0.1		0.2	0.3	0.4					
	(I ^t Off)	Min. Trip Time (ms)	20	80	160	260	360					
		Max. Trip Time (ms)	80	140	240	340	440					
Earth leakage (Option)												
Current setting (A)	$I_{\Delta n}$	0.5	1	2	3	5	10	20	30	Off		
Time delay (ms) Accuracy : $\pm 15\%$	Δt	Alarm Time (ms)	140	230	350	800	950					
		Trip Time (ms)	140	230	350	800						

Note 1) Cat.A type should be set from $I_{sd}=I_r \times 1.5$ to $I_{sd}=I_r \times 8$ for Short time, if the short time should be set by $I_{sd}=I_r \times 10$, the functions are operated normally but when the problem occurred as $I_r \times 10$, contact LSIS service center or near customer service center. Then the manufacturer assumes no responsibility for the damage resulting from incorrect application of the instructions provided herein.

Note 2) Ground fault protection and earth leakage protection can not be used at the same time.

1. Protection

P, S type

Long time											
Current setting (A)	$I_r = I_{ux}...$	0.4	0.5	0.6	0.7	0.8	0.9	1.0			
Time delay (s)	$tr@(1.5 \times I_r)$	12.5	25	50	100	200	300	400	500		
Accuracy : $\pm 15\%$ or below 100ms	$tr@(6.0 \times I_r)$	0.5	1	2	4	8	12	16	20		
	$tr@(7.2 \times I_r)$	0.34	0.69	1.38	2.7	5.5	8.3	11	13.8		
Short time											
Current setting (A)	$I_{sd} = I_{rx}...$	Cat. B	1.5	2	3	4	5	6	8	10	Off
Accuracy : $\pm 10\%$		Cat. A	1.5	2	3	4	5	6	8	N/A ^{Note1)}	Off
Time delay (s)	tsd	I st Off	0.05	0.1	0.2	0.3	0.4				
@ 10xI _r		I st On		0.1	0.2	0.3	0.4				
	(I st Off)	Min. Trip Time (ms)	20	80	160	260	360				
		Max. Trip Time (ms)	80	140	240	340	440				
Instantaneous											
Current setting (A)	$I_i = I_{nx}...$	2	3	4	6	8	10	12	15	Off	
Tripping time		below 50ms									
Ground fault											
Pick-up (A)	$I_g = I_{nx}...$		0.2	0.3	0.4	0.5	0.6	0.7	0.8	1.0	Off
Accuracy : $\pm 10\%$ ($I_g > 0.4I_n$) $\pm 20\%$ ($I_g \leq 0.4I_n$)											
Time delay (s)	tg	I st Off	0.05	0.1	0.2	0.3	0.4				
@ 10xI _r		I st On		0.1	0.2	0.3	0.4				
	(I st Off)	Min. Trip Time (ms)	20	80	160	260	360				
		Max. Trip Time (ms)	80	140	240	340	440				
Earth leakage (Option) ^{Note2)}											
Current setting (A)	$I_{\Delta n}$	0.5	1	2	3	5	10	20	30	Off	
Time delay (ms)	Δt	Alarm Time (ms)	140	230	350	800	950				
Accuracy : $\pm 15\%$		Trip Time (ms)	140	230	350	800					

Other protection	Pick-up			Time delay(s)		
	Setting range	Step	Accuracy	Setting range	Step	Accuracy
Under voltage	80V ~ OV_Pick-up	1V	$\pm 5\%$	1.2~40	0.1	± 0.1
Over voltage	UV_Pick-up ~ 980V	1V	$\pm 5\%$			
Voltage unbalance	6% ~ 99%	1%	$\pm 2.5\%$ or ($\pm 10\%$)			
Reverse power	10 ~ 500kW	1kW	$\pm 10\%$	0.2~40		
Over power	500~5000 kW	1kW	$\pm 10\%$			
Current unbalance	6% ~ 99%	1%	$\pm 2.5\%$ or ($\pm 10\%$)	1.2~40		
Over frequency	60Hz UF_Pick-up ~ 65	1Hz	$\pm 0.1Hz$			
	50Hz UF_Pick-up ~ 55	1Hz	$\pm 0.1Hz$			
Under frequency	60Hz 55Hz ~ OF_Pick-up	1Hz	$\pm 0.1Hz$			
	50Hz 45Hz ~ OF_Pick-up	1Hz	$\pm 0.1Hz$			

Note 1) Cat.A type should be set from $I_{sd}=I_r \times 1.5$ to $I_{sd}=I_r \times 8$ for Short time, if the short time should be set by $I_{sd}=I_r \times 10$, the functions are operated normally but when the problem occurred as $I_r \times 10$, contact LSIS service center or near customer service center. Then the manufacturer assumes no responsibility for the damage resulting from incorrect application of the instructions provided herein.

Note 2) Earth leakage function is available with ZCT or external CT.

2. Operation characteristics

Long-time delay (L)

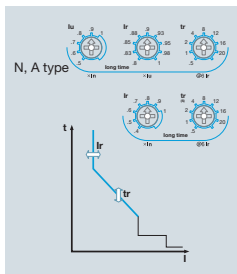

The function for overload protection which has time delayed characteristic in inverse ratio to fault current.

1. Standard current setting knob: Ir
 - 1) Setting range in P type & S type: $(0.4-0.5-0.6-0.7-0.8-0.9-1.0) \times I_n$
 - 2) Setting range in N type and A type: $(0.4-1.0) \times I_n$
 - lu: $(0.5-0.6-0.7-0.8-0.9-1.0) \times I_n$
 - lr: $(0.8-0.83-0.85-0.88-0.9-0.93-0.95-0.98-1.0) \times I_n$
2. Time delay setting knob: tr
 - Standard operating time is based on the time of $6 \times I_r$
 - Setting range: 0.5-1-2-4-8-12-16-20sec (8 modes)
3. Relay pick-up current
 - When current over $(1.15) \times I_r$ flows in, relay is picked up.
4. Relay operates basing on the largest load current among R/S/T/N phase.

Short-time delay (S)

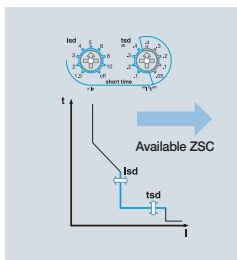

The function for fault current (over current) protection which has definite time characteristic and time delayed in inverse ratio to fault current.

1. Standard current setting knob: Isd
 - Setting range: CAT.B, 1.5-2-3-4-5-6-8-10-Off $\times I_r$
 - CAT.A, 1.5-2-3-4-5-6-8-N/A-Off $\times I_r$
2. Time delay setting knob: tsd
 - Standard operating time is based on the time of $10 \times I_r$.
 - Inverse time (I2t On): 0.1-0.2-0.3-0.4sec
 - Definite time (I2t Off): 0.05-0.1-0.2-0.3-0.4sec
3. Relay operates basing on the largest load current among R/S/T/N phase.
4. Relay can operate at instantaneous current through ZSI
5. Cat.A type should set $I_{sd} = I_r \times 8$ for Short time, if short time is set
 - $I_{sd} = I_r \times 10$, it do not operate normally.

Instantaneous (I)

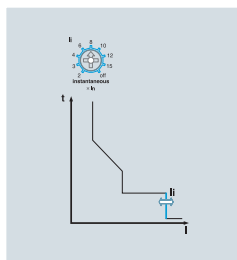

The function for breaking fault current above the setting value With in the shortest time to protect the circuit from short-circuit.

1. Standard current setting knob: Ii
 - Setting range: $(2 - 3 - 4 - 6 - 8 - 10 - 12 - 15 - \text{Off}) \times I_n$
2. Relay operates based on the largest load current among R/S/T phase.
3. Total breaking time is below 50ms.

2. Operation characteristics

Ground fault (G)

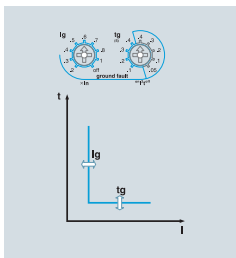

The function for breaking ground fault current above setting value after time-delay to protect the circuit from ground fault.

- Standard setting current knob: I_g
 - Setting range: $(0.2 - 0.3 - 0.4 - 0.5 - 0.6 - 0.7 - 0.8 - 1.0 - \text{Off}) \times I_n$
- Time delay setting knob: t_g
 - Inverse time ($I2t \text{ On}$): $0.1 - 0.2 - 0.3 - 0.4\text{sec}$
 - Definite time ($I2t \text{ Off}$): $0.05 - 0.1 - 0.2 - 0.3 - 0.4\text{sec}$
- Ground fault current is the vector sum of each phase current. Therefore, 3Pole products may operate under its phase-unbalance including ground fault situation. $(R+S+T \text{ Phase})$
- When the ZSI function is set, the protection operation will take place instantaneously with input absence by downstream devices. It is advised to disable the ZSI function on the last downstream device.
- Ground-fault functions are basically provided with products equipped with a trip relay through its internal CT that is embedded in each phase. (But, it can't be used with earth - leakage protection function at the same time)

Earth leakage (G)

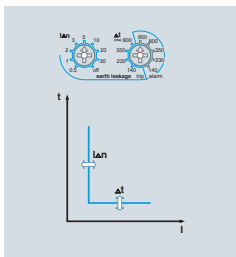

The function for breaking earth leakage current above setting value after time delay to protect the circuit from earth leakage. (A, P, S type)

- Standard setting current knob: I_n
 - Setting range: $0.5-1-2-3-5-10-20-30-\text{OFF}(A)$
- Time delay setting knob: t
 - Trip time: $140-230-350-800\text{ms}$
 - Alarm time: $140-230-350-800-950\text{ms}$
- Settings within its alarm range will prevent its breaker from tripping but activating its alarm.
- This function is enabled and can be used only with private external CT(secondary output 5A) selected by customers.
- When the ZSI function is set, the protection operation will take place instantaneously with input absence by downstream devices. It is advised to disable the ZSI function on the last downstream device.

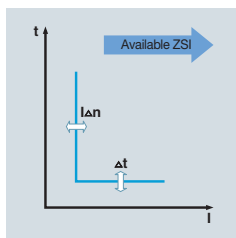
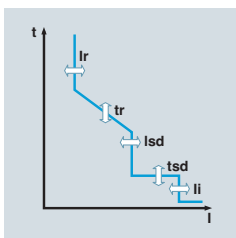

1. Menu tree



Caution

- Each movement within Menu Tree can be done by using Menu and ESC button.
- Use UP(Δ)/Down(∇) button to move around each setting information under Relay Setting Display.
- If not pressing any button for 30seconds after moving to other screens, the screen moves back to Measurement Display and any relevant data will not be saved.

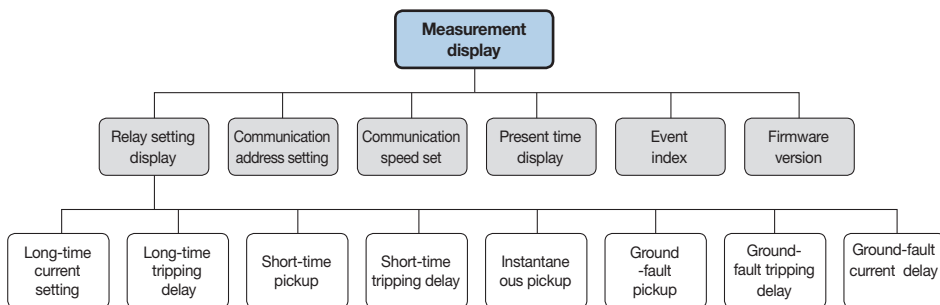

2. LCD segment

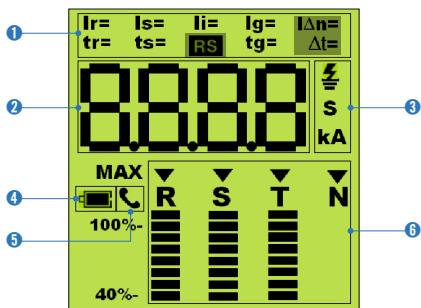

No	Contents
①	Segment that displays the types of relay current and time - Display of Setting values or Event
②	Segment that displays numbers or characters - Current, Time, and Simple character
③	Segment that displays the unit of current and time.
④	Low Battery Segment - LED flickers at 2~3 second interval if the voltage of 3.6V Lithium battery built in OCR is discharged below 2.5V.
⑤	Communication Segment - Upon answering to communication, it is displayed on the screen of Address and Speed Setting.
⑥	Segment which displays the measured current and the load rate of each phase - Inverted triangle indicates the current of phase which is being displayed on Measurement Display. - Load rate of R/S/T phase in proportion to Ir

When OCR is plugged in for the first time, all segments will be shown for approximately a second, and then return to Measurement Display.

3. Button configuration

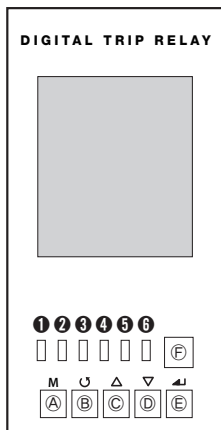

Caution

- OCR A type is composed of 6 buttons, and its LCD Back Light comes on for 30s if it sensing any button pressed during its operation.
- After 30 seconds under Idle condition, it moves back to Measurement Display page.
- If pressing ESC/RESET button in case of no power supply with OCR, BATT LED will come on to indicate the residual quantity of battery.
- If pressing ESC/RESET button in case of existing power supply with OCR, the status of LED only can be checked, not checking residual quantity of battery
- Only BATT LED turns on while pressing ESC/RESET button and other LEDs will turn on for 1~2 seconds after releasing ESC/RESET button.
- If Compact ACB breaking the fault current normally, the information of cause for accident will be informed to users by turning on Indication LED.
- At this time Indication LED is operated by a separate battery built in OCR. Therefore, turn it off by pressing ESC/RESET button when discovering the cause of fault.

4. Measurement display

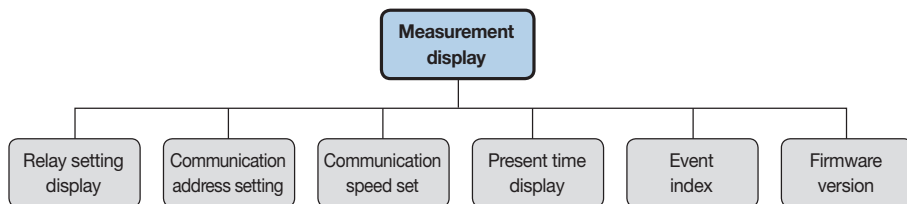

Display	Button	Contents
		1. The current of R, S, T, N phase are displayed in rotation at 3 second interval 2. At this very moment, the inverted triangle is moving sideways from left to right to show which phase is being displayed on LCD currently, and the below bar graphs represent each phase's load rate in scale (40%~110%).
		If pressing TAP button to display only one phase value exclusively on the screen without displaying each phase's current in rotation, the triangle sign(Δ) will appear at the top-right side of LCD screen. ※ This screen-freeze can be apply at other screens as well.
		The phase which will be displayed exclusively can be selected by pressing Up / Down cursor.

5. Relay setting display

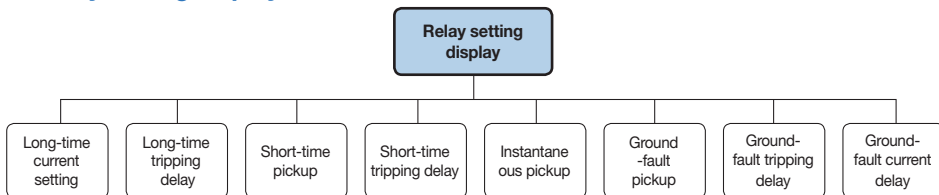

Display		Button	Contents
Long-time	Current 	M △ ▽	If pressing a menu button once from its normal measurement display will switch to the screen that displays relay setting values. An initial screen of measurement setting display is arranged for long-time delay current setting, and other setting values can be seen by pressing Up/Down cursor.
	Delay time 	M △ × 1	If pressing 'Up cursor' once from the relay setting display, the setting value of long-time tripping delay will be displayed.
Short-time	Current 	M △ × 2	If pressing 'Up cursor' two times on the relay setting display, the setting value of short-time tripping delay will be displayed.
	Delay time 	M △ × 3	If pressing 'Up cursor' three times on the Relay setting Display, the setting time of short-time tripping delay will be displayed. At this time, one larger value than the initial one will be displayed because LSB of time setting value is set in case of I2t is On. For example, if it is of I2t 0.400sec on setting, 0.401 will be displayed.
Instantaneous	Current 	M △ × 4	If pressing 'Up cursor' four times on the relay setting display, Instantaneous pick up setting value will be displayed.
Ground fault	Pick up 	M △ × 5	If pressing 'Up cursor' five times on the relay setting display, the setting value of ground-fault pickup will be displayed.
	Tripping delay 	M △ × 6	If pressing 'Up cursor' six times on the relay setting display, the setting value of ground-fault tripping delay will be displayed. At this time, one larger value than the initial one will be displayed because LSB of time setting value is set in case of I2t is On. For example, if it is of I2t 0.400sec on setting, 0.401 will be displayed.
	Current delay 	M △ × 7	If pressing 'Up cursor' seven times on the relay setting display, the setting current of ground fault will be displayed. At this time, the 10~100% of I _n will be displayed and other values out of this range will be indicated as "----".



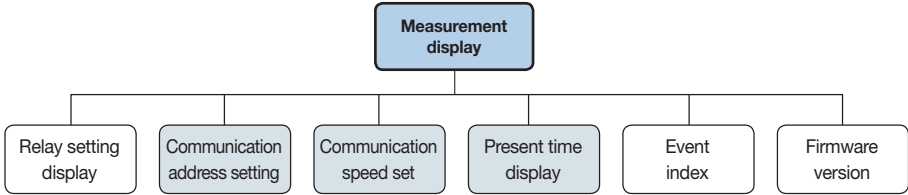

5. Relay setting display

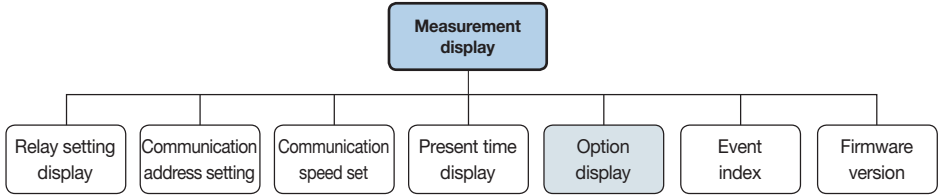

		Display	Button	Contents
Communication	Address		M × 2 △ ▽	<ol style="list-style-type: none"> If pressing 'MENU' button 2 times from the measurement display, move to communication address setting screen. Communication Address can be set from 1 to 247. If pressing 'Up' button short, Address increases by 1. If pressing and holding 'Up' button, Address increases by 10.
			↵	<ol style="list-style-type: none"> Press 'Enter' button to save the setting, otherwise press 'ESC/RESET' button to move back to Measurement display. If successfully saved, "SAVE" is displayed on screen and move to measurement display and if pressing ESC/RESET button, move to measurement display without saving.
	Speed		M × 3 △ ▽	<ol style="list-style-type: none"> If pressing 'MENU' button 3 times from measurement display screen, move to communication speed setting screen. Communication speed can be set through baud rate 38400/19200/9600. If pressing 'Up / Down' button, the value of Baud rate rolling over will be displayed.
			↵	<ol style="list-style-type: none"> Press 'Enter' button to save the setting, otherwise press 'ESC/RESET' button to move back to measurement display. If successfully saved, "SAVE" is displayed on screen and move to measurement display and if pressing 'ESC/RESET' button, move to measurement display without saving.
Time	View		M × 4	<ol style="list-style-type: none"> If pressing 'MENU' button 4 times from Measurement display, move to present time display. The present time is displayed with 'hour' and 'minute' by 24H type and dot between hour and minute turns on and off every second. Unless present time is set, present time will be set '1 hour 1minute' as initial time is set as '1hour 1minute 1 second January 1st, 2000'.
			↵	<ol style="list-style-type: none"> If pressing 'Enter' button once from time display, move to set-up time display. <ol style="list-style-type: none"> ▼▼: It's on the left and year/month will be displayed.(February/2013) Change using Up/Down button on the year setting mode, and then put 'Enter' button to switch to month setting mode. (User can change between 2000 to 2099. 20 is clipped) Change using Up/Down button on the month setting mode, and then put 'Enter' button to switch to day setting mode. (User can change between 1 to 12.)
	Set-up		↵ × 3	<ol style="list-style-type: none"> ▼▼: It's on the center and day/time will be displayed. (18th/11 hour) Change using Up/Down button on the day setting mode, and then put 'Enter' button to switch to hour setting mode. (User can change between 1 to 31. Leap year/month is not existed.) Change using Up/Down button on the hour setting mode, and then put 'Enter' button to switch to minute setting mode. (User can change between 0 to 23.)
			↵ × 5	<ol style="list-style-type: none"> ▼▼: It's on the right and minute/second will be displayed. (5 minutes 11 seconds) Change using Up/Down button on the minute setting mode, and then put 'Enter' button to switch to second setting mode.(User can change between 0 to 59 both minute and second) If user press 'Enter' button on the second mode, time is saved in the RTC and then, user can see "SAVE" one second and the initial screen will be returned. If user press reset button, time isn't saved and the initial screen will be returned.

5. Relay setting display

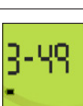
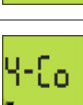
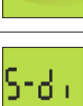

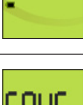
Display	Button	Contents
Options	 M × 5	<ol style="list-style-type: none"> 1. If pressing 'MENU' button 5 times from the measurement display, move to Option display screen. 2. On the first screen, the "Blocking Time" of OCGR can be set. 3. Setting range: 0-60s 4. Default set value: 0s 5. After press the Enter, the range value can be set by pushing "Up, Down" buttons.
	 M × 5 Δ × 1	<ol style="list-style-type: none"> 1. OCGR operation mode can be set by pressing 'Up' button 1 time from the Option display screen. 2. Modes: Trip / Alarm 3. Default set value: Trip 4. The value can be changed by pressing "Up, Down" buttons after press Enter.
	 M × 5 Δ × 2	<ol style="list-style-type: none"> 1. Thermal operation mode can be set by pressing 'Up' button 2 times from the Option display screen. 2. Default set value: 49 3. The value can be changed by pressing "Up, Down" buttons after press Enter.
	 M × 5 Δ × 3	<ol style="list-style-type: none"> 1. Thermal measurement operation mode can be set by pressing 'Up' button 3 times from the Option display screen. 2. Modes: Hot / Cold 3. Default set value: Cold 4. The value can be changed by pressing "Up, Down" buttons after press Enter.
	 M × 5 Δ × 4	<ol style="list-style-type: none"> 1. ZSI operation mode can be set by pressing 'Up' button 4 times from the Option display screen. 2. Modes: Disable / Enable 3. Default set value: Disable 4. The value can be changed by pressing "Up, Down" buttons after press Enter.
	 M × 5 Δ × 5	<ol style="list-style-type: none"> 1. Frequency can be checked by pressing 'Up' button 5 times from the Option display screen. 2. Frequency: 60Hz / 50Hz 3. This function can read only dip switch value(already set frequency) at rating plug.
		<ol style="list-style-type: none"> 1. Every display is moved with save the changed values when press the Enter after change the values.

5. Relay setting display

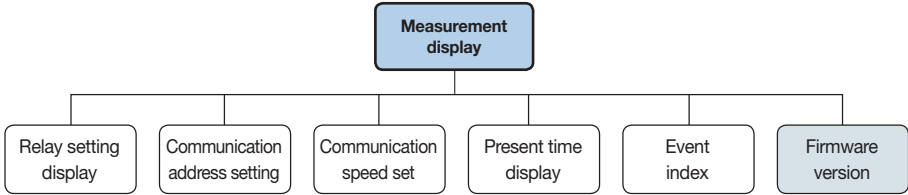

	Display	Button	Contents
Event		M × 5	<ol style="list-style-type: none"> If pressing 'MENU' button 5 times from the measurement display, move to Event Index. On the Event Index, the information of fault events is shown on screen up to 10 fault and each information displays fault current, a type of fault, fault phases, occurring time which includes second, minute, hour, date, month and year.
			<ol style="list-style-type: none"> "li=": Fault: long time/short time/instantaneous/ground fault "1600A": Fault current "▼": Fault phase: R, S, T, N ACB OCRN/A type can save 10 events and Event Index indicates events order. When displaying the latest event, only one segment will be showed on the Event Index and if pressing 'Up' button, Segment will be increased and the former saved event will be displayed.
			<ol style="list-style-type: none"> If there is no date in Event Index 'Empty' will be displayed.
			<ol style="list-style-type: none"> If pressing 'Enter' from Event Index, the time information of relevant events is displayed. <ul style="list-style-type: none"> ① : Displaying the 7th Event (Event Index) ② : Displaying Event Year/Month ③ If pressing 'Enter' once, the information of Year/Month will be displayed. Left screen indicates "January, 2007"
		× 2	<ol style="list-style-type: none"> If pressing 'Enter' 2 times, the information of Date/Time will be displayed. <ul style="list-style-type: none"> ④: The current screen indicates "1 o'clock, 8th" ⑤: Displaying Event Date/Time ⑥: Event Index: Displaying the 7th Event
		× 3	<ol style="list-style-type: none"> If pressing 'Enter' 3 times, the information of minute/second will be displayed. <ul style="list-style-type: none"> ⑦: The current screen is to indicate "12 minutes 51 seconds". ⑧: Displaying Event Minutes/Second ⑨: Event Index: Displaying the 7th Event
Firmware version		M × 6	<ol style="list-style-type: none"> If pressing 'MENU' button 6 times from Measurement Display, move to Firmware Version.

1. Long-time protection

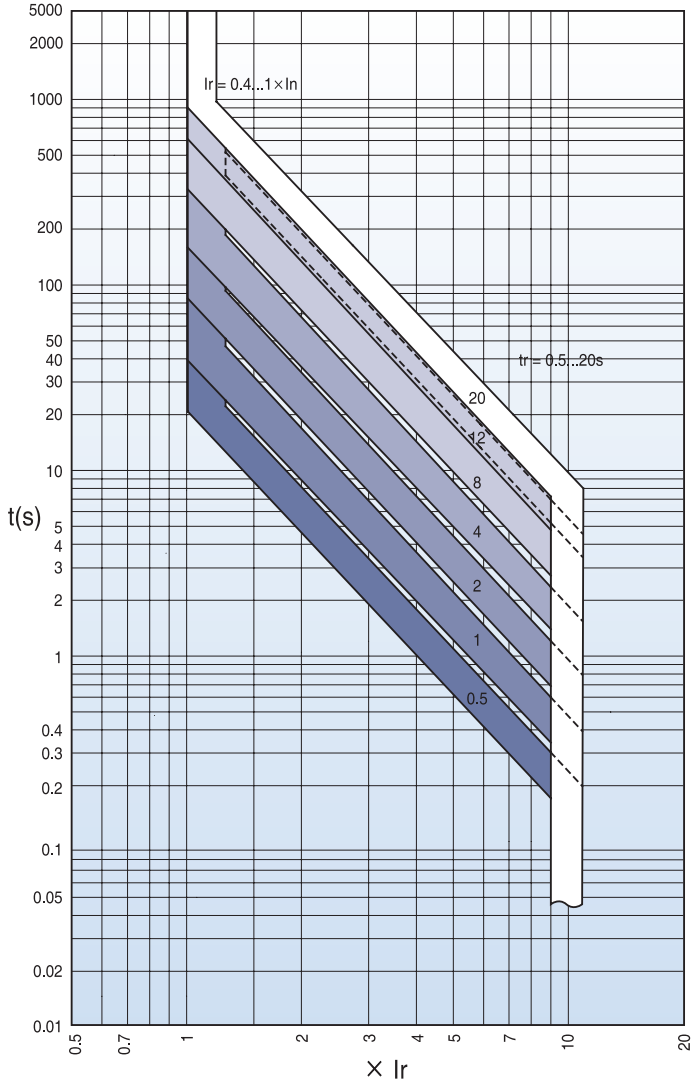

2. Short-time protection

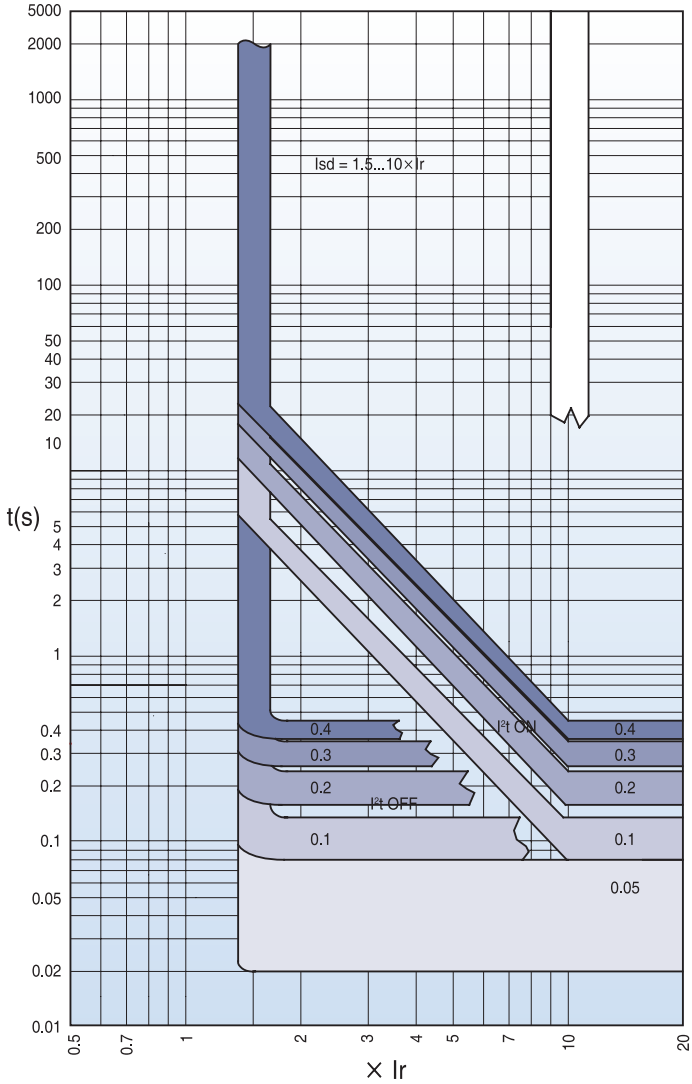

3. Instantaneous / Ground-fault protection

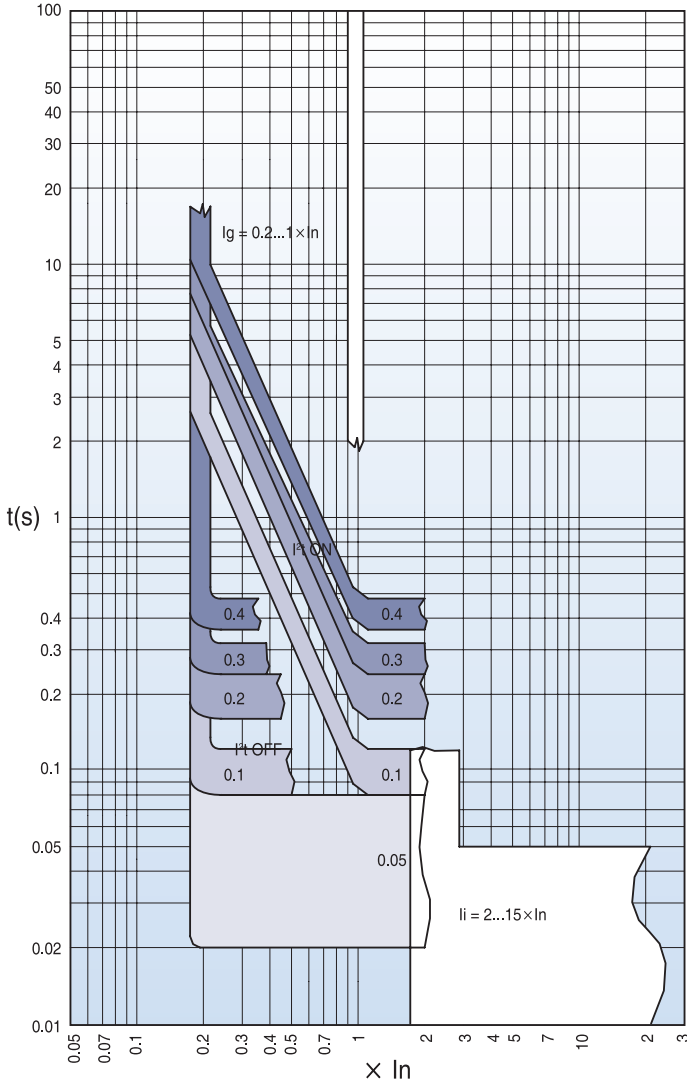

4. IDMTL

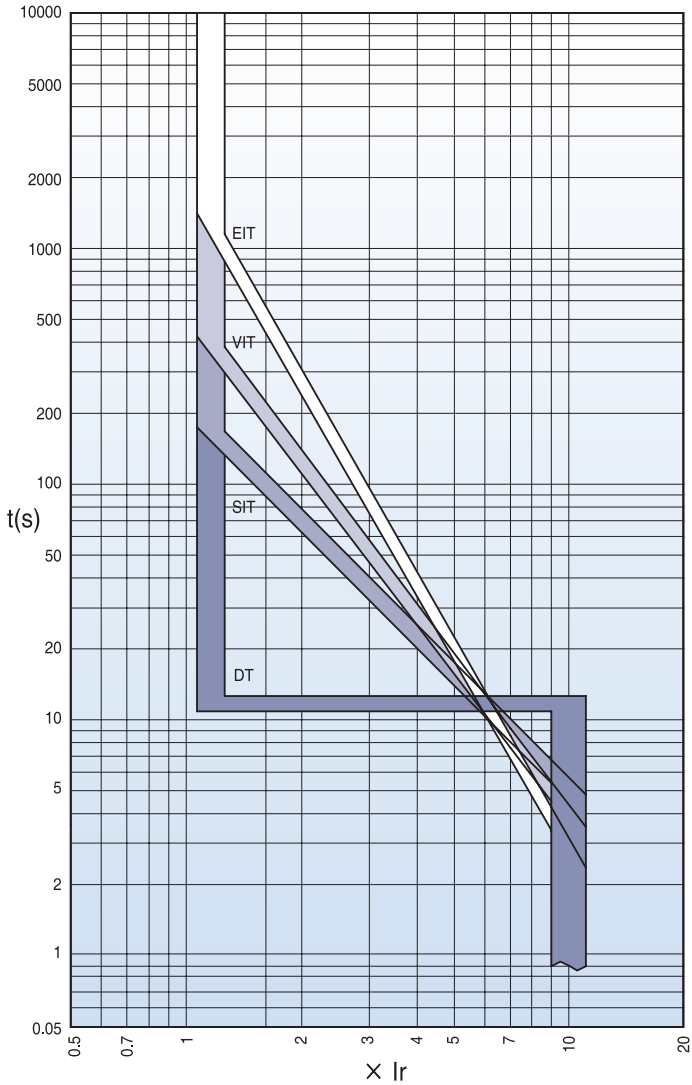

1. Inspection and maintenance cycle

The purpose of inspection for Compact ACB is to prevent the accidents in advance and maintain the performance of it by changing timely the consumable and deteriorative parts. Please make sure the following guideline specified the method for inspection & cycles before using of the equipment.

Maintenance cycle upon using condition

Using condition	Environments	Specific examples	Inspection cycle	Replacement cycle
General environment for a use	Location with clean & dry air	Electrical rooms with dust proof & air-conditioner	Once every 2 years	Within approx. 10 years
	Indoor location with little dust Location without corrosive gases	Distribution panel or individual electrical room without dust proof & air conditioner	when operating after installation under the usage environment over 70 times	
Special environment for a use	Location with salinity, high temperature gases such as sulphur dioxide and hydrogen sulphide	Geothermal power plants, waste water treatment plants, steel mills, paper factories, pulp factories, etc.	Once every 1 year	Within approx. 7 years
	Locations with harmful or corrosive gases where humans cannot stay for a long time	Chemical factories, quarries, mining areas, etc.	Once every half a year	Within approx. 5 years

* Add grease to every operational part at every maintenance cycle

2. Defects and troubleshooting guideline

Troubleshooting guideline

Types of defect	Cause	Countermeasure
The breaker is opened but Fault Trip Reset button does not come out.	1. Voltage does not exist or UVT is damaged.	1. Check voltage. Replace damaged UVT.
	2. Voltage disturbance occurred to the trip device.	2. Check voltage supply part.
The breaker is opened simultaneously with the closing operation and the Fault Trip Reset button comes out.	1. In state of short-circuit	1. Remove cause; Check condition of breaker before re-closing.
	2. Excess current is too high at closing operation.	2. Revise network or change setting of trip device.
OPEN operation is done manually but not from remote.	1. Voltage supply from the trip device is too low. $V < 0.7V_n$	1. Check voltage supply. (0.7~1.1Vn)
	2. Defect on UVT circuit	2. Replace UVT.
OPEN operation does not work manually.	1. Damage on the mechanism	1. Contact AS center.
	2. Deposition of main circuit.	2. Contact AS center.
Breaker does not close neither manually nor remotely.	1. Closing operation at state of short-circuit.	1. Remove cause; Check condition of breaker.
	2. Fault Trip Reset button does not reset.	2. Reset Fault Trip Reset button.
	3. Unstable draw-in/out state of the product.	2. Reset Fault Trip Reset button.
	4. Anti-pumping function	4. Re-operate after removing power of the closing coil.
	5. Closing spring of breaker is not charged.	5. Check power supply of the charging motor. Check if manual charging works. Contact AS center or replace charging motor if necessary.
	6. Power supply problem of the closing coil.	6. Remove power supply of the closing coil. Apply power again after checking the breaker's closing availability. Contact AS center if manual charging is unavailable.
	7. Power supply problem of the trip coil.	7. Remove power supply of the trip coil.
	8. Insufficient power supply of the UVT or defect.	8. Apply voltage ($V > 0.85V_n$) to the auxiliary switch and try closing operation using the closing coil.
	9. Locked state of the breaker under open position	9. Check if the closing error state is normal.
	10. In case breaker is interlocked.	10. Release interlock.
Closes manually but does not close from remote.	1. Inappropriate voltage supply of the closing coil.	1. Check voltage supply of the closing coil. (0.85~1.1Vn)
	2. Defect of the closing coil's open circuit.	2. Replace closing coil.
Does not charge electrically.	Wrong voltage supply to spring charging motor.	1. Check voltage supply.
		2. Check the circuit of charging motor.
		3. Try reset operation and if there is a problem or defect. Contact local AS center and replace charging motor.
Crank handle for draw-in/out does not get inserted.	1. No opening of the crank insertion by pressing Open button.	1. Insert while pressing Open button.
	2. Under Padlock or interlock.	2. Remove padlock or interlock.
	3. Not putting the product into the cradle securely.	3. Push product into cradle securely.
Breaker does not get drawn out.	1. Crank handle is inserted.	1. Remove crank handle.
	2. Breaker is not in Disconnected position.	2. Draw out to the Disconnected position completely.
	3. Under Padlock or interlock.	3. Remove padlock or interlock.
Breaker is not drawn in completely. (It is not in the Connected position)	1. The cradle and main frame of the breaker do not fit.	1. Check if cradle fits with main frame.
	2. Inappropriate position of the cluster.	2. Move cluster to the right position.
	3. Safety shutter is under interlock.	3. Remove interlock.

1. Wiring diagram

This diagram is based on "CONNECTED" position of a circuit breaker and Opening, Motor charging, Releasing of locking plate should be normal condition.

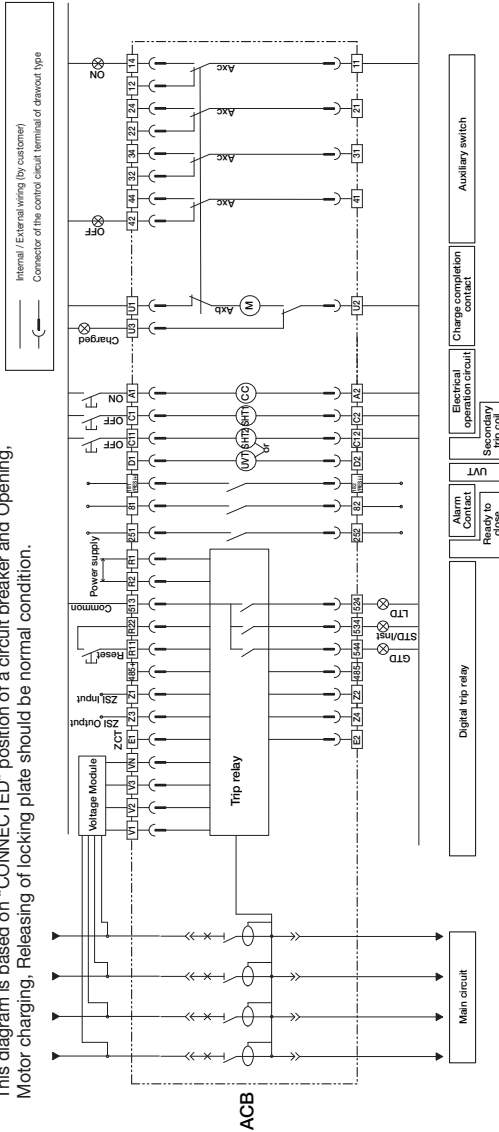

Terminal code description

D1	Z1	Z2	Voltage input terminal of UVT coil	
B1	B2	Z3	Alarm "a" contact	
U3	U2	E1	Alarm2 "a" contact or RES Coil	
U1	U2	Z51	Z52	Ready to close switch
A1	A2	R1	R2	Control power for trip unit
C1	C2	311	344	Fault cause indication contacts
C11	C12	R11	R22	Alarm reset (trip cause LEDs, contacts)

Z1	Z2	ZSI input
Z3	Z4	ZSI output
E1	E2	ZCT
V1	V3	Voltage module
485	485C	RS-485 Communication
311	344	Cell switch

Axc	Auxiliary switch
LTD	Long time delay trip indicator
STD/Inst	Short time delay/instantaneous
GTD	Ground fault trip indicator
CL1-CL4	Cell switch
M	Motor
CC	Closing coil
311	1st Shunt coil
312	2nd Shunt coil
UVT	UVT coil

Accessory code description

Axc	Auxiliary switch
LTD	Long time delay trip indicator
STD/Inst	Short time delay/instantaneous
GTD	Ground fault trip indicator
CL1-CL4	Cell switch
M	Motor
CC	Closing coil
311	1st Shunt coil
312	2nd Shunt coil
UVT	UVT coil

- Note) 1. The diagram is shown with circuit de-energized, all devices open and charged and relays in normal position
 2. Relay is normal condition and charging type is "Off-Charging"
 3. The standard of auxiliary contact is 4C.
 4. Option
 - Ready to close contact, Trip alarm contact, UVT coil, Fully charged contact, secondary trip coil
 - Temperature module, Voltage module, ZCT, ZSI
 5. Please consult us for the use of ZSI (Zone selective interlocking).
 6. For connecting RS-485 verify if the polarity is correct
 7. Contact configuration for Cell Switch can be changeable if necessary

1. Wiring diagram

SC (Standard with "ON" charging type for TCS)

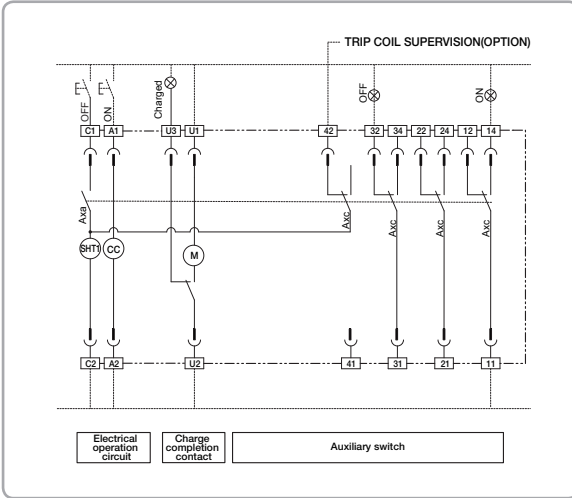

Options

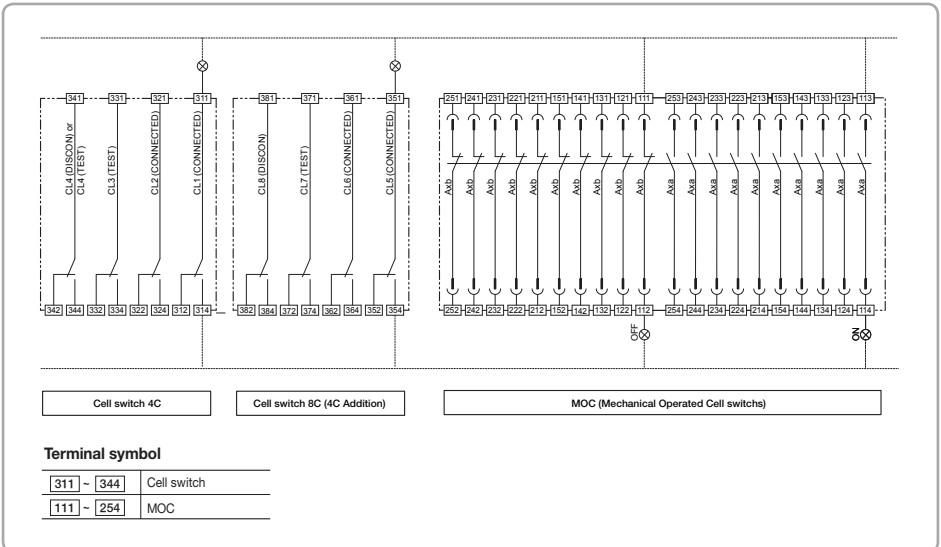



Safety Instructions

- For your safety, please read user's manual thoroughly before operating.
- Contact the nearest authorized service facility for examination, repair, or adjustment.
- Please contact qualified service technician when you need maintenance. Do not disassemble or repair by yourself!
- Any maintenance and inspection shall be performed by the personnel having expertise concerned.



www.lsis.com

79563471001

■ Head Quarter

127 LS-ro (Hogye-dong) Dongan-gu, Anyang-si,
Gyeonggi-Do, 14119, Korea
Tel. 82-2-2034-4902, 4684, 4429 Fax: 82-2-2034-4555

■ Overseas Subsidiaries

- **LSIS(Dalian) Co., Ltd.** (Dalian, China)
Tel: 86-411-8730-7510 Fax: 86-411-8730-7560 E-Mail: dskim@lsis.com
- **LSIS(Wuxi) Co., Ltd.** (Wuxi, China)
Tel: 86-510-8534-6666-9005 Fax: 86-510-8534-4078 E-Mail: sojin@lsis.com
- **LS VINA Industrial Systems Co., Ltd** (Hanoi, Vietnam)
Tel: 84-4-6275-8055 Fax: 84-4-3882-0220
- **LSIS Middle East FZE** (Dubai, U.A.E.)
Tel: 971-4-886-5360 Fax: 971-4-886-5361 E-Mail: shunlee@lsis.com
- **LSIS Europe B.V.** (Amsterdam, Netherlands)
Tel: 31-20-654-1420 Fax: 31-20-654-1429 E-Mail: europartner@lsis.com
- **LSIS Japan Co., Ltd.** (Tokyo, Japan)
Tel: 81-3-6268-8241 Fax: 81-3-6268-8240 E-Mail: bmin@lsis.com
- **LSIS USA Inc.** (Chicago, U.S.A)
Tel: 1-800-891-2941 Fax: 847-383-6543 E-Mail: sales.us@lsis.com



Technical Question or After-sales Service

Customer Center-Quick Response Service, Excellent technical support | **82-1644-5481**

■ Overseas Branches

- **LSIS Shanghai Office** (China)
Tel: 86-21-5237-9977 Fax: 86-21-5237-7189
- **LSIS Beijing Office** (China)
Tel: 86-10-5761-3127 Fax: 86-10-5761-3128 E-Mail: htroh@lsis.com
- **LSIS Guangzhou Office** (China)
Tel: 86-20-8326-6784 Fax: 80-20-8326-6287 E-Mail: sojhtroh@lsis.com
- **LSIS Qingdao Office** (China)
Tel: 86-532-8501-6058 Fax: 86-532-8501-6057 E-Mail: htroh@lsis.com
- **LSIS Chengdu Office** (China)
Tel: 86-28-8670-3200 Fax: 86-28-8670-3203 E-Mail: yangcfc@lsis.com
- **LSIS ShenYang Office** (China)
Tel: 86-24-2321-9050 Fax: 86-24-8386-7210 E-Mail: yangcfc@lsis.com
- **LSIS Jinan Office** (China)
Tel: 86-531-8699-7826 Fax: 86-531-8697-7628 E-Mail: yangcfc@lsis.com
- **LSIS Co., Ltd. Tokyo Office** (Japan)
Tel: 81-3-6268-8241 Fax: 81-3-6268-8240 E-Mail: jschuna@lsis.com
- **LSIS Co., Ltd. Rep. Office** (Vietnam)
Tel: 84-8-3823-7890 E-Mail: sjbaik@lsis.com
- **LSIS Moscow Office** (Russia)
Tel: 7-499-682-6130 E-Mail: info@lsis-ru.com
- **LSIS Jakarta Office** (Indonesia)
Tel: 62-21-293-7614 E-Mail: dioh@lsis.com