



Beyond

™

**Susol UL DC
Switch-Disconnecter**



LS ELECTRIC

1500Vdc UDA Series for PV/ESS System

1. PV/ESS system applications
2. 100% rated switch disconnecter (molded circuit switch)
3. Draw-out or fixed mount: 3- or 4-pole construction
4. High short circuit withstand capacity: 100kA
5. Accessories common to the UL Susol series
6. Maintains the overall dimensions of UL Susol series
7. UL listed (UL489B and UL489F)

Susol

Contents

DC Switch-disconnectors

• Product features	03
• Ordering	04
• Ratings	06
• Common busbar	07
• Circuit diagram	08
• Dimensions	09
• Technical information	27

Rated nominal voltage: 1250 Vdc (4P) / 800 Vdc (3P)

Rated maximum voltage: 1500 Vdc (4P) / 1000 Vdc (3P)

Rated current: 2500 A / 4000 A

Short circuit rating: 85 kA / 100 kA

800~2500AF

800~4000AF



H = 430mm

W = 419mm

4P



W = 527mm

4P

Codes and standards

UDA series products are manufactured and tested in accordance with the following standards





UL 489 B

UL 489 F

Mark	File Number
	E493630 (UL 489 B, Molded circuit switch)
	E491572 (UL 489 F, Molded circuit switch)
	E223241 (Accessories)
	E494756 (Adapters)

UL489 B: Molded-Case Switches for Use with Photovoltaic(PV) Systems

UL489 F: Molded-Case Switches for Use with Battery Power Supplies

		Susol UDA-40E4-00A	
PV / BPS Molded Circuit Switch UL 489B (50°C) / UL 489F (40°C)			
		File E326950 File E491572	
Rated Current (A)	4000		
Pole	4P		
Rated Nominal Voltage (V dc)	1250		
Rated Maximum Voltage (V dc)	1500		
Short Circuit Rating (kA)	100		
For 100 kA short circuit current at 1250 V dc nominal 1500 V dc maximum rating the switch is suitable only for use with BPS			
For ungrounded system only / Remotely operated Caution—Does not provide overcurrent protection			
Cat.		M2D2D2HX 000U2 UL	
		MFG, Date :	2017.08
		Serial No. :	170810-7270.01
MADE IN KOREA			

Ordering

Main frame

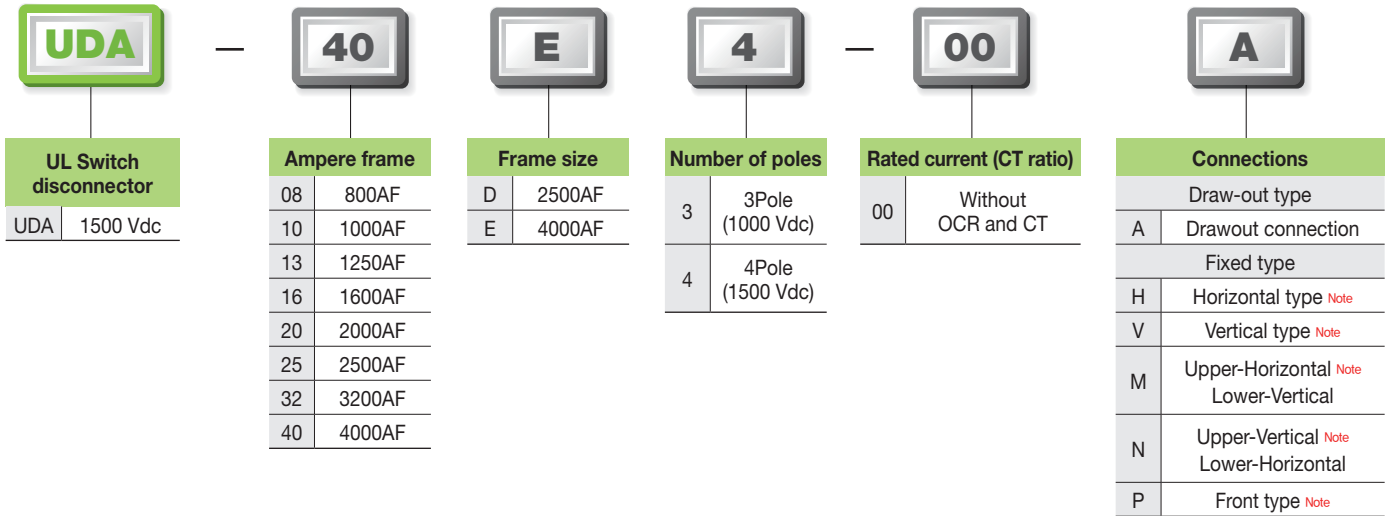

Notes: 1. 25D and 40E are vertical type only
2. 08-16D and 08-25E are front terminal only

Cradle

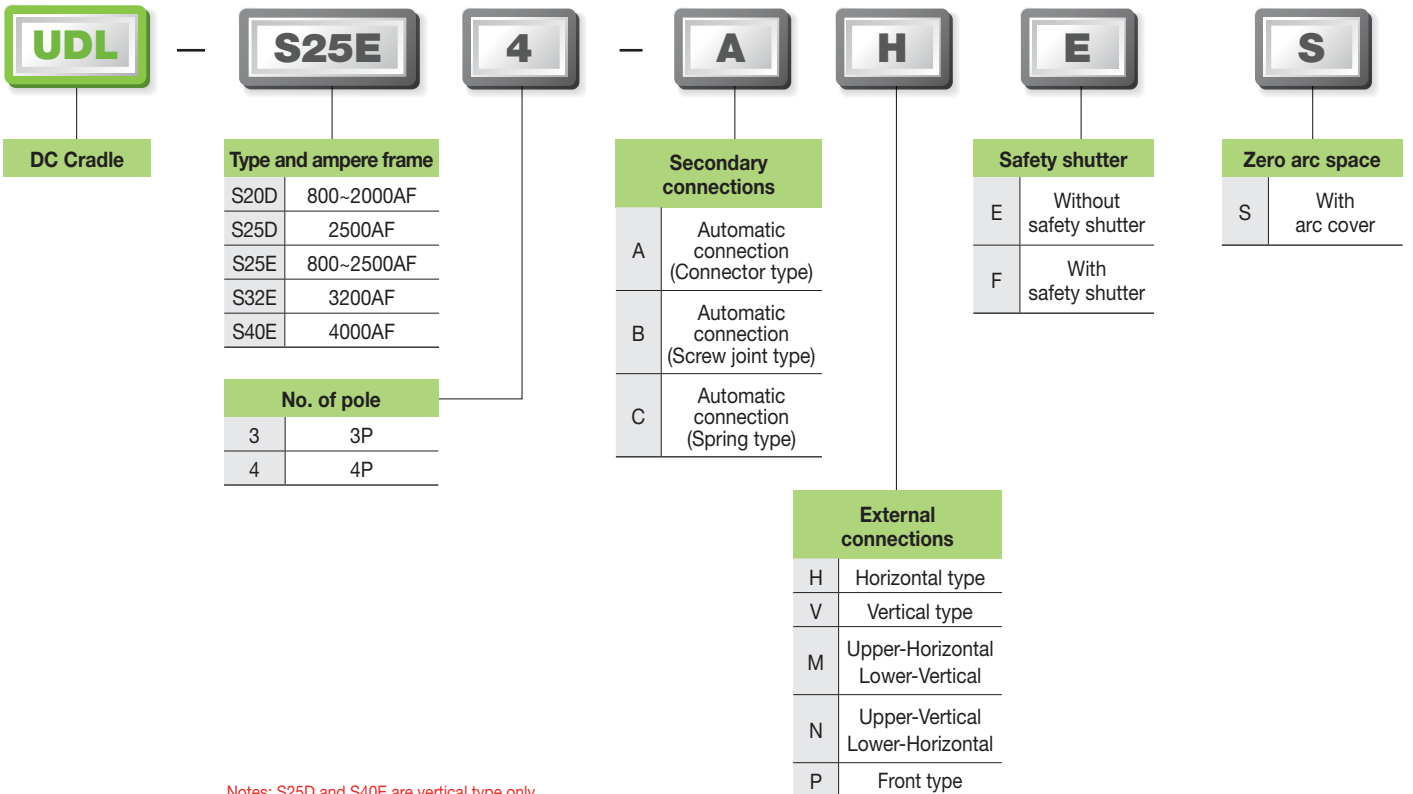

Notes: S25D and S40E are vertical type only

Accessories

UDA-40E4-00A

M1

Motor rated voltage

MA	Without motor
M1	AC/DC 100V~130V
M2	AC/DC 200V~250V
M3	DC 125V
M4	DC 24V~30V
M5	DC 48V~60V
M8	AC 48V

D1

Shunt coil rated voltage

D0	Without shunt coil
D1	AC/DC 100V~130V
D2	AC/DC 200V~250V
D3	DC 125V
D4	DC 24V~30V
D5	DC 48V~60V
D7	AC 48V

HX

Aux. contact and charging types

GX	High capacity OFF-charge 3a3b
GC	High capacity ON-charge 3a3b
HX	High capacity OFF-charge 5a5b
HC	High capacity ON-charge 5a5b
JC	High capacity ON-charge 6a6b

000

Trip relay

000	Without trip relay
-----	--------------------

U1

UVT coil rated voltage

U0	Without UVT coil
U1	AC/DC 100V~130V
U2	AC/DC 200V~250V
U3	DC 125V
U4	DC 24V~30V
U5	DC 48V~60V
U6	AC 380V~480V
U7	AC 48V

* UVT Delay module is available over AC/DC 48V

B

Closing coil rated voltage

D0	Without closing coil
D1	AC/DC 100V~130V
D2	AC/DC 200V~250V
D3	DC 125V
D4	DC 24V~30V
D5	DC 48V~60V
D7	AC 48V

Option table					
Character	Option name		Character	Option name	
S	CS2	Charge switch communication	H1	SHT2	AC/DC 100-125V
B	B	On/Off button lock	H2		AC/DC 200-250V
M	MI	Mechanical interlock	H3		DC 125V
D	DI or MOC	Door interlock or MOC (Mechanism operated cell switch)	H4		DC 24-30V
			H5		DC 48-60V
K	K1	Key lock	H6		AC 380-480V
K2	K2	Key interlock set	H7		AC 48V
K3	K3	Key lock double			
R	RCS	Ready to close switch			
T	TM	Temperature monitoring			

Ratings



Brand		Susol													
Rated nominal voltage	Vdc	DC 1250 V (4P) / DC 800 V (3P)													
Rated maximum voltage	Vdc	DC 1500 V (4P) / DC 1000 V (3P)													
Poles	(P)	4P / 3P													
Version		Fixed / Draw-out													
Standard		UL 489B, UL 489F													
Type		UDA-08D	UDA-10D	UDA-13D	UDA-16D	UDA-20D	UDA-25D	UDA-08E	UDA-16E	UDA-20E	UDA-25E	UDA-32E	UDA-40E		
Ampere frame	(AF)	800	1000	1250	1600	2000	2500	800	1600	2000	2500	3200	4000		
Short circuit withstand current	(kA)	85						100							
Operating time (ms)	Max. opening time	40ms													
	Max. closing time	80ms under													
Lift cycle (times)	Mechanical	12,500													
	Electrical	3500	2500	1500	1000	600	400	10000	8000	5000	3000	2000			
Weight lb (kg)	Draw-out type	Main body with cradle	3P	154 (70)				165 (75)	214 (97)			245 (111)	326 (148)		
			4P	187 (85)				201 (91)	269(122)			309 (140)	414 (188)		
	Only cradle	3P	71 (32)				82 (37)	99(45)			123 (56)	205 (93)			
		4P	84 (38)				97 (44)	121(55)			152 (69)	256 (116)			
	Fixed type	Motor charging type	3P	77 (35)				90 (41)	101 (46)			110 (50)	196 (89)		
			4P	99 (45)				112 (51)	126 (57)			137 (62)	249 (113)		
External dimensions Inches (mm)	Draw-out type	H×W×D	3P	16.93×13.15×16.02 (430×334×407)						16.93×16.22×16.02 (430×412×407)					
			4P	16.93×16.5×16.02 (430×419×407)						16.93×20.75×16.02 (430×527×407)					
	Fixed type	H×W×D	3P	11.81×11.81×11.61 (300×300×295)						11.81×14.88×11.61 (300×378×295)					
			4P	11.81×15.16×11.61 (300×385×295)						11.81×19.41×11.61 (300×493×295)					
Enclosure dimensions Inches (mm)	H×W×D	3P	19.69×15.75×13.39 (500×400×340)						19.69×19.69×13.39 (500×500×340)						
		4P	19.69×19.69×13.39 (500×500×340)						19.69×24.21×13.39 (500×615×340)						

Notes: 1. External dimensions do not include external terminal.
 2. UL certificate (UL489B/F) is listed on the UL site.

Connection type

Upper supply

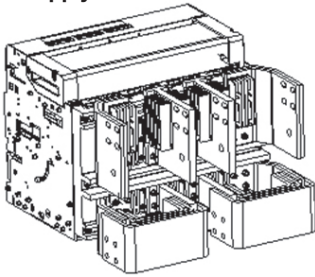

Lower supply

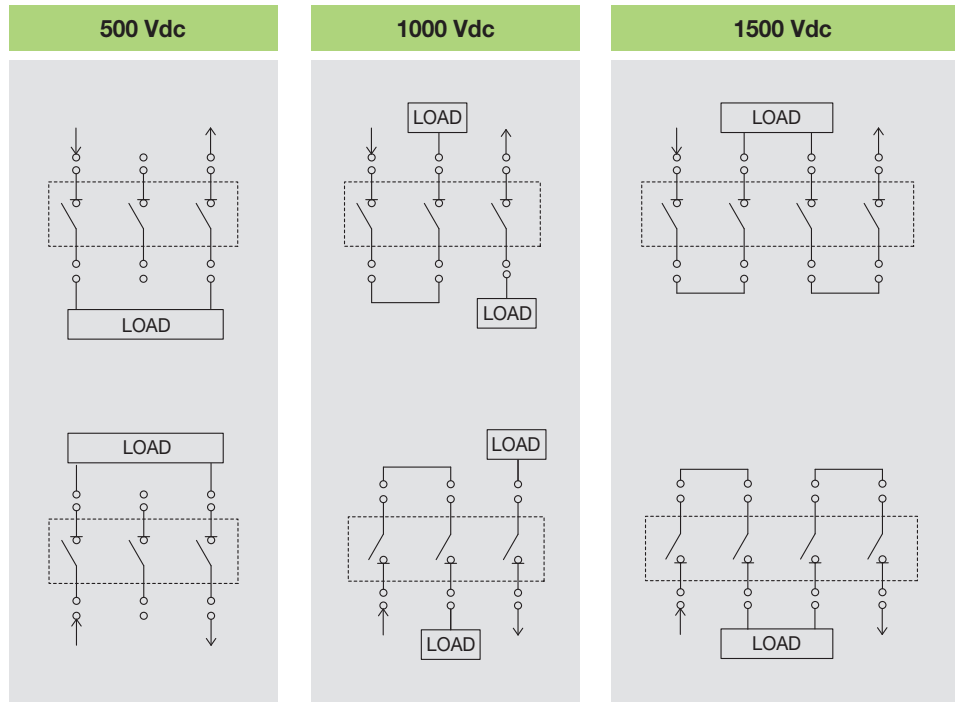
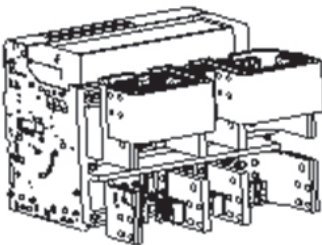

Note: For connections not found in the above instructions, ask the LS technical team.

Specification

Type	AF	Ordering number	3D configuration	Description
UDA series	D: 2000AF	70223466502 3P: 1 ea 4P: 2 ea		Short busbar: 140mm × 10T × 2ea Bolt: M12 × 55, 8ea Nut: M12, 8ea Spring washer, Plain washer, Heat sink
	D: 2500AF	70223466500 3P: 1 ea 4P: 2 ea		Short busbar: 125mm × 12T × 1ea Bolt: M12 × 45, 8ea Nut: M12, 8ea Spring washer, Plain washer, Heat sink
	E: 2500AF	70223467601 3P: 1 ea 4P: 2 ea		Short busbar: 75mm × 10T × 2ea Bolt: M12 × 50 × 4ea Nut: M12, 4ea Spring washer, Plain washer
	E: 3200AF	70223467602 3P: 1 ea 4P: 2 ea		Short busbar: 75mm × 10T × 2ea Bolt: M12 × 50 × 4ea Nut: M12, 4ea Spring washer, Plain washer
	E: 4000AF	70223467603 3P: 1 ea 4P: 2 ea		Short busbar: 125mm × 10T × 3ea Spacer busbar: 125mm × 10T × 2ea Bolt: M12 × 50 × 8ea Nut: M12, 4ea Spring washer, Plain washer

Circuit diagram

Circuit diagram (DC Switch-disconnectors)

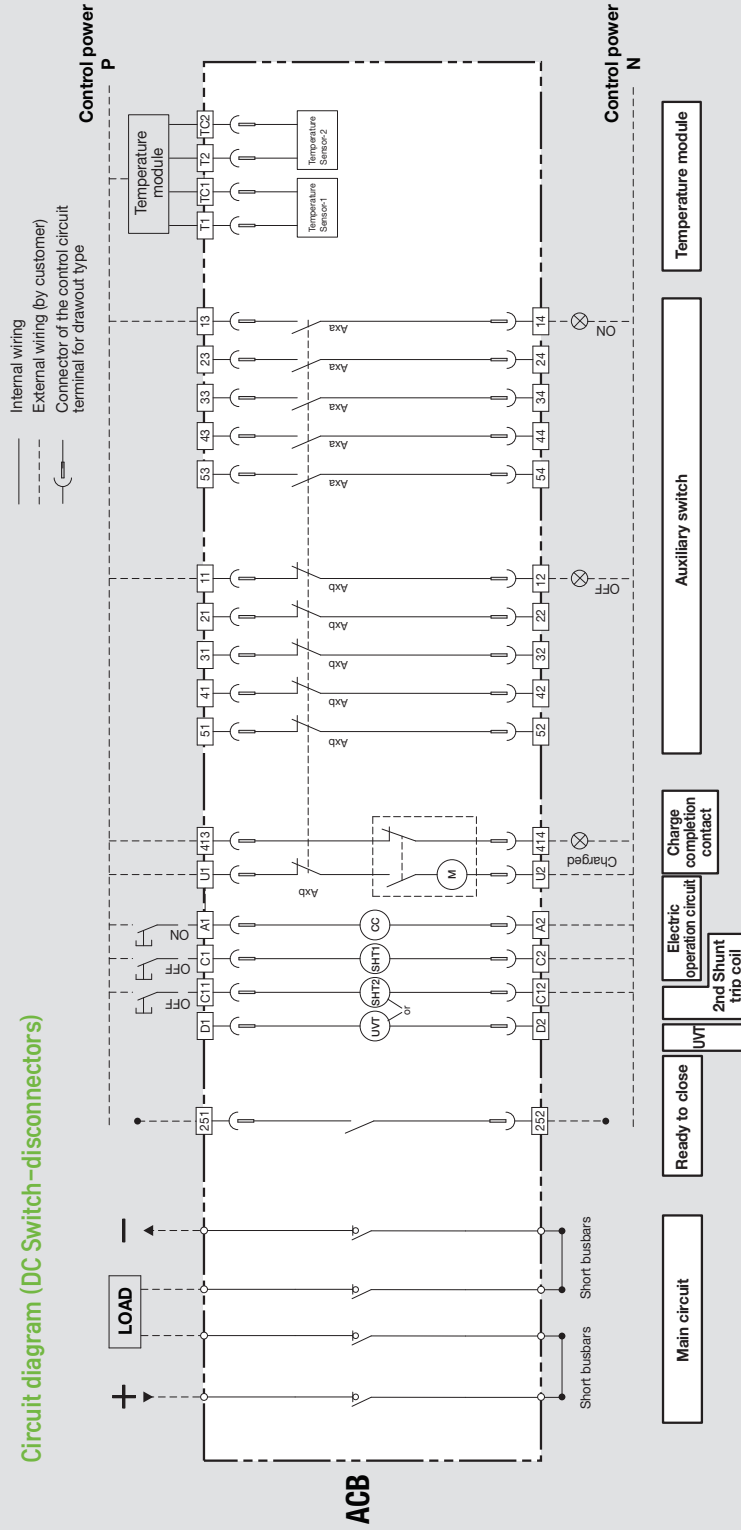

Terminal code description

13	14	~	63	64	Auxiliary switch "a"
11	12	~	61	62	Auxiliary switch "b"
413	414				Charge completion contact
U1	U2				Motor charging
A1	A2				Closing coil
C1	C2				Shunt trip
G11	C12				2nd shunt trip
D1	D2				UVT terminal
251	252				Ready to close switch

Accessory code description

Axa, Axb	Auxiliary switch
(M)	Charging motor
(CC)	Closing coil
(SH)	Shunt trip coil
(SH2)	2nd shunt trip coil
(UVT)	UVT coil

- Notes:
- The diagram is shown with circuits de-energized and all devices open, connected and charged and relays in normal position
 - Charging type is "OFF-Charging"
 - The standard of auxiliary contact is 3a3b.
 - The auxiliary switch in the diagram is 5a5b.
 - Options
 - Ready to close contact, UVT coil, charge completion contact and secondary trip coil
 - Cell switch, temperature module and remote close-open module
 - Refer to catalog for the connection of UVT
 - For connecting RS-485 and DC 24V verify if the polarity is correct
 - Contact configuration for cell switch can be changeable if necessary

Fixed type 800~2000A (UDA-08~20D)

[inch (mm)]

Front view

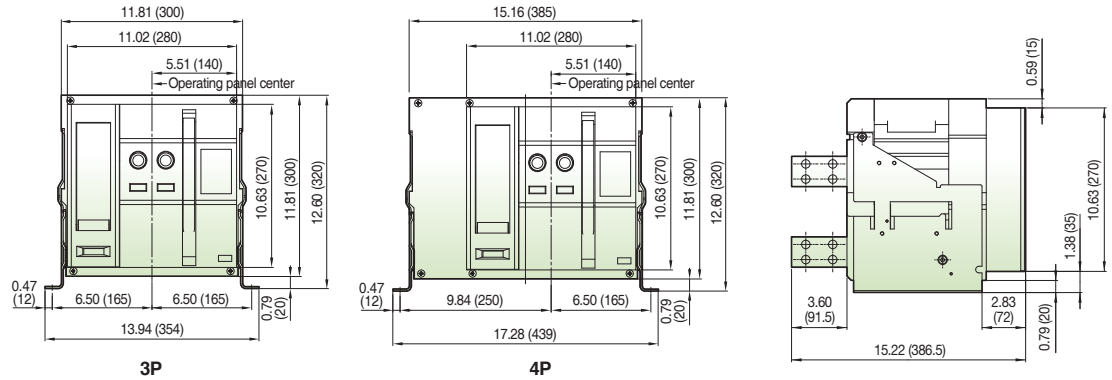

Vertical type

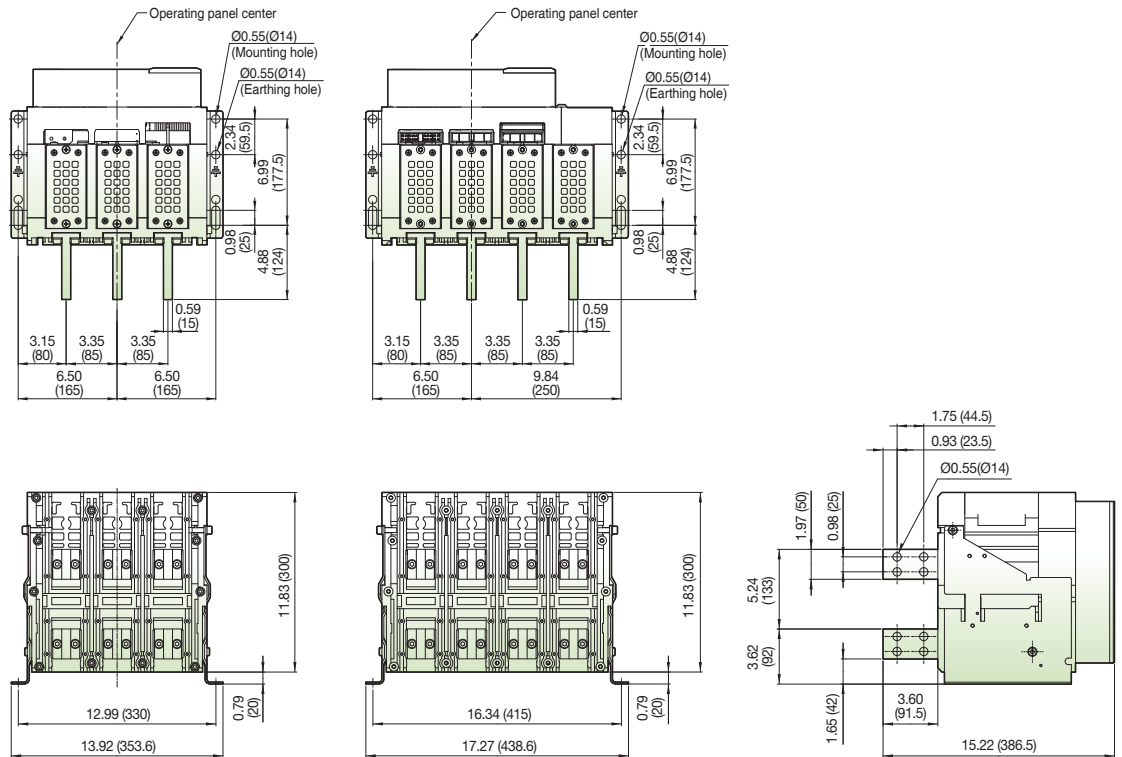

Dimensions

Fixed type 800~2000A (UDA-08~20D)

[inch (mm)]

Horizontal type

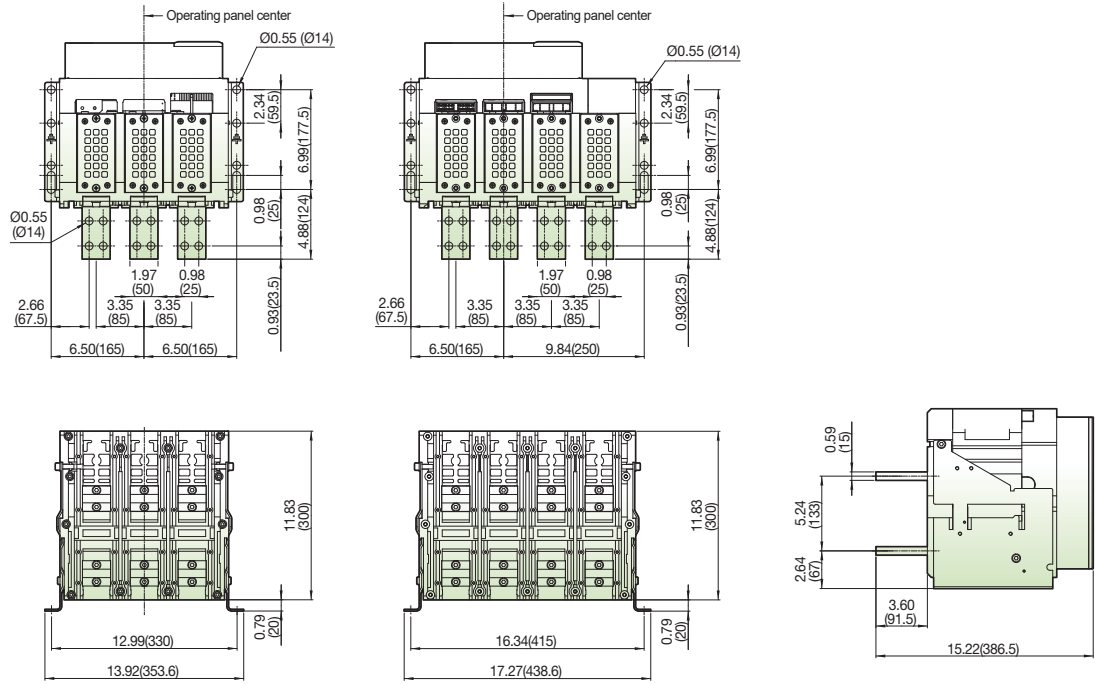

Front connection type

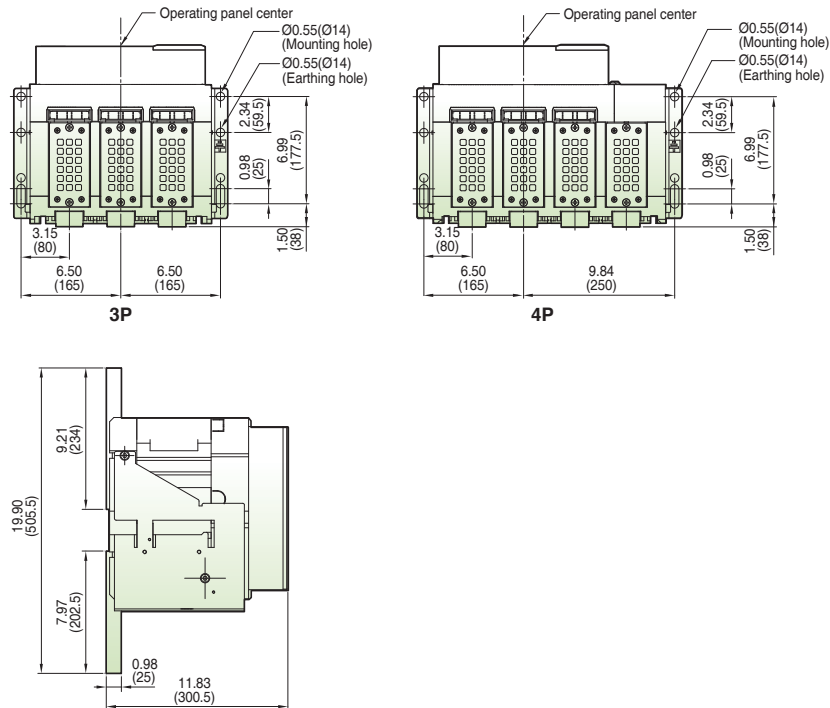

Fixed type 2500A (UDA-25D)

[inch (mm)]

Vertical type

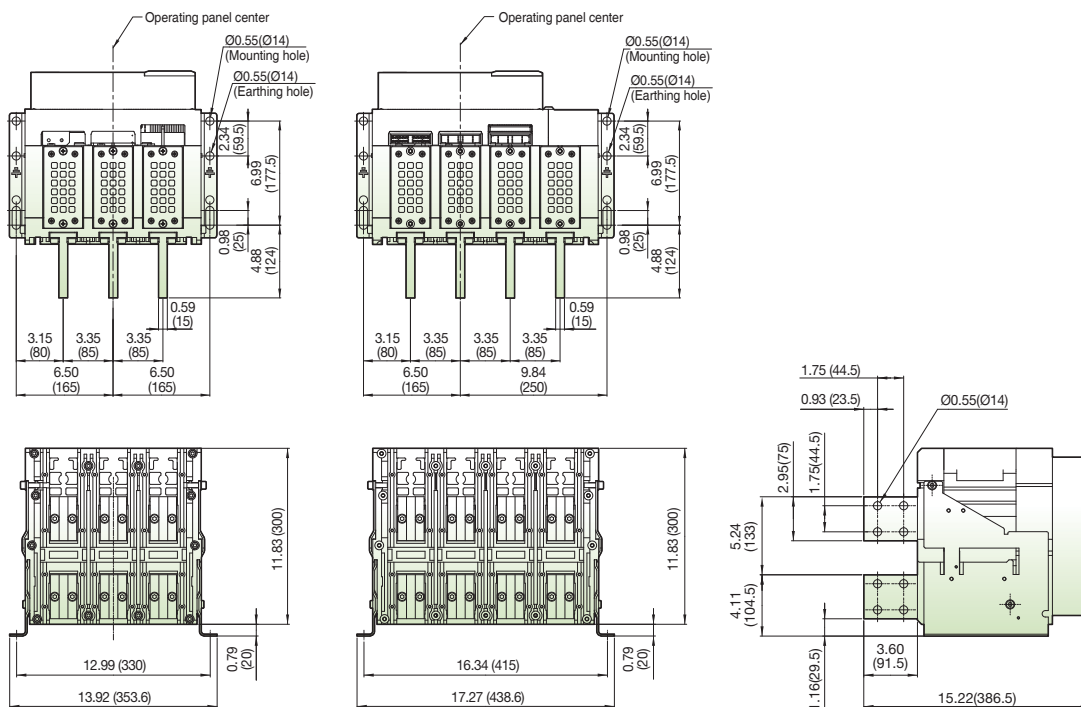

Panel front door

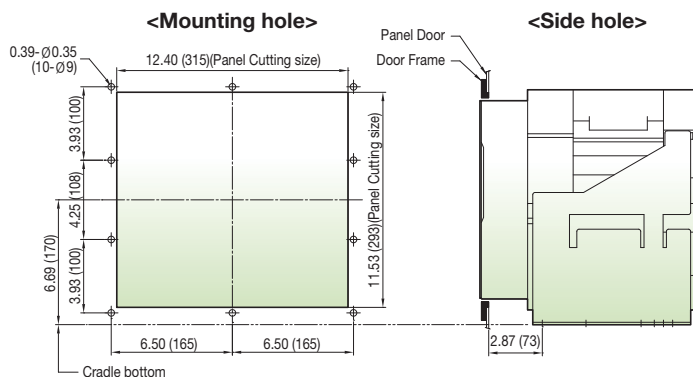

Dimensions

Draw-out type 800~2000A (UDA-08~20D)

[inch (mm)]

Front view

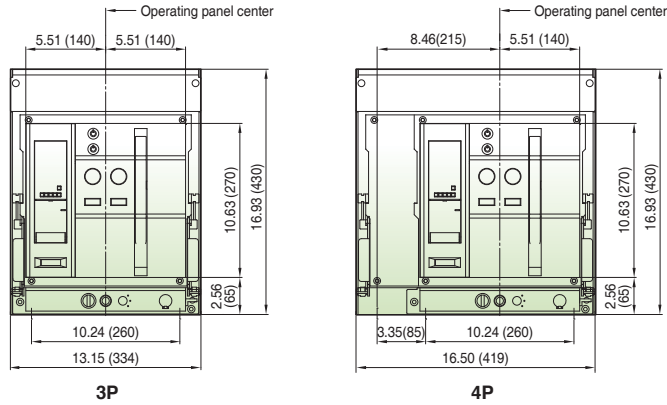

Vertical type

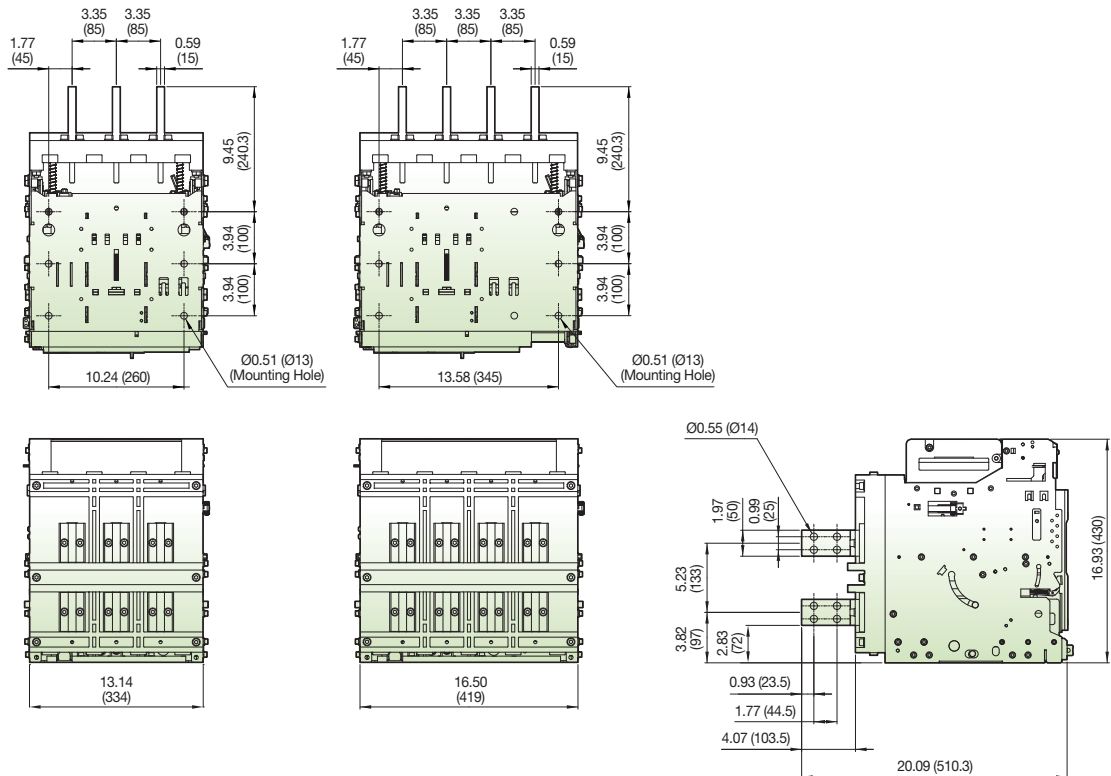

[inch (mm)]

Horizontal type

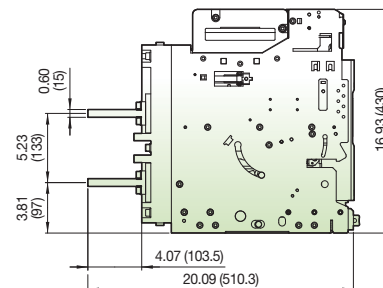
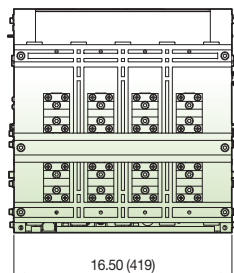
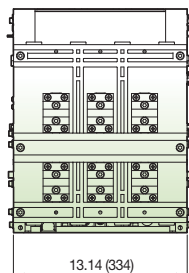
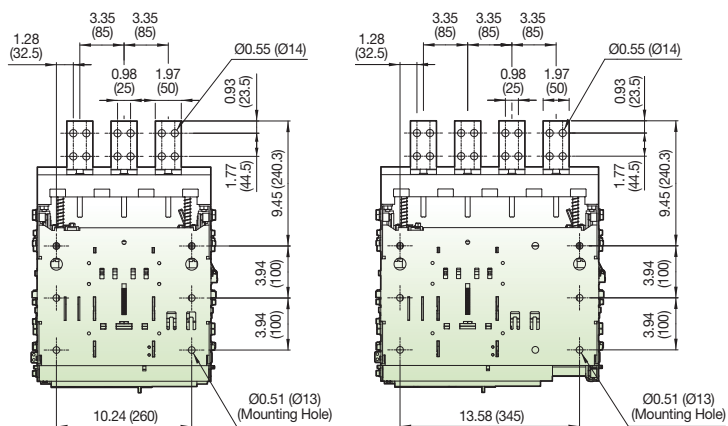

Dimensions

Draw-out type 2500A (UDA-25D)

[inch (mm)]

Vertical type

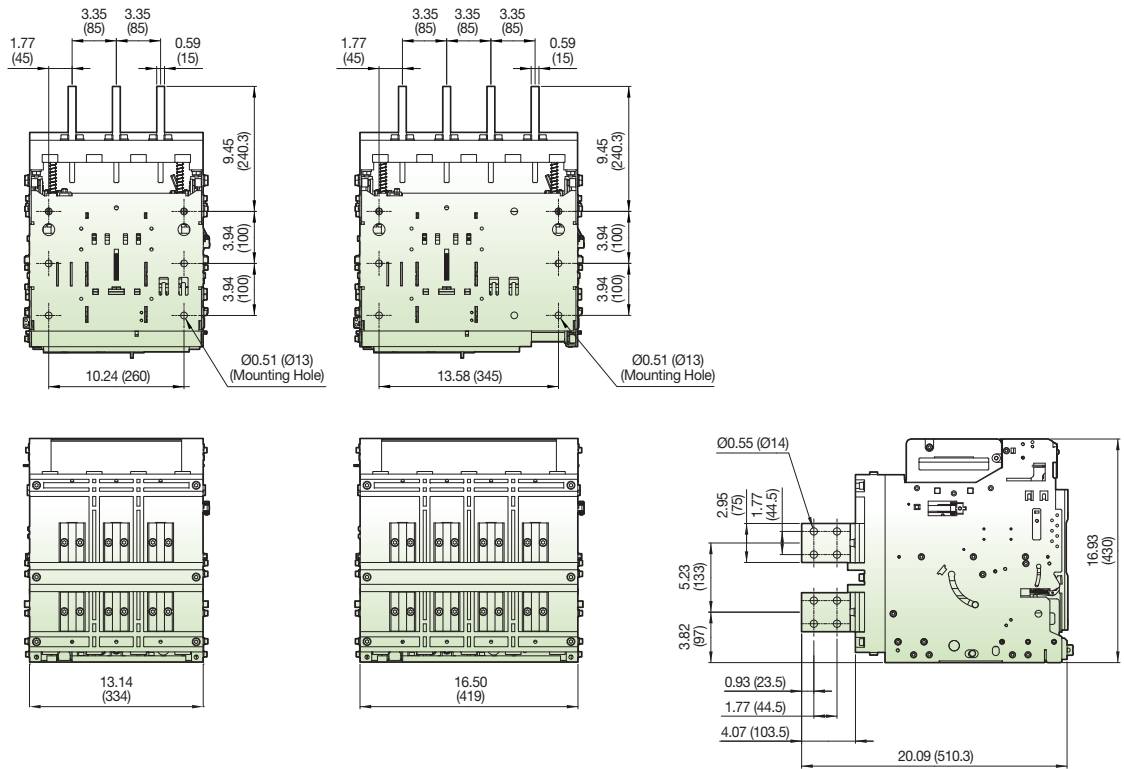

Fixed type 800~2500A (UDA-08~25E)

[inch (mm)]

Front view

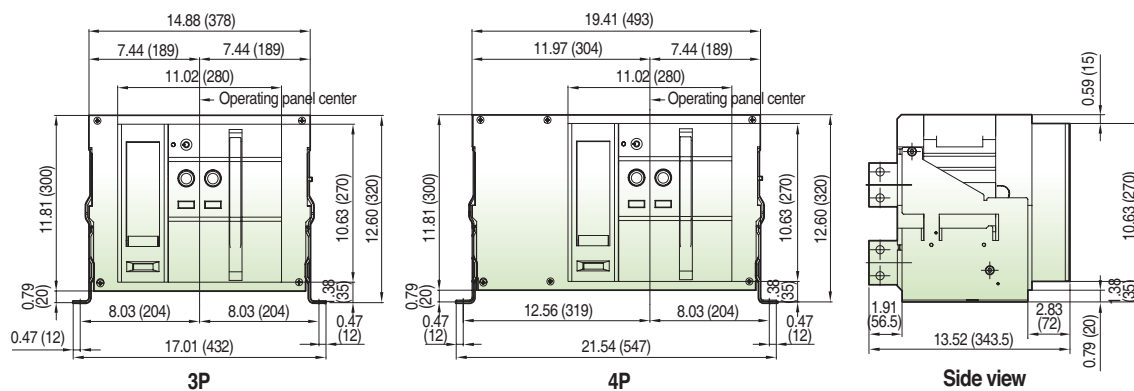

Vertical type

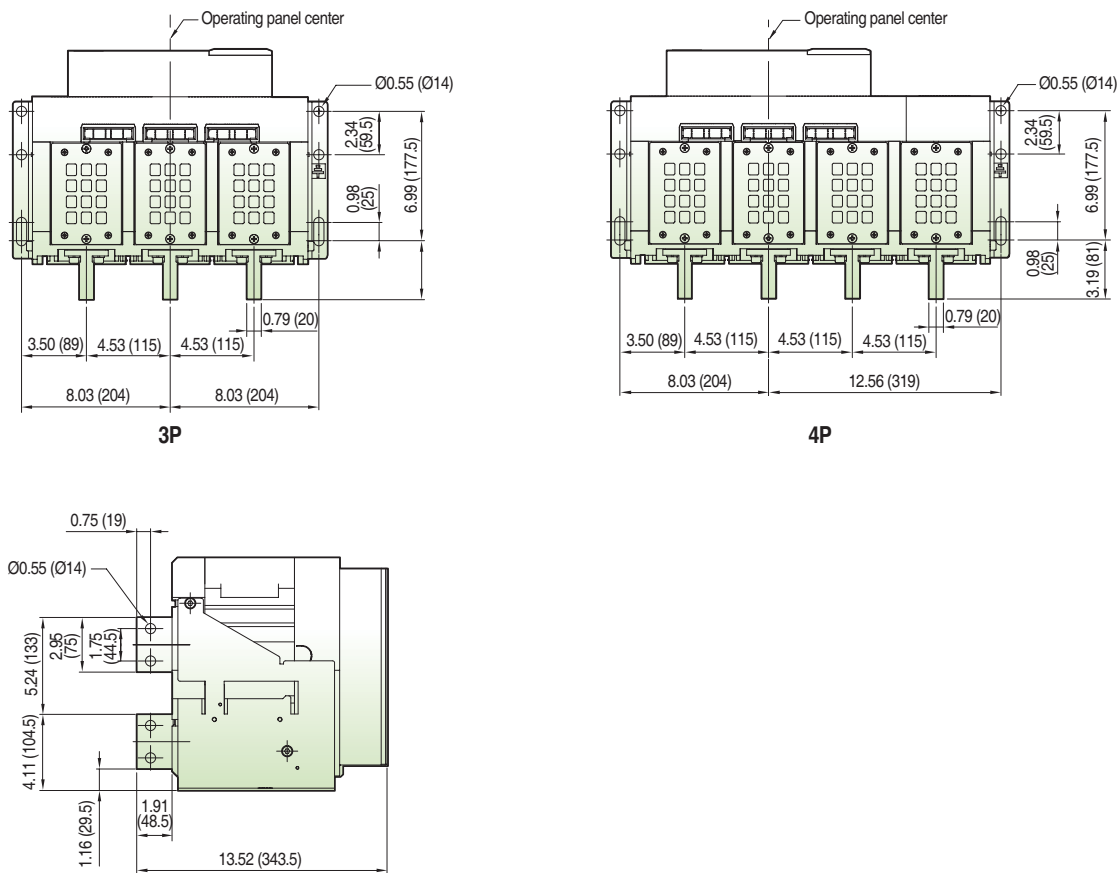

Dimensions

Fixed type 800~2500A (UDA-08~25E)

[inch (mm)]

Horizontal type

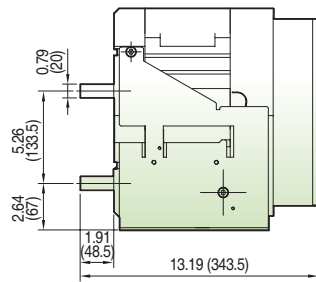
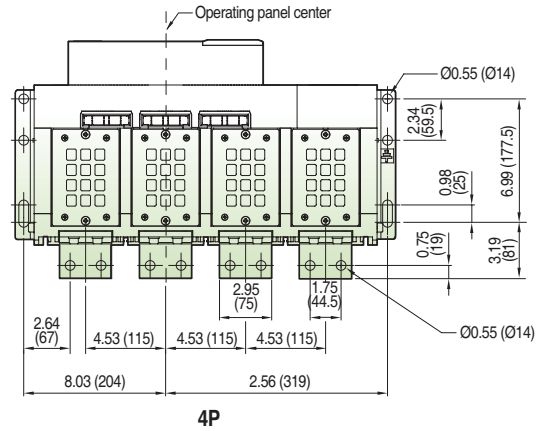
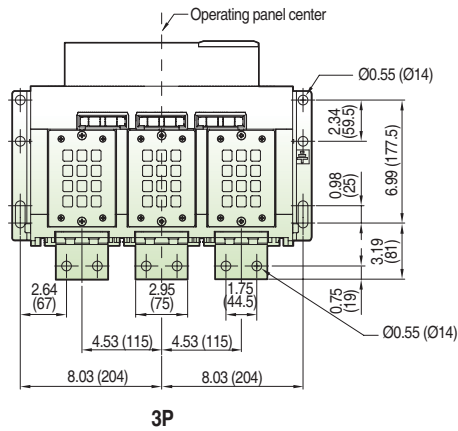

Front connection type

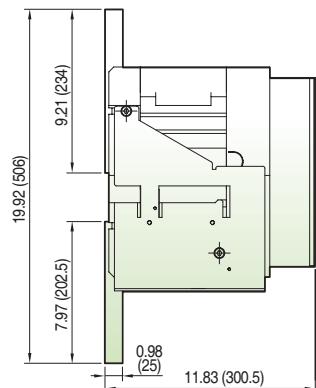
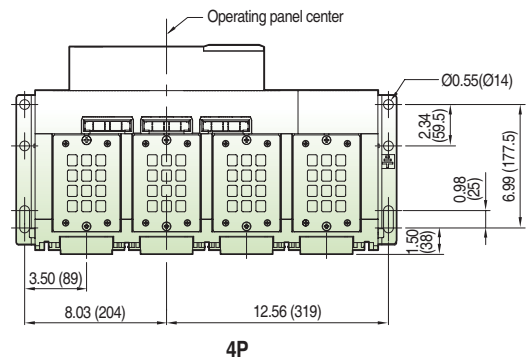
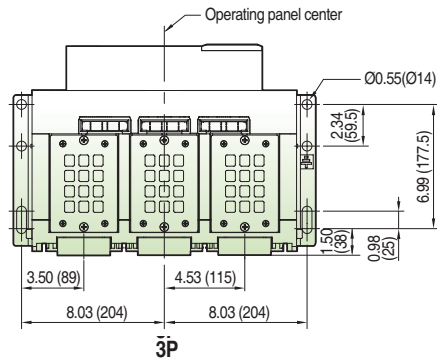

Fixed type 3200A (UDA-32E)

[inch (mm)]

Vertical type

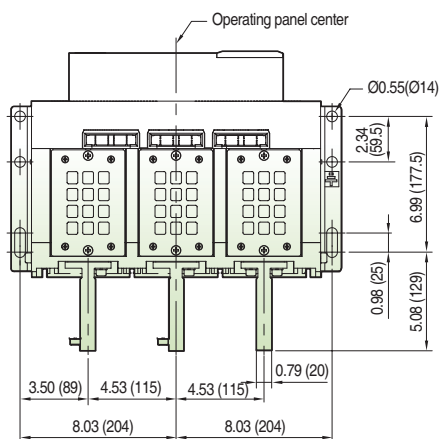

3P

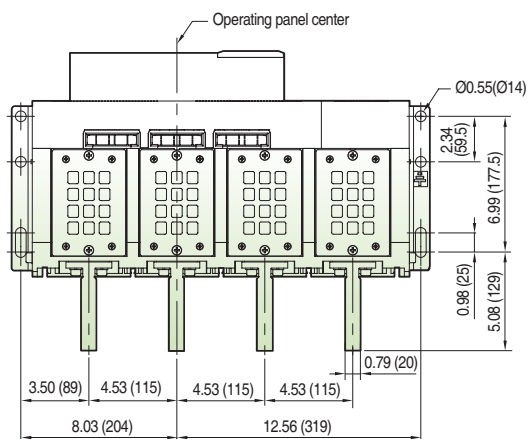

4P

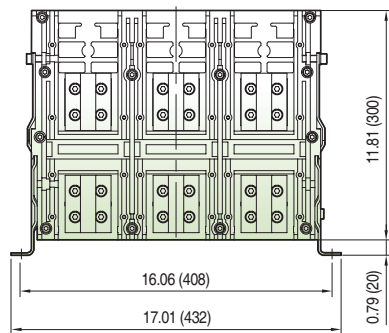

3P

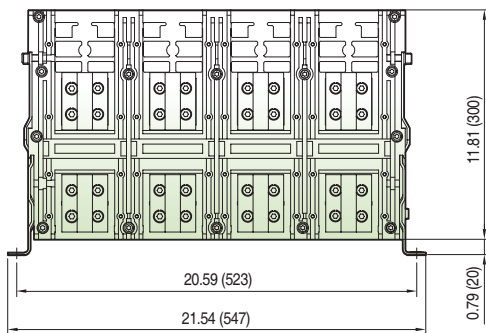

4P

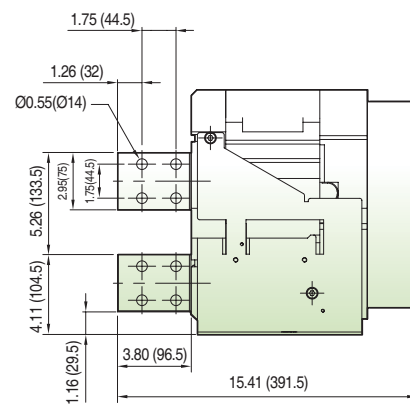

Panel front door

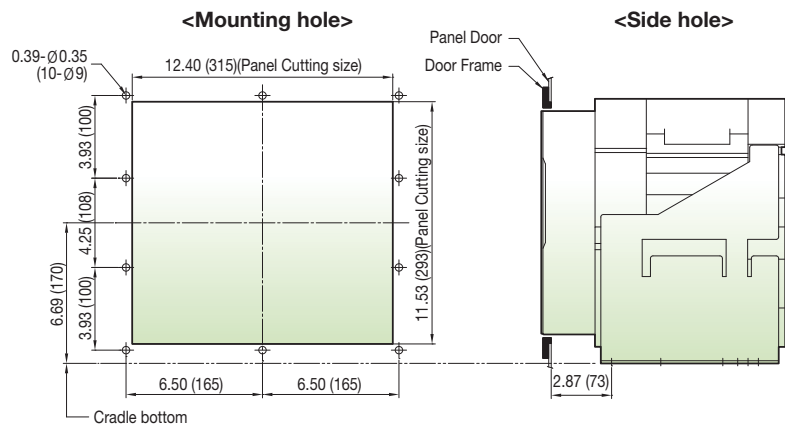

Dimensions

Fixed type 3200A (UDA-32E)

[inch (mm)]

Horizontal type

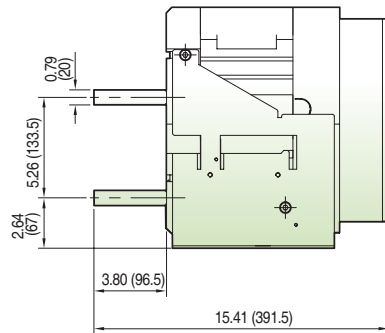
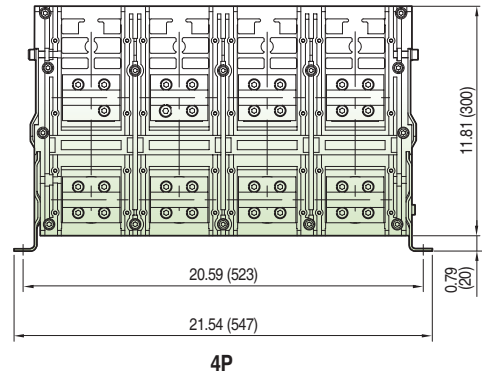
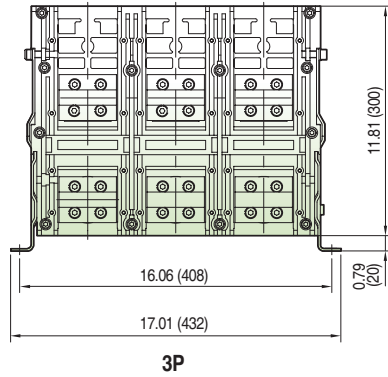
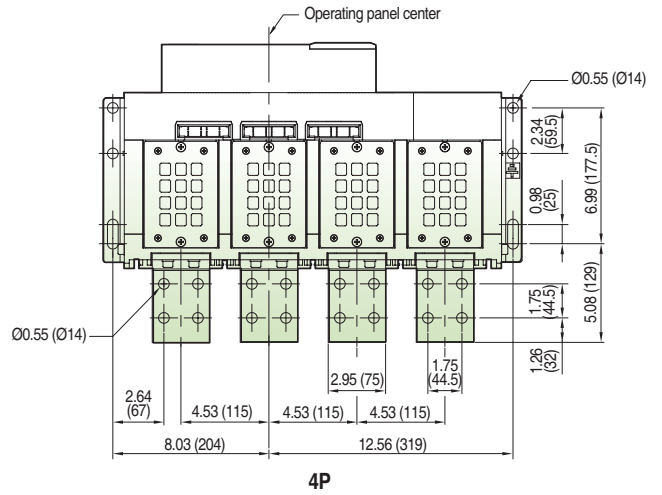
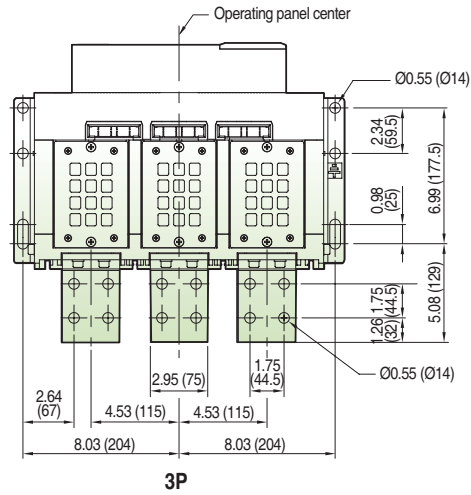

Fixed type 4000A (UDA-40E)

[inch (mm)]

Vertical type

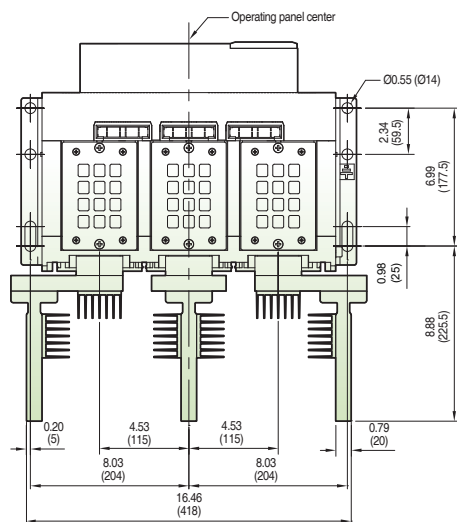

3P

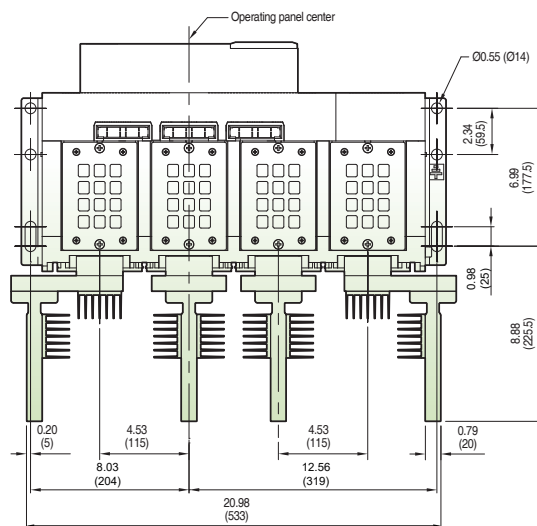

4P

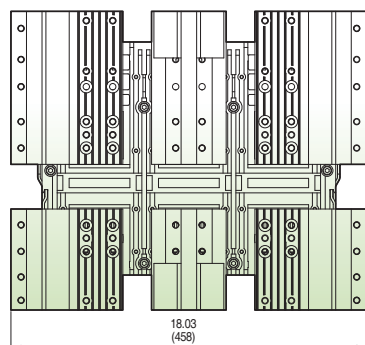

3P

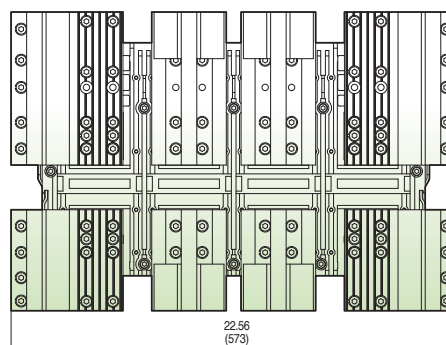

4P

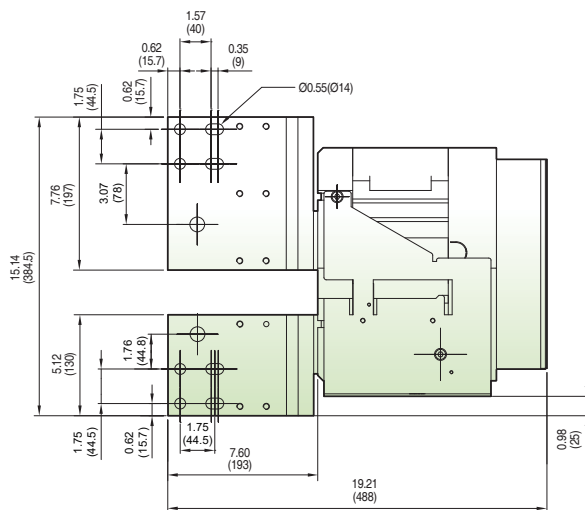

Dimensions

Draw-out type 800~2500A (UDA-08~25E)

[inch (mm)]

Front view

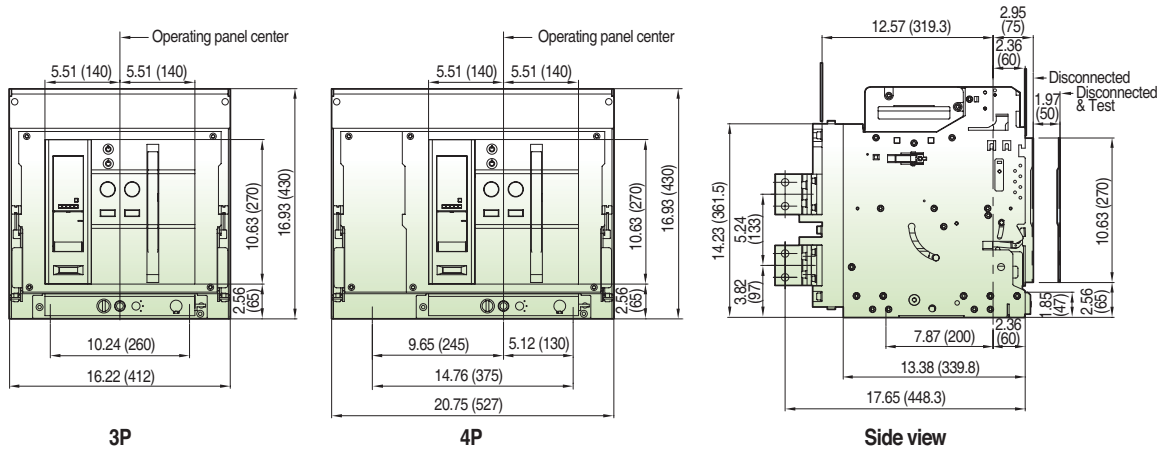

Vertical type

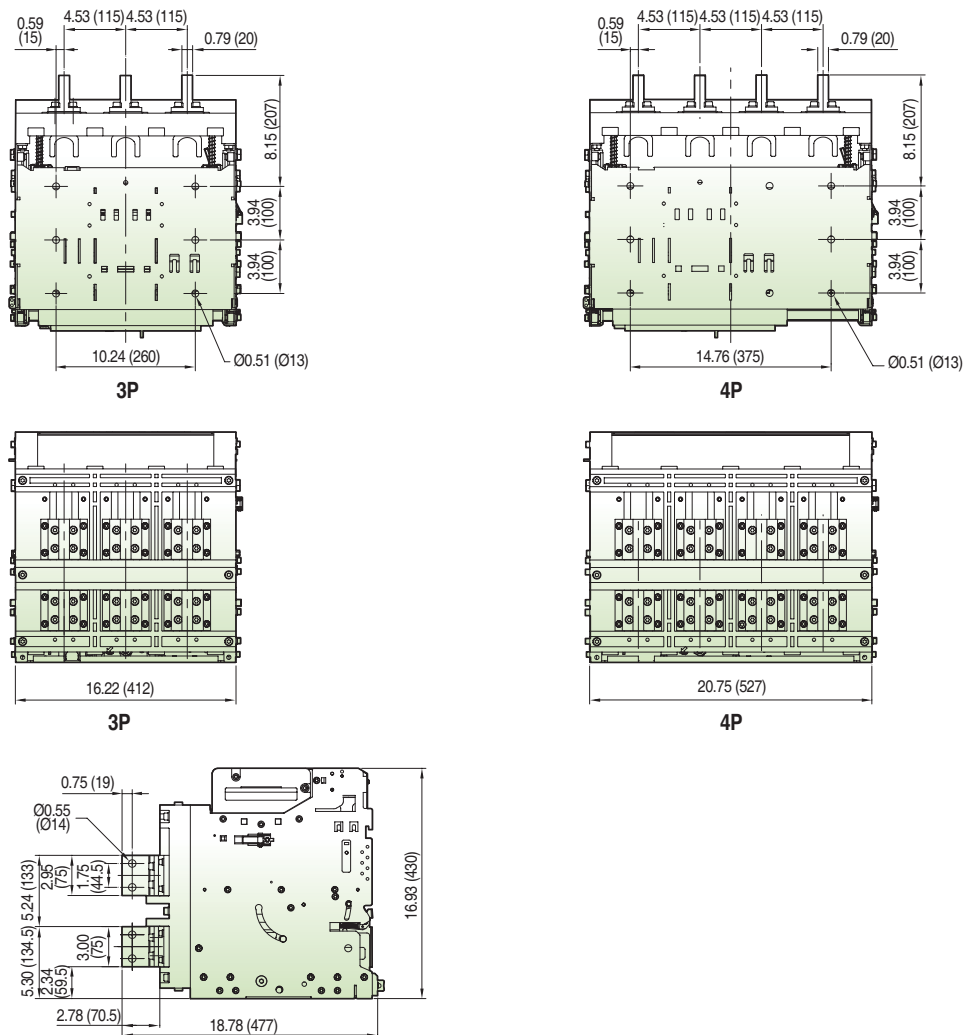

[inch (mm)]

Horizontal type

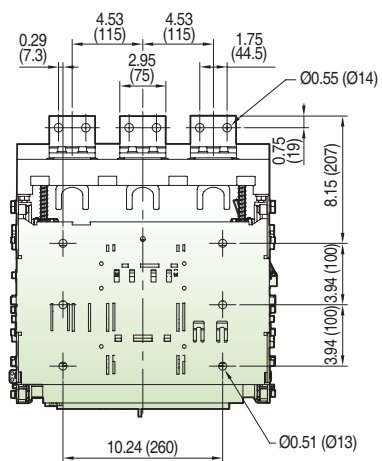

3P

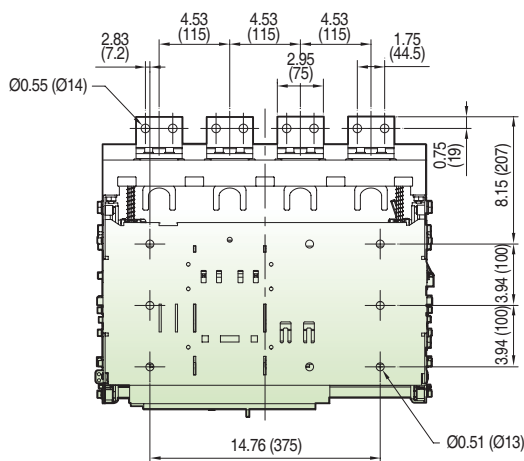

4P

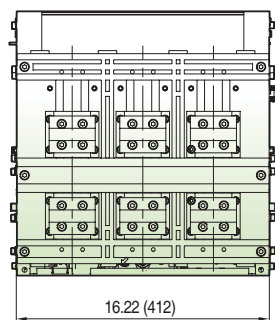

3P

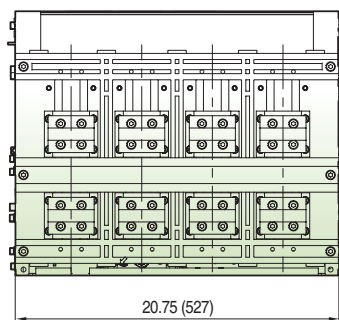

4P

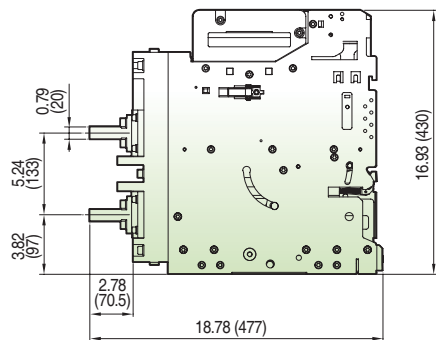

Dimensions

Draw-out type 800~2500A (UDA-08~25E)

[inch (mm)]

Front
connection
type

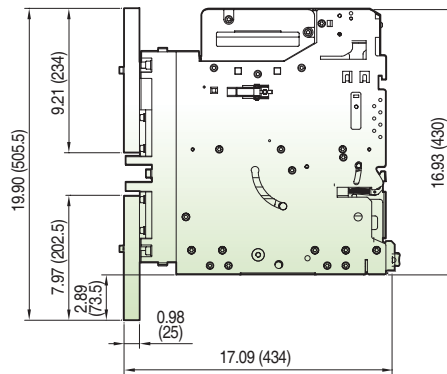
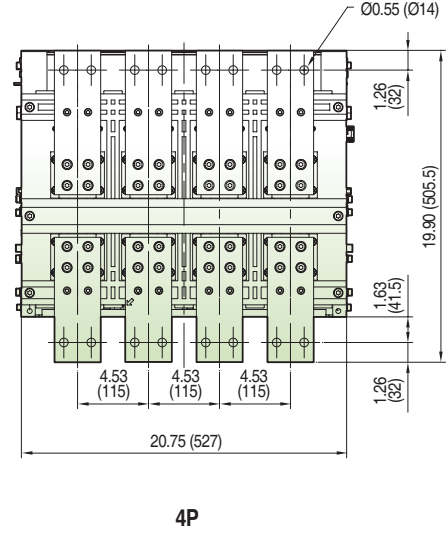
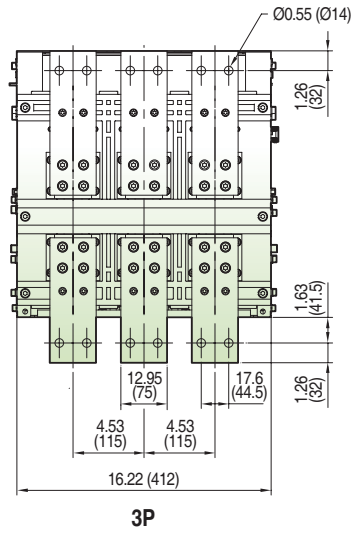
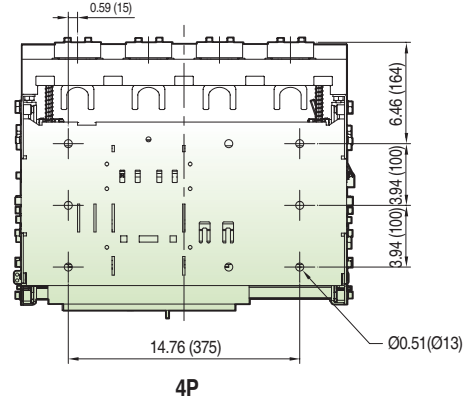
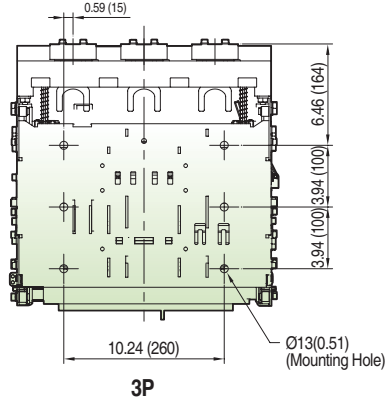

Draw-out type 3200A (UDA-32E)

[inch (mm)]

Vertical type

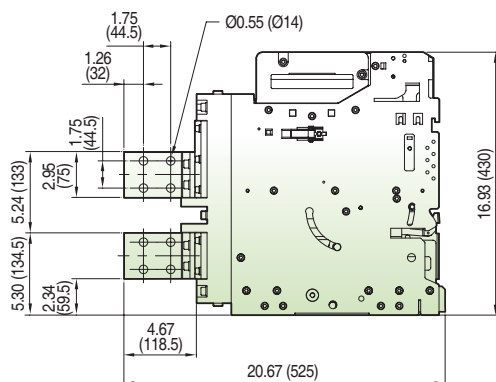
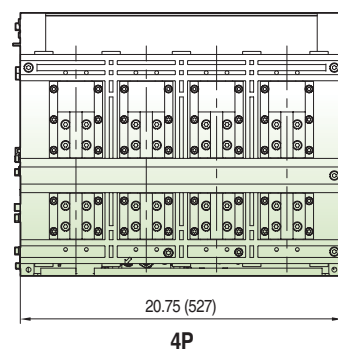
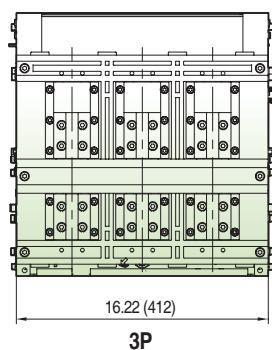
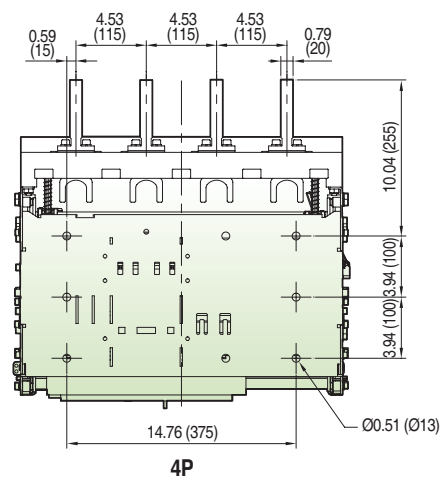
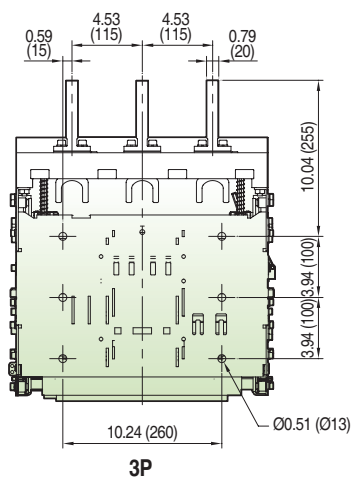

Dimensions

Draw-out type 3200A (UDA-32E)

[inch (mm)]

Horizontal type

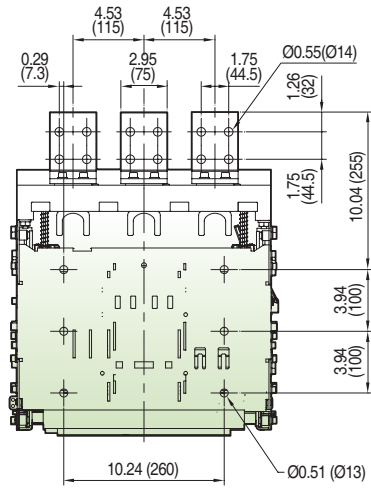

3P

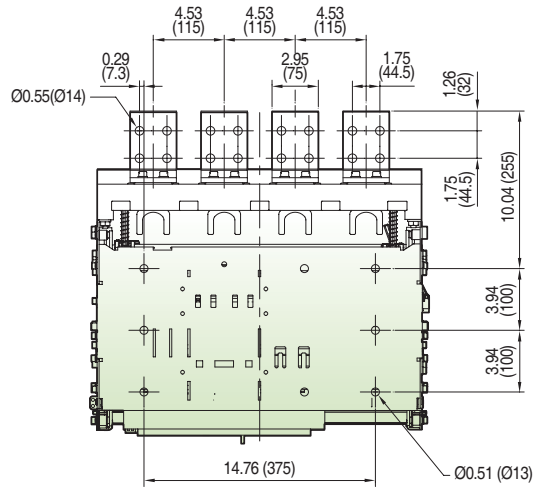

4P

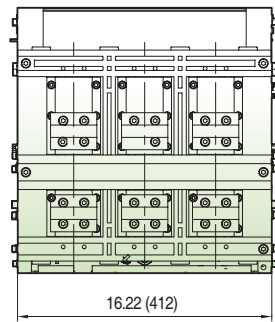

3P

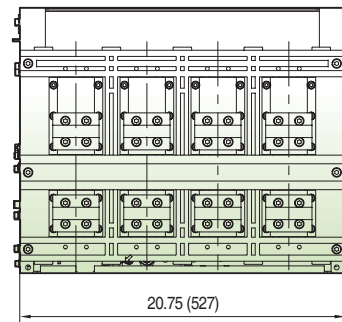

4P

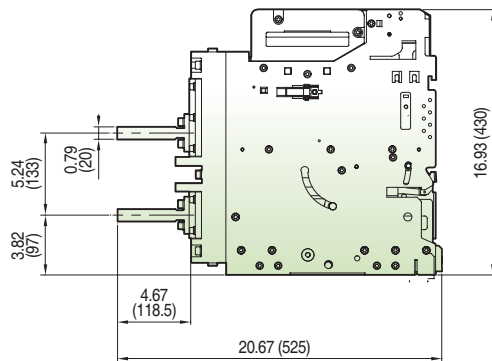

Fixed type 4000A (UDA-40E)

[inch (mm)]

Vertical type

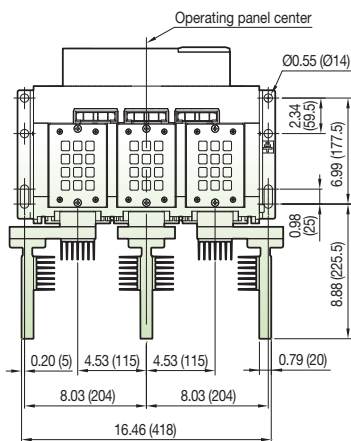

3P

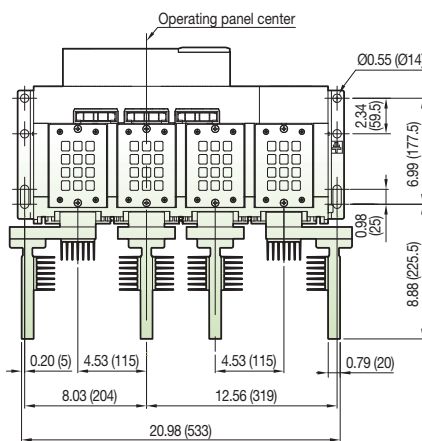

4P

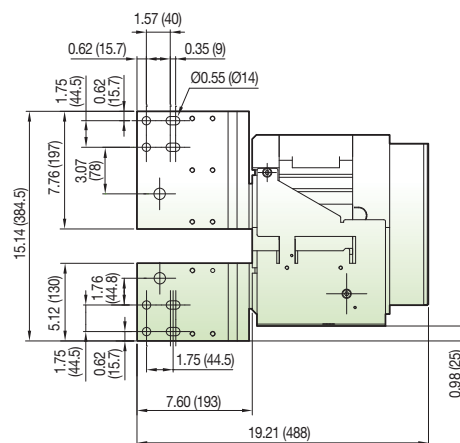
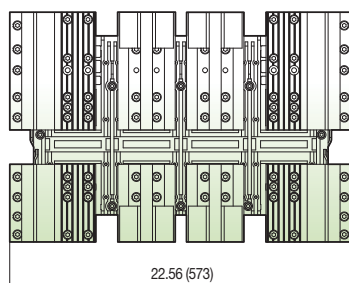
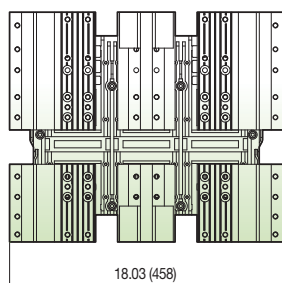

Panel front door

<Mounting hole>

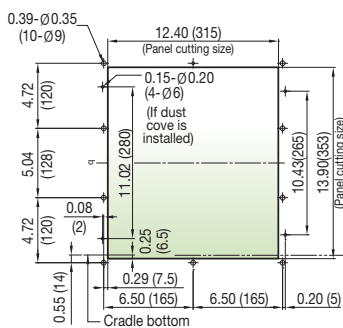

<Side hole>

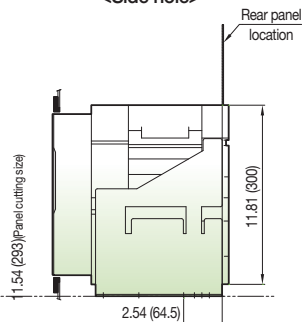

<Panel cutting (excluding P-type)>

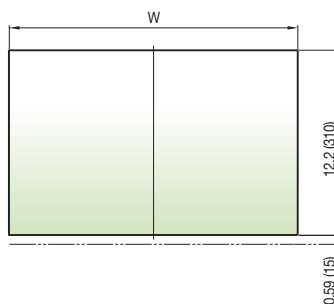



	DIM "W"
E3	15.28 (388)
E4	19.8 (503)

Note: For 4000AF, consider the distance between the terminals and any grounded metal.
 Air: 1/2 inch (12.7mm) minimum
 Surface: 1 inch (25.4mm) minimum

Temperature derating

The table below indicates the maximum current rating for each connection type, as a function of the ambient temperature around the circuit breaker and the busbars. For ambient temperatures higher than 60°C, consult us.

Product model	Rated current	Applicable busbar size (mm)															
			Horizontal type							Vertical type							
			40°C	45°C	50°C	55°C	60°C	65°C	70°C	40°C	45°C	50°C	55°C	60°C	65°C	70°C	
UDA-20D	800A	6.35T×76.2×1ea (inch: 1/4×3×1ea)	800A	800A	800A	800A	800A	800A	800A	800A	800A	800A	800A	800A	800A	800A	
		5T×100×1ea	800A	800A	800A	800A	800A	800A	800A	800A	800A	800A	800A	800A	800A	800A	
		6T×80×1ea	800A	800A	800A	800A	800A	800A	800A	800A	800A	800A	800A	800A	800A	800A	
	1000A	6.35T×50.8×2ea (inch: 1/4×2×2ea)	1000A	1000A	1000A	1000A	1000A	690A	912A	1000A	1000A	1000A	1000A	1000A	1000A	1000A	
		6T×50×2ea	1000A	1000A	1000A	1000A	1000A	690A	912A	1000A	1000A	1000A	1000A	1000A	1000A	1000A	
		10T×60×1ea	1000A	1000A	1000A	1000A	1000A	690A	912A	1000A	1000A	1000A	1000A	1000A	1000A	1000A	
	1250A	6.35T×57.2×2ea (inch: 1/4×2' 1/4×2ea)	1250A	1250A	1188A	1165A	1110A	1063A	1013A	1250A	1250A	1250A	1250A	1250A	1250A	1250A	
		10T×100×1ea	1250A	1250A	1188A	1165A	1110A	1063A	1013A	1250A	1250A	1250A	1250A	1250A	1250A	1250A	
	1600A	6.35T×76.2×2ea (inch: 1/4×3×2ea)	1600A	1600A	1493A	1432A	1368A	1310A	1250A	1600A	1600A	1600A	1600A	1552A	1488A	1424A	
		10T×100×1ea	1600A	1600A	1493A	1432A	1368A	1310A	1250A	1600A	1600A	1600A	1600A	1552A	1488A	1424A	
		6T×80×2ea	1600A	1600A	1493A	1432A	1368A	1310A	1250A	1600A	1600A	1600A	1600A	1552A	1488A	1424A	
	2000A	6.35T×101.6×2ea (inch: 1/4×4×2ea)	2000A	2000A	1866A	1790A	1710A	1638A	1562A	2000A	2000A	1968A	1904A	1840A	1762A	1680A	
5T×125×2ea		2000A	2000A	1866A	1790A	1710A	1638A	1562A	2000A	2000A	1968A	1904A	1840A	1762A	1680A		
8T×80×2ea		2000A	2000A	1866A	1790A	1710A	1638A	1562A	2000A	2000A	1968A	1904A	1840A	1762A	1680A		
UDA-25D	2500A	6.35T×127×2ea (inch: 1/4×5×2ea)	-	-	-	-	-	-	-	-	2500A	2500A	2460A	2380A	2300A	2203A	2100A
		8T×100×2ea	-	-	-	-	-	-	-	-	2500A	2500A	2460A	2380A	2300A	2203A	2100A
		5T×100×3ea	-	-	-	-	-	-	-	-	2500A	2500A	2460A	2380A	2300A	2203A	2100A
		10T×80×2ea	-	-	-	-	-	-	-	-	2500A	2500A	2460A	2380A	2300A	2203A	2100A
UDA-25E	800A	6.35T×76.2×1ea (inch: 1/4×3×1ea)	800A	800A	800A	800A	800A	800A	800A	800A	800A	800A	800A	800A	800A	800A	
		5T×100×1ea	800A	800A	800A	800A	800A	800A	800A	800A	800A	800A	800A	800A	800A	800A	
		6T×80×1ea	800A	800A	800A	800A	800A	800A	800A	800A	800A	800A	800A	800A	800A	800A	
	1600A	6.35T×76.2×2ea (inch: 1/4×3×2ea)	1600A	1600A	1600A	1600A	1600A	1600A	1600A	1600A	1600A	1600A	1600A	1600A	1600A	1600A	
		10T×100×1ea	1600A	1600A	1600A	1600A	1600A	1600A	1600A	1600A	1600A	1600A	1600A	1600A	1600A	1600A	
		6T×80×2ea	1600A	1600A	1600A	1600A	1600A	1600A	1600A	1600A	1600A	1600A	1600A	1600A	1600A	1600A	
	2000A	6.35T×101.6×2ea (inch: 1/4×4×2ea)	-	-	-	-	-	-	-	-	2000A	2000A	2000A	2000A	2000A	2000A	1871A
		5T×125×2ea	-	-	-	-	-	-	-	-	2000A	2000A	2000A	2000A	2000A	2000A	1871A
		8T×80×2ea	2000A	2000A	2000A	2000A	2000A	1886A	1764A	2000A	2000A	2000A	2000A	2000A	2000A	2000A	1871A
	2500A	6.35T×127×2ea (inch: 1/4×5×2ea)	-	-	-	-	-	-	-	-	2500A	2500A	2500A	2500A	2400A	2263A	2117A
		8T×100×2ea	-	-	-	-	-	-	-	-	2500A	2500A	2500A	2500A	2400A	2263A	2117A
		5T×100×3ea	2500A	2500A	2500A	2400A	2300A	2168A	2028A	2500A	2500A	2500A	2500A	2400A	2263A	2117A	
10T×80×2ea		2500A	2500A	2500A	2400A	2300A	2168A	2028A	2500A	2500A	2500A	2500A	2400A	2263A	2117A		
UDA-32E	3200A	6.35T×127×3ea (inch: 1/4×5×3ea)	-	-	-	-	-	-	-	-	3200A	3200A	3200A	3120A	3050A	2876A	2690A
		10T×125×2ea	-	-	-	-	-	-	-	-	3200A	3200A	3200A	3120A	3050A	2876A	2690A
		10T×80×3ea	-	-	-	-	-	-	-	-	3200A	3200A	3200A	3120A	3050A	2876A	2690A
		8T×100×3ea	3200A	3200A	3100A	3000A	2900A	2734A	2557A	3200A	3200A	3200A	3200A	3120A	3050A	2876A	2690A
UDA-40E	4000A	6.35T×127×4ea (inch: 1/4×5×4ea)	-	-	-	-	-	-	-	-	4000A	4000A	4000A	3950A	3800A	3583A	3351A
		10T×125×3ea	-	-	-	-	-	-	-	-	4000A	4000A	4000A	3950A	3800A	3583A	3351A

* If ambient temperature is higher than 60°C, consult us. * Current values higher than 60°C are based on ANSI standard.
 * Total temperature limit is 105°C according to UL standard.

Technical information

Operating conditions

Ambient temperature

DC Products can operate under the following temperature conditions:

- The electrical and mechanical characteristics are stipulated for an ambient temperature of -20°C to +60°C
- The average temperature should be within + 35°C
- Reduce the continuous conducting current when the temperature is over 45°C (refer to temperature derating)
- Storage condition: -40°C to +80°C is recommended

Altitude

DC Products are designed for operation at altitudes under 2000m.

At altitudes higher than 2000m, change the ratings based on service condition.

Item	Altitude [m]			
	2000	3000	4000	5000
Maximum rated voltage	1500 Vdc	1350 Vdc	1200 Vdc	1050 Vdc
	1000 Vdc	900 Vdc	800 Vdc	700 Vdc
	750 Vdc	675 Vdc	600 Vdc	525 Vdc
Current compensation constant	1 × I _n	0.98 × I _n	0.96 × I _n	0.94 × I _n

Environment

Clean air: Maximum temperature + 40°C (relative humidity should be under 85%)

Maximum temperature + 20°C (relative humidity should be under 90%)

Do not install in locations with corrosive or ammonia gas (H₂S ≤ 0.01ppm, SO₂ ≤ 0.01ppm, NH₃ ≤ a few ppm)

Extreme atmosphere conditions

Under high temperature and/or high humidity, insulation durability, as well as electrical and mechanical features could deteriorate. At these conditions, increase corrosion-resistant features and capabilities. Corrosion-resistant parts are required under these conditions.

Internal resistance and power consumption

Type	Pole	Rated current (A)	Fixed type		Draw-out type	
			Resistance (mΩ)	Power dissipation (W)	Resistance (mΩ)	Power dissipation (W)
UDA-20D	3P	800	0.081	52	0.104	67
		1,000	0.081	81	0.104	104
		1,250	0.081	127	0.104	163
		1,600	0.081	207	0.104	266
		2,000	0.081	324	0.104	416
UDA-25D		2,500	0.070	438	0.093	581
UDA-20D	4P	800	0.110	70	0.140	90
		1,000	0.110	110	0.140	140
		1,250	0.110	172	0.140	219
		1,600	0.110	282	0.140	358
		2,000	0.110	440	0.140	560
UDA-25D		2,500	0.100	625	0.130	813
UDA-25E	3P	800	0.031	20	0.061	39
		1,600	0.031	79	0.061	156
		2,000	0.031	124	0.061	244
		2,500	0.031	194	0.061	381
UDA-32E		3,200	0.028	287	0.046	471
UDA-40E		4,000	0.025	400	0.040	640
UDA-25E	4P	800	0.042	27	0.082	52
		1,600	0.042	108	0.082	210
		2,000	0.042	168	0.082	328
		2,500	0.042	263	0.082	513
		UDA-32E		3,200	0.038	389
UDA-40E		4,000	0.034	544	0.054	864

Notes: 1. Power dissipation is the value measured at each rated current for 3-pole or 4-pole breaker.

2. Resistance is the value measured across the terminals when connecting all poles in series.

Installation recommendation

Insulation clearance

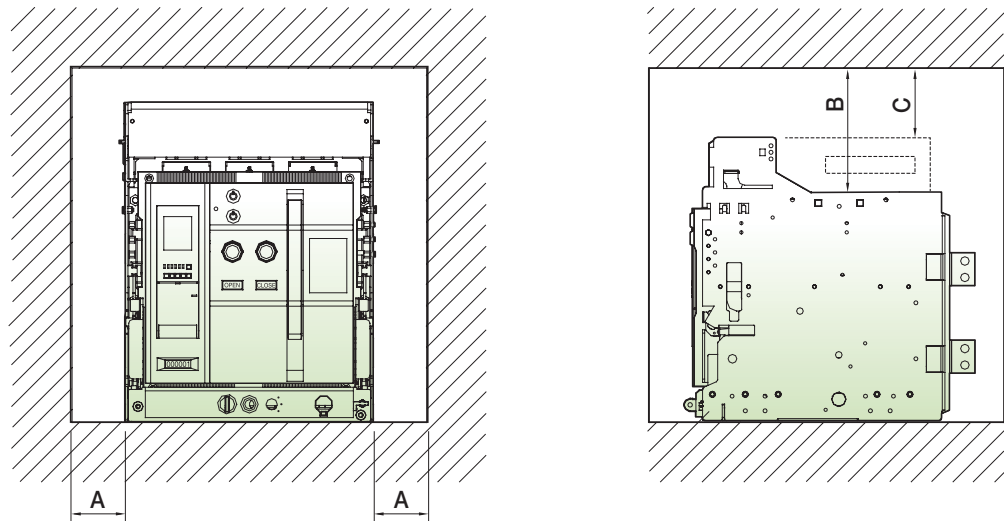

Type	A	B	C
Fixed	50	150	N/A
Drawout	5	N/A	0

Minimum spacing

The dimensions of all charging parts should be over the minimum spacing.

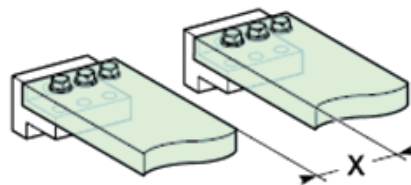

Voltage between parts	Minimum spacing at terminals (air)	
	Between terminals of opposite polarity (X)	Between terminals and any grounded metal
131 ~ 300V	19.1mm	12.7mm
301 ~ 1000V (or 1500Vdc)	25.4mm	12.7mm

Technical information

BUS-BAR Connection

Cables connections

Make sure that no excessive mechanical force is placed on the rear terminals for cable connection. The extension terminal is fixed, such as B and C, and the cable should be fixed to the frame, such as E.

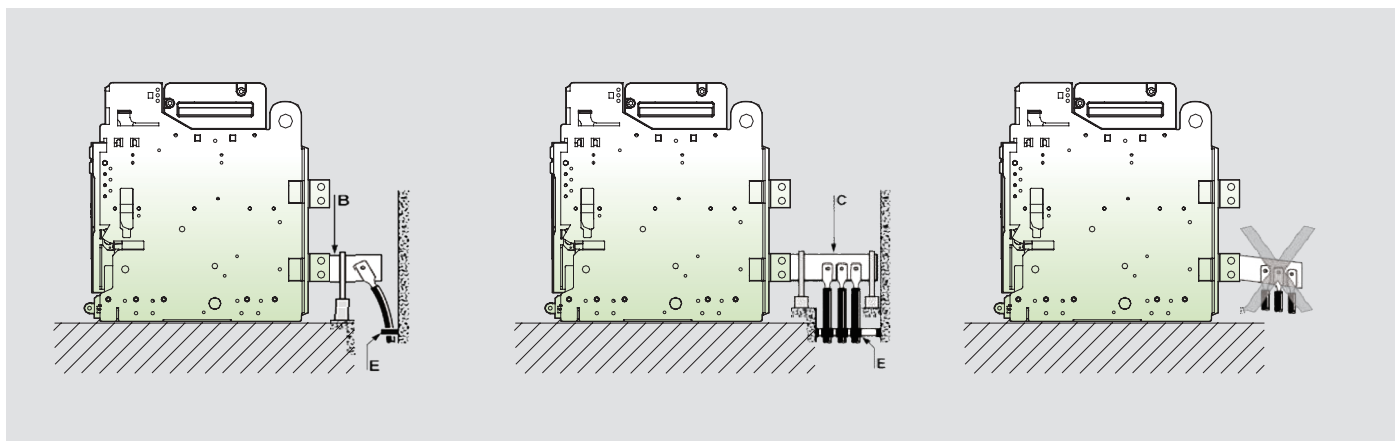

Bus-bar connection

For busbar connection, connect access parts with provided torque and fix in parallel installing the support. Do not apply terminal weight to the circuit breaker during installation.

To prevent accidents, observe the maximum safe distance A (Table 1) from the access area to withstand electrical force during short circuit faults.

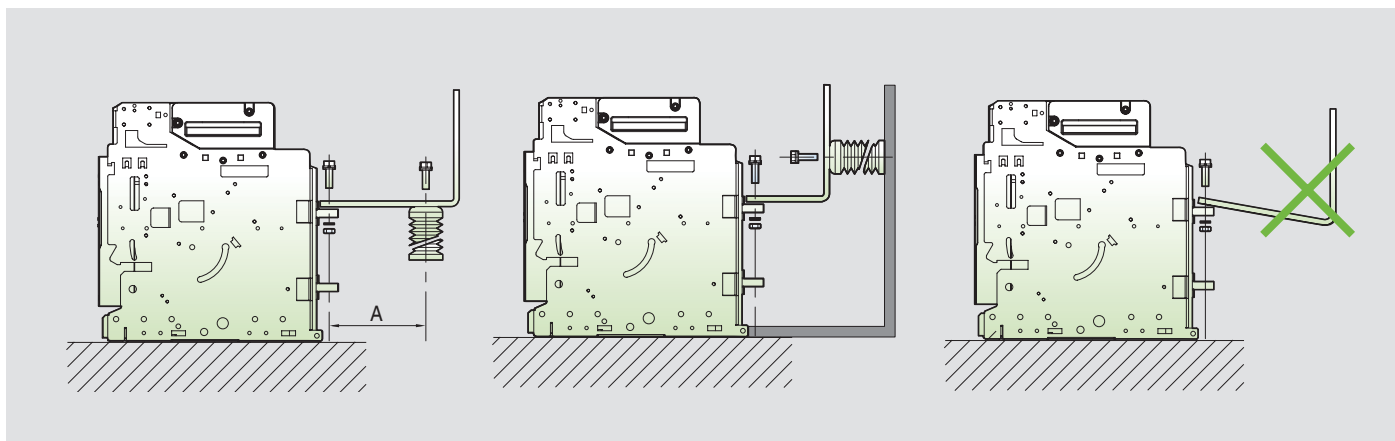

(Table 1) Maximum safe distance A

Short capacity (kA)	30	50	65	80	100	150
Length A (mm)	350	300	250	150	150	150

DIGITAL SUPPORT HUB

SCAN THE QR CODE FOR INSTANT PRODUCT INFORMATION AND EXPERT SUPPORT

Beyond XTM
Beyond Expectations



LSE LENS

One Scan,
More Materials

Scan the QR code to instantly access product materials



Product Finder

Search Smarter.
Find Faster

Quickly discover the best-fit product for your needs



Download Center

Download with
Ease and Speed

Instantly access datasheets, manuals, and CAD files



Tech Hub-YouTube

Expert Guidance,
Now on YouTube

Watch trusted tutorials and product guides from real experts



LS ELECTRIC America Inc. Chicago Head Office

625 Heathrow Dr, Lincolnshire, IL 60069, USA

Tel: 1-224-352-2265 E-Mail: sales.us@lselectricamerica.com

Headquarter

127 LS-ro (Hogye-dong) Dongan-gu, Anyang-si, Gyeonggi-Do, 14119, Korea

Seoul Office

LS Yongsan Tower, 92, Hangang-daero, Yongsan-gu, Seoul, 04386, Korea

TEL: 82-2-2034-4916, 4684, 4429

China

LS ELECTRIC (Dalian) Co., Ltd.

+86-411-8730-7560

china.dalian@lselectric.com.cn

LS ELECTRIC (Wuxi) Co., Ltd.

+86-510-8534-6666

china.wuxi@lselectric.com.cn

LS ELECTRIC (Lishui) Co., Ltd.

+86-133-6207-7980

china.lishui@lselectric.com.cn

Shanghai Office

+86-21-5237-9977

china@lselectric.com.cn

Beijing Office

+86-10-5095-1631

china@lselectric.com.cn

Guangzhou Office

+86-20-3818-2883

china@lselectric.com.cn

Qingdao Office

+86-532-8501-2065

china@lselectric.com.cn

Chengdu Office

+86-28-8670-3201

china@lselectric.com.cn

Nanjing Office

+86-25-8467-0005

china@lselectric.com.cn

India

India Office

+91-80-6142-9108

info_india@ls-electric.com

Indonesia

PT. LS ELECTRIC INDONESIA

+62-21-2933-7614

indonesia@ls-electric.com

PT SYMPHOS ELECTRIC

+62-81-1900-1474

marketing@symphos-weltraf.com

Italy

Italy office

+39-030-8081-833

italia@ls-electric.com

Japan

LS ELECTRIC Japan Co., Ltd.

+81-3-6268-8241

japan@ls-electric.com

Tokyo Office

+81-3-6268-8241

tokyo@ls-electric.com

Netherlands

LS ELECTRIC Europe B.V.

+31-20-654-1424

europartner@ls-electric.com

Russia

Moscow Office

+7-499-682-6130

info@lselectric-ru.com

Singapore

Singapore Office

+65-6958-8162

singapore@ls-electric.com

Spain

LS ELECTRIC IBERIA S.L.U.

+34-910-28-02-74

iberia@ls-electric.com

Thailand

Bangkok Office

+66-2-128-0295

thailand@ls-electric.com

Türkiye

LS ELECTRIC Türkiye Co., Ltd.

+90-212-806-1252

turkiye@ls-electric.com

U.A.E

LS ELECTRIC Middle East FZE (Dubai)

+971-4-886-5360

middleeast@ls-electric.com

USA

LS ELECTRIC America Inc.

+1-800-891-2941

sales.us@lselectricamerica.com

LS ENERGY SOLUTIONS LLC

+1-980-221-0654

cmfeldman@ls-es.com

MCM Engineering II

+1-435-865-0125

sales.us@lselectricamerica.com

America Western Office

+1-949-333-3140

america@ls-electric.com

America Bastrop Campus

+1-224-352-2265

sales.us@lselectricamerica.com

Vietnam

LS ELECTRIC Vietnam Co., Ltd.

+84-222-2221-110

vietnam@ls-electric.com

Hanoi Sales Office

+84-24-6275-8054

vietnam@ls-electric.com

Ho Chi Minh Sales Office

+84-3823-7890

vietnam@ls-electric.com

Specifications in this catalog are subject to change without notice due to continuous product development and improvement

© 2017. 9 LS ELECTRIC Co., Ltd. All rights reserved. / English (05) 2025. 12 Staffcom

www.LSElectricAmerica.com