



Beyond™

Susol UL DC MCCB
UL 1500VDC MCCB



LS ELECTRIC

Characteristics and Rating

Characteristics

- Applications include photovoltaic (PV) power generation, UPS, data center and more
- Compact size with 20 to 65kA breaking capacity
- Maximum breaking capacity
- Nominal voltage ranges up to 1500V DC
- Rated current and No. of poles
 - UL489 - 60~550A
 - UL489B - 40~450A
- Standards: IEC/UL rated



Rating

FRAME		UTD250			UTD400			UTD600		
Rated voltage		1500 Vdc			1500 Vdc			1500 Vdc		
Rated current	UL489 for BPS (40°C)	60, 80, 100, 150, 200, 250A			275, 300, 400A			450, 500, 550A		
	UL489B for PV (50°C)	40, 60, 80, 100, 150, 200A			250, 275A			300, 400, 450A		
Number of poles		4			4			4		
Breaker type		E	N	H	E	N	H	E	N	H
UL489 for BPS/ UL489B for PV		UTD250			UTD400			UTD600		
Interrupting Capacity(kA) UL, CSA		20	50	65	20	50	65	20	50	65
IEC 60947-2		UTD250			UTD400			UTD600		
Ultimate breaking capacity (kA) DC, Icu		20	40	50	20	40	50	20	40	50
Service breaking capacity (kA) DC, Ics	$\tau = 1\text{ms(Annex P)}$	20	40	50	20	40	50	20	40	50
	$\tau = 10\text{ms}$	20	20	20	20	20	20	20	20	20
Insulation voltage, Ui		1500 Vdc			1500 Vdc			1500 Vdc		
Impulse withstand voltage, Uimp		8 kV			8 kV			8 kV		
Utilization category		A			A			A		
IEC 60947-3		UTD250			UTD400			UTD600		
Insulation voltage, Ui		1500 Vdc			1500 Vdc			1500 Vdc		
Impulse withstand voltage, Uimp		8 kV			8 kV			8 kV		
Rated short-time withstand current (Icw)		3 kA			4 kA			5 kA		
Utilization category		DC23A, DC-PV2			DC23A, DC-PV2			DC23A, DC-PV2		
Trip unit		UL489	UL489B		UL489	UL489B		UL489	UL489B	
	FTU*	60~250A	40~200A		275~400A	250, 275A		450~550A	300~450A	
	FMU*	60~250A	60~200A		275~400A	275A		450, 550A	300~450A	
	MCS**	250A	200A		400A	275A		550A	450A	
	DSU***	250A			400A			550A		
Unit mounted		available			available			available		
Mechanical lugs		available			available			available		
Control wire terminal kit		available			available			available		
Motor operator		available			available			available		
Terminal shields		available			available			available		
Insulation barrier		available			available			available		
Shunt Trip		available			available			available		
Undervoltage trip		available			available			available		
Auxiliary switch		available			available			available		
Alarm switch		available			available			available		
Directly-Mounted rotary operating handle		available			available			available		
IEC door-mounted operating mechanisms		available			available			available		
Padlock attachment		available			available			available		
Weight(approximate), lbs.(kg)		6.08(2.76)			15.41(6.99)			15.43(7)		
Dimensions Inches(mm)		W	H	D	W	H	D	W	H	D
		5.51(140)	7.87(200)	3.62(92)	7.34(186.5)	11.42(290)	4.33(110)	7.34(186.5)	13.39(340)	4.33(110)

* FTU, FMU: UL489, UL489B, IEC 60947-2

** UL 489, UL 489B Only

*** IEC 60947-3 Only

External configuration

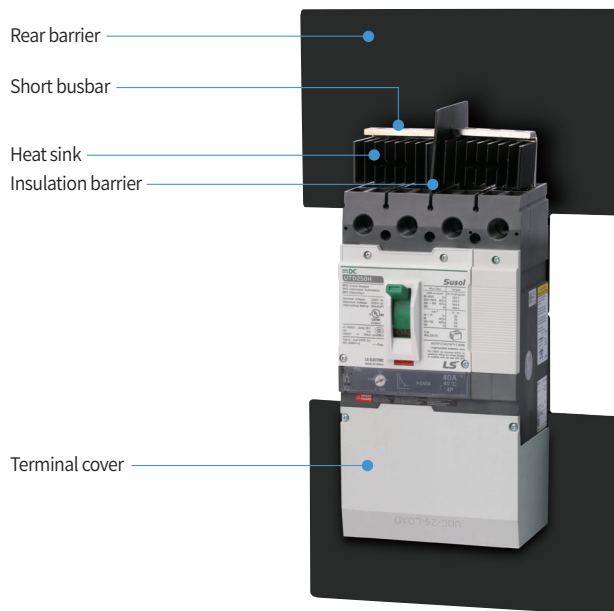

External accessories

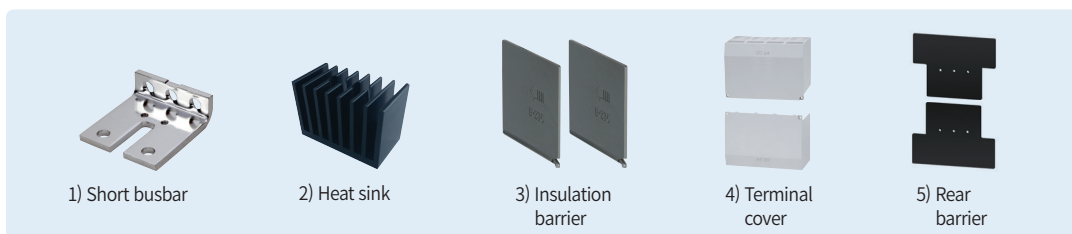

Number of accessories that can be assembled on MCCB (accessories must be purchased separately)

Accessory	Grounded System		Ungrounded System		Item code	Notes
	Qty	Unit	Qty	Unit		
Short busbar	3	Set	2	Set	83261172113	For UTD250, 40~200A, Set of 1
					83261172112	For UTD250, 250A, Set of 1
					83261173650	For UTD400/600, 250~500A, Set of 1
					83261173651	For UTD400/600, 550A~600A, Set of 1
Insulation barrier	3	ea	4	ea	-	Included in MCCB spare parts or MCS package
Terminal cover (Line)	1	ea	1	ea	83261172111 83261173557	For UTD250 For UTD400/600
Terminal cover (Load)	1	ea	1	ea		
Rear barrier (1ea)	2	ea	2	ea		

Note: For 400A ungrounded system, order MCCB or MCS , 83261173650 x2 and 83261173557 x1

Possible configuration of internal accessories.

Frame	Internal accessory Locations	Type	Left(R)	Right(T)
UTD250		AX	1	1
		AL	1	-
		SHT	1*	-
		UVT	1*	-
UTD400 UTD600		AX	3	-
		AL	-	1
		SHT	1*	-
		UVT	1*	-

* Applicable in indicated pole position, not synchronous

Assembly and installation

Short bus set

Dim.	Length		
	UTD250	UTD400	UTD600
a	0.98in (25mm)	1.22in (31mm)	1.22in (31mm)
b	0.2in (5mm)	0.24in (6mm)	0.39in (10mm)
c	2.05in (52mm)	1.81in (46mm)	1.81in (46mm)
d	0.39in (10mm)	0.55in (14mm)	0.55in (14mm)
e	3.19in (81mm)	5.28in (134mm) 4.88in (124mm)	5.28in (134mm)
f	2.36in (60mm)	3.07in (78mm)	3.07in (78mm)

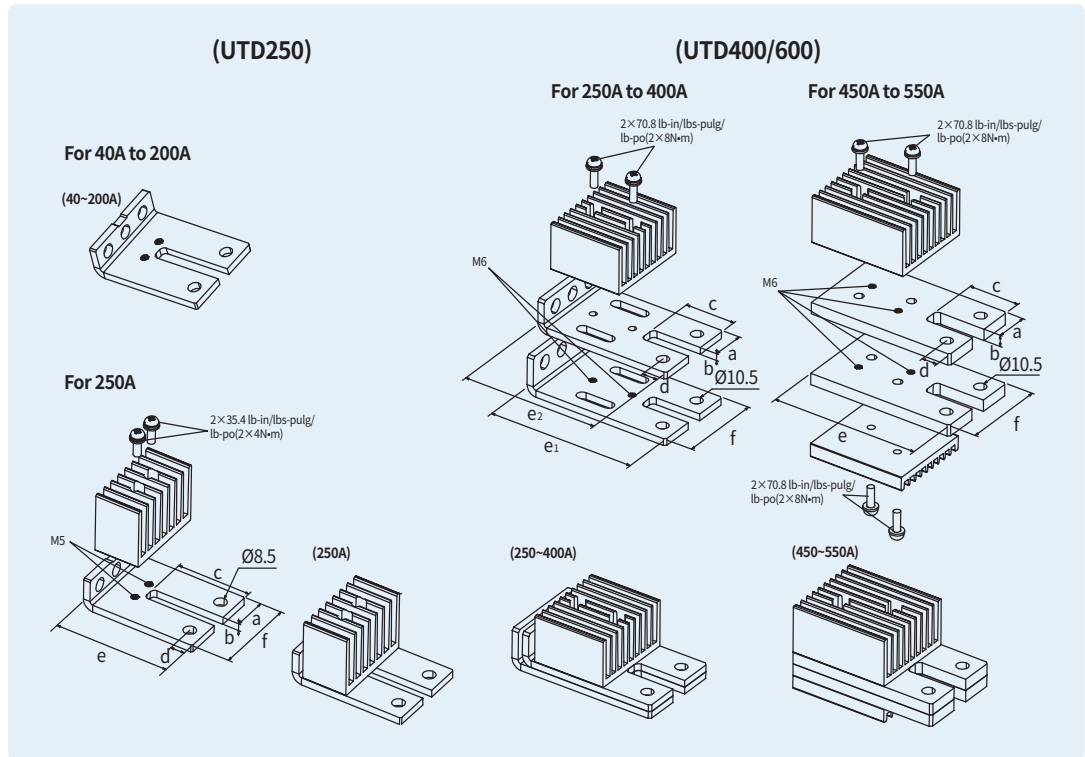



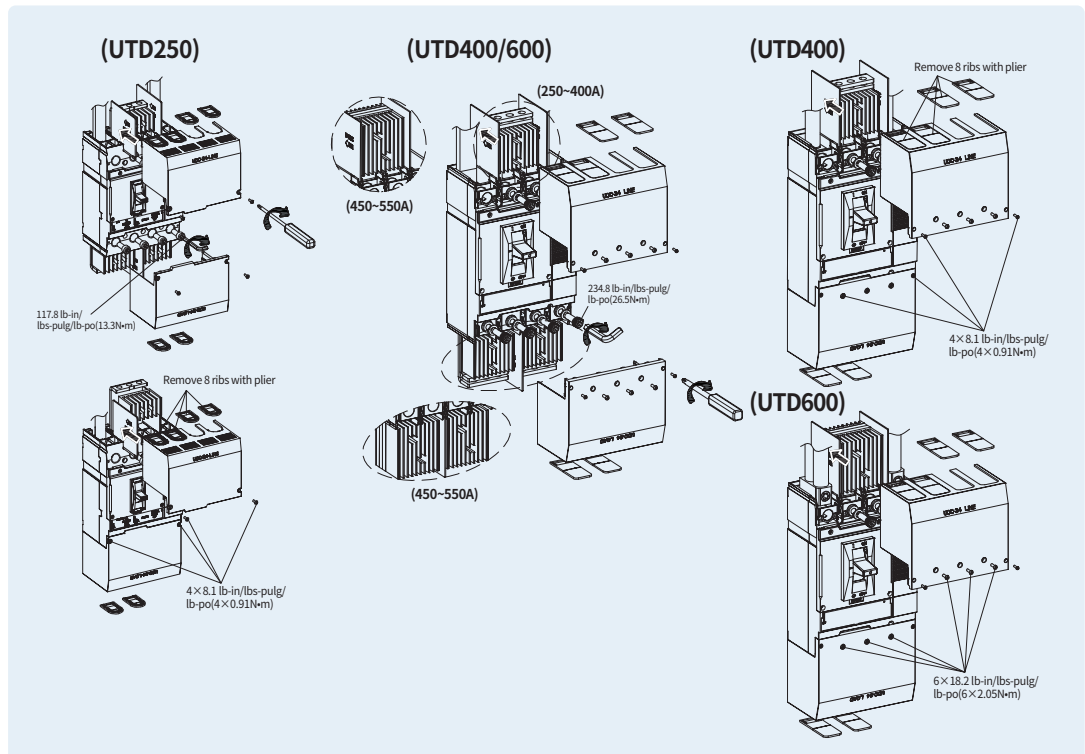







Short bus installation

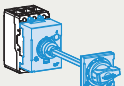

Accessories order code

UL 1500VDC MCCB

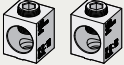
Accessories		Order code	Part number	Applied MCCB
	Aux. contact	83011171301	AX	UTD250/400/600
	Alarm contact	83011171302	AL	UTD250/400/600
	Shunt trip	83211171331	SHT, DC12V	UTD250/400/600
		83211171332	SHT, AC/DC24V	UTD250/400/600
		83211171333	SHT, AC/DC48V	UTD250/400/600
		83211171334	SHT, AC/DC110~130V	UTD250/400/600
		83211171335	SHT, AC220~240V/DC250V	UTD250/400/600
		83211171336	SHT, AC380~500V	UTD250/400/600
	Under-Voltage release	83211171351	UVT, AC/DC24V	UTD250/400/600
		83211171352	UVT, AC/DC48V	UTD250/400/600
		83211171353	UVT, AC/DC110~130V	UTD250/400/600
		83211171354	UVT, AC220~240V/DC250V	UTD250/400/600
		83211171355	UVT, AC380~440V	UTD250/400/600
		83211171356	UVT, AC440~480V	UTD250/400/600
	Padlock	56771172301	PL2	UTD250
		56771173301	PL3	UTD400/600
	Palate handle lock	56771172303	PHL2	UTD250
		56771173303	PHL3	UTD400/600
	Direct handle w/o key lock	83111172311	DH2	UTD250
		83111173311	DH3	UTD400/600
	Direct handle w/ key lock	83111172312	DHK2	UTD250
		83111173312	DHK3	UTD400/600
	Door disconnect (Standard)	83111172309	REH-2, w/ 12inch shaft	UTD250
		83111173309	REH-3, w/ 12inch shaft	UTD400/600
		83111172310	REH-2, w/o shaft	UTD250
		83111173310	REH-3, w/o shaft	UTD400/600
	Motor operator	83471172301	MOP2U, DC24V	UTD250
		83471172302	MOP2U, AC110V/DC110V	UTD250
		83471172303	MOP2U, AC230V/DC220V	UTD250
		83471173201	MOP3U, DC24V	UTD400/600
		83471173202	MOP3U, AC110V/DC110V	UTD400/600
		83471173203	MOP3U, AC230V/DC220V	UTD400/600
	Motor operator w/ lock function	83471172304	MOP2U-L, DC24V	UTD250
		83471172305	MOP2U-L, AC110V/DC110V	UTD250
		83471172306	MOP2U-L, AC230V/DC220V	UTD250
		83471173204	MOP3U-L, DC24V	UTD400/600
		83471173205	MOP3U-L, AC110V/DC110V	UTD400/600
		83471173206	MOP3U-L, AC230V/DC220V	UTD400/600
	Lug terminal	70821172030	AL250TS(set of 2)	UTD250
		70821173052	AL400TS(set of 2)	UTD400
		70821173051	AL600TS(set of 2)	UTD600

Characteristic curve

UTD250 MCCB

FTU
FMU
40, 60, 80, 100,
150, 200, 250A

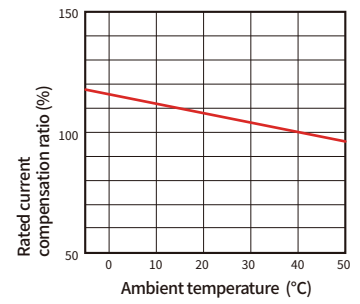
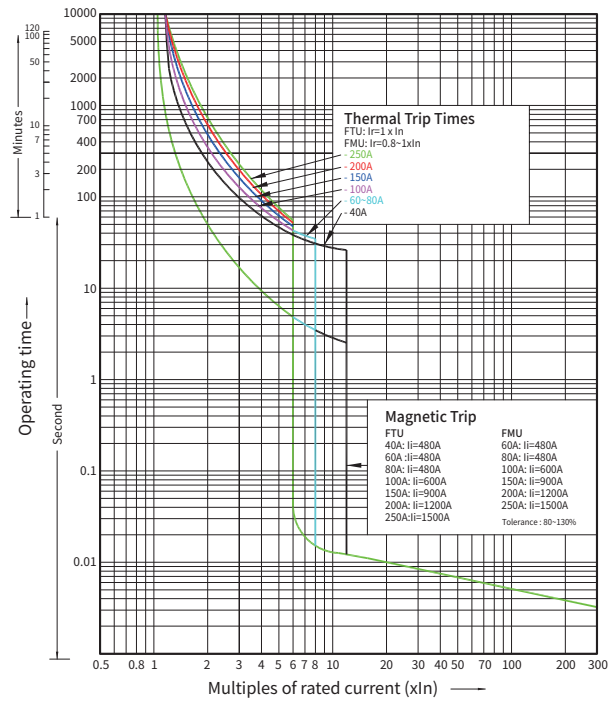

UTD250 MCS

MCS
200, 250A

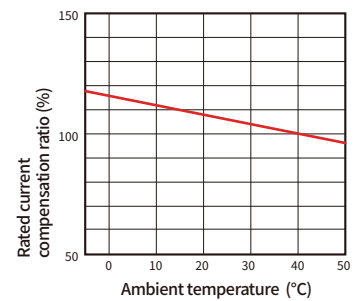
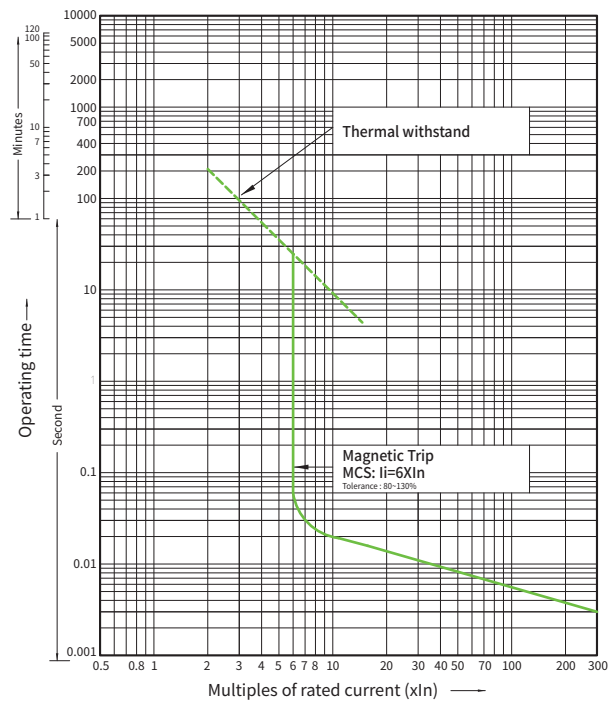

UTD400/600 MCCB

FTU
 FMU
 250, 275, 300, 400,
 450, 500, 550A

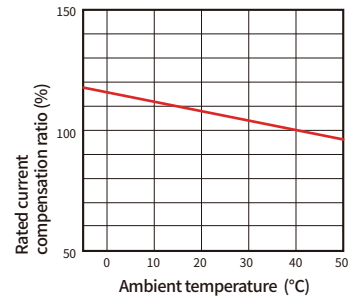
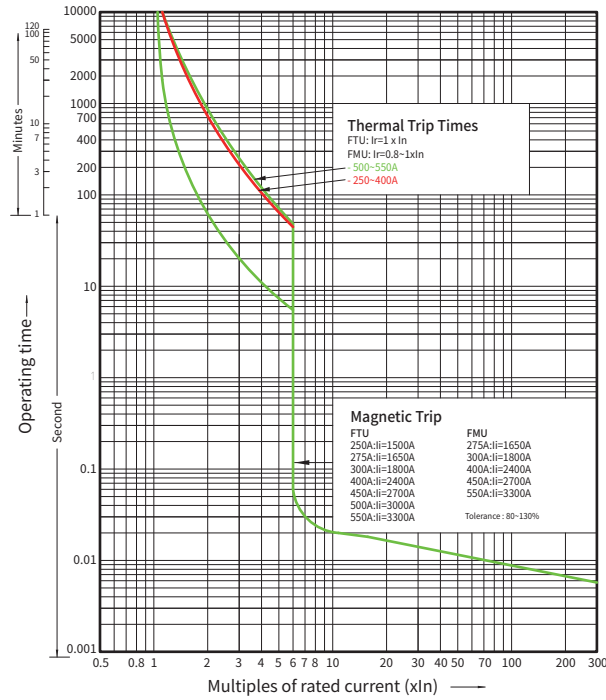

UTD400/600 MCS

MCS
 275, 400, 450,
 550A

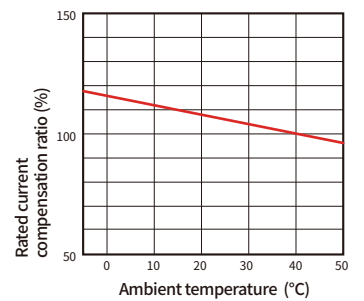
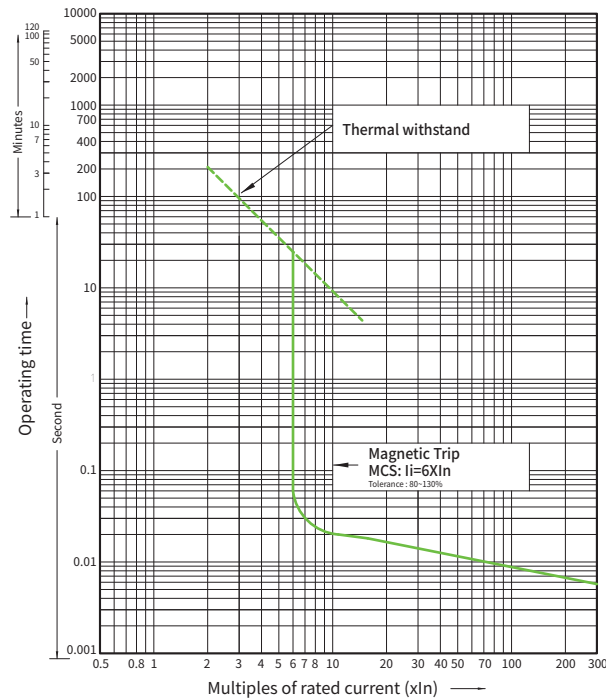

Dimensions

UTD250

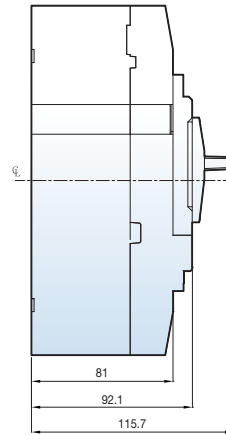
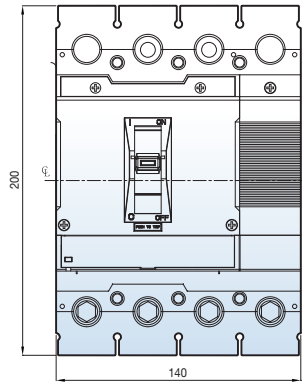

< Panel drilling >

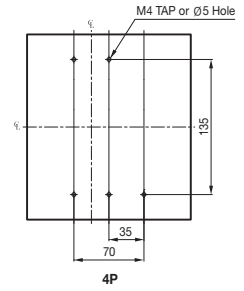

< Front panel cutting >

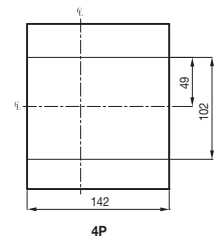

Terminal section

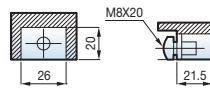

Conductor

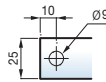

< Short busbar apply >

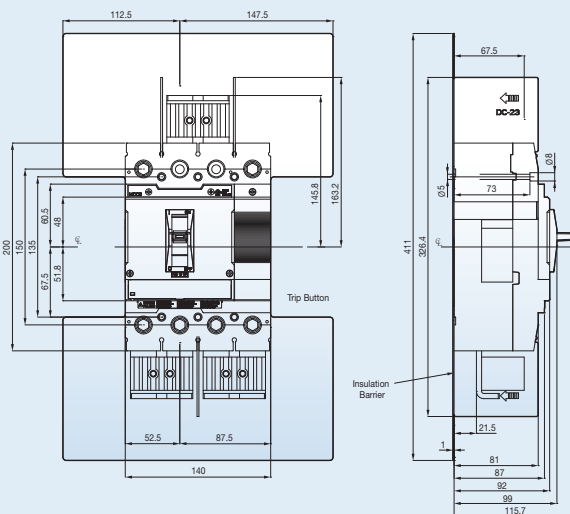

< Terminal cover apply >

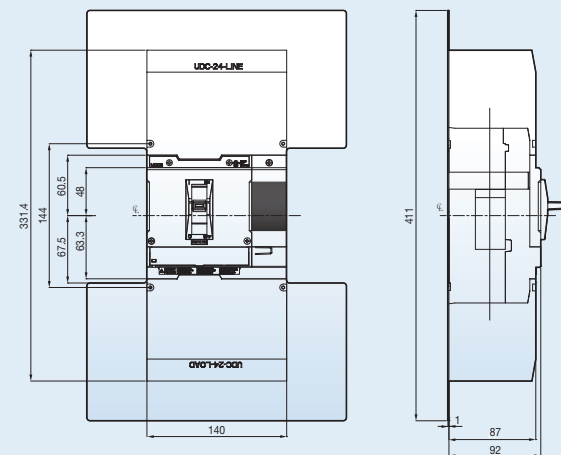

UTD400

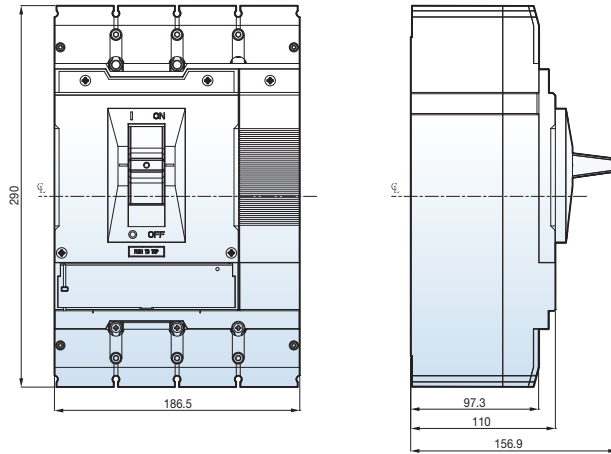

< Panel drilling >

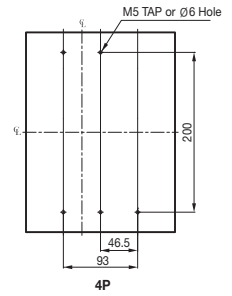

< Front panel cutting >

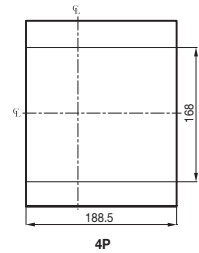

Terminal section

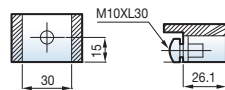

Conductor

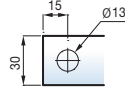

< Short busbar apply >

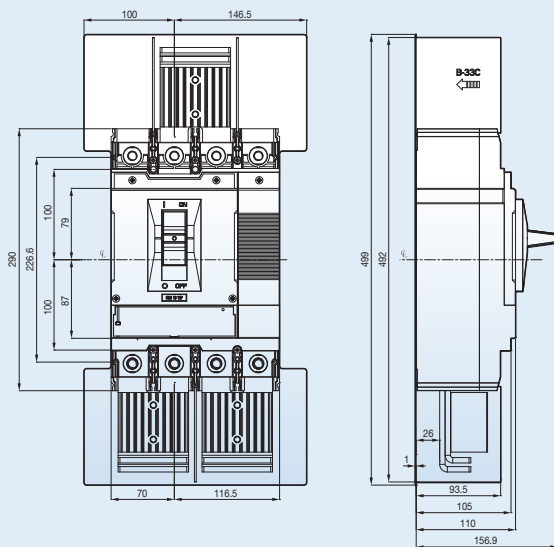

< Terminal cover apply >

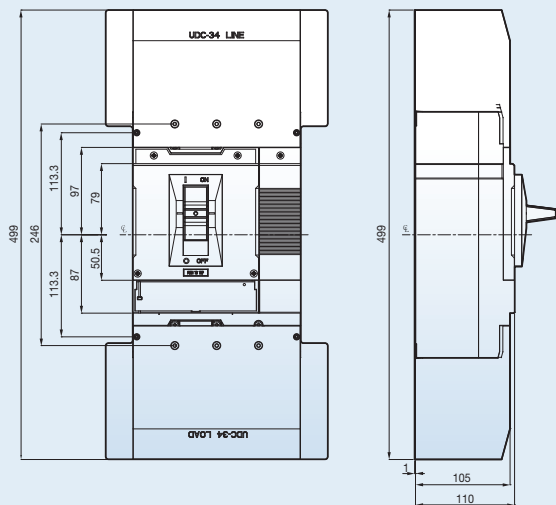

Dimensions

UTD600

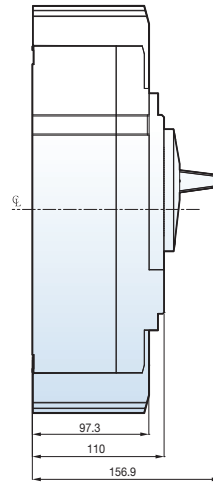
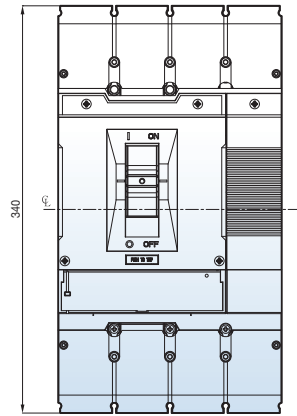

< Panel drilling >

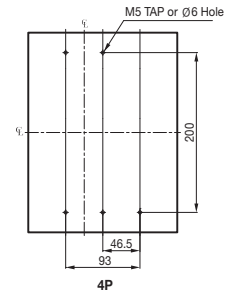

< Front panel cutting >

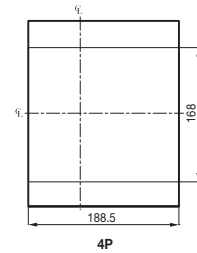

Terminal section

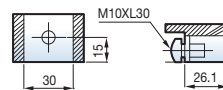

Conductor

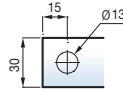

< Short busbar apply >

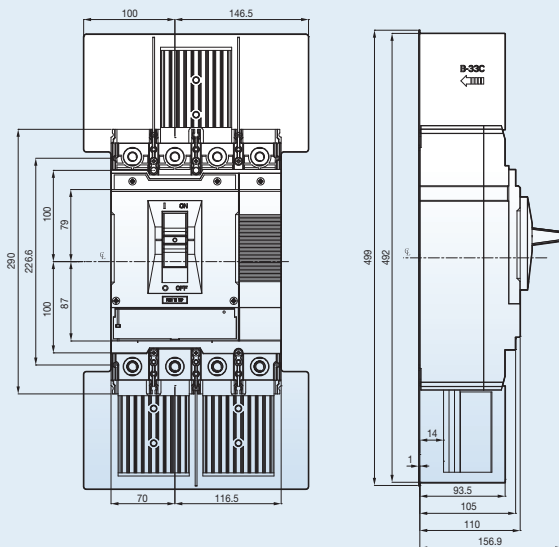

< Terminal cover apply >

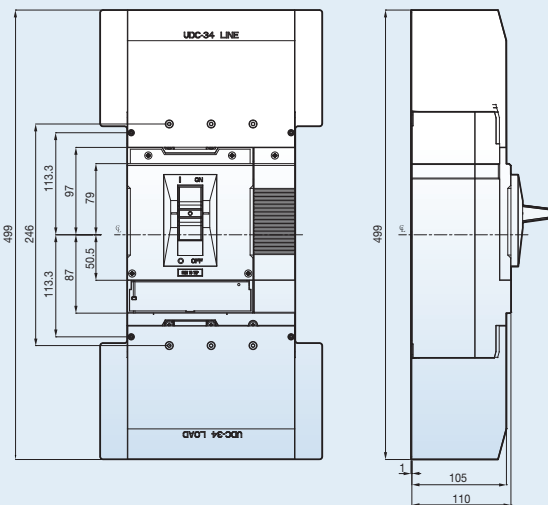

Wiring diagram and temperature derating

UL 1500VDC MCCB

Wiring diagram

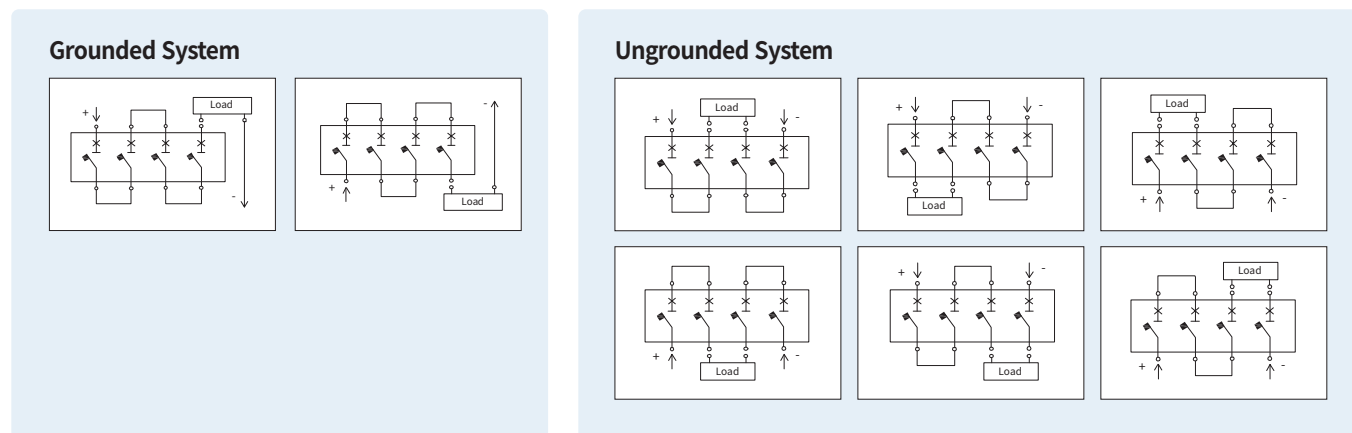

Temperature derating

Type	Rated Current (A)	Derating Current (A)	Compensated rated current in accordance with ambient temperature(A)										Terminal Connection								
			10°C		20°C		30°C		40°C		45°C			50°C		60°C		70°C			
UL489	UTD250	60	60	100%	60	100%	60	100%	60	100%	60	100%	59	98%	57	95%	53	89%	50	83%	Busbar 5T (Item Code 83261172113)
		80	80	100%	80	100%	80	100%	80	100%	80	100%	78	98%	76	95%	71	89%	66	83%	Busbar 5T (Item Code 83261172113)
		100	100	100%	100	100%	100	100%	100	100%	100	100%	98	98%	95	95%	89	89%	83	83%	Busbar 5T (Item Code 83261172113)
		150	150	100%	150	100%	150	100%	150	100%	150	100%	146	97%	141	94%	132	88%	123	82%	Busbar 5T (Item Code 83261172113)
		200	200	100%	200	100%	200	100%	200	100%	200	100%	196	98%	190	95%	178	89%	166	83%	Busbar 5T (Item Code 83261172113)
	UTD400	250	250	100%	250	100%	250	100%	250	100%	250	100%	243	97%	235	94%	220	88%	205	82%	Busbar 5T + Heat Sink (Item Code 83261172112)
		275	275	100%	275	100%	275	100%	275	100%	275	100%	267	97%	259	94%	242	88%	226	82%	Busbar 6T x 2 + Heat Sink (Item Code 83261173650)
		300	300	100%	300	100%	300	100%	300	100%	300	100%	291	97%	281	94%	264	88%	246	82%	Busbar 6T x 2 + Heat Sink (Item Code 83261173650)
	UTD600	400	400	100%	400	100%	400	100%	400	100%	400	100%	390	98%	378	95%	357	89%	333	83%	Busbar 6T x 2 + Heat Sink (Item Code 83261173650)
		450	450	100%	450	100%	450	100%	450	100%	450	100%	441	98%	428	95%	401	89%	374	83%	Busbar 10T x 2 + Heat Sink x 2 (Item Code 83261173651)
500		500	100%	500	100%	500	100%	500	100%	500	100%	488	98%	476	95%	446	89%	416	83%	Busbar 10T x 2 + Heat Sink x 2 (Item Code 83261173651)	
	550	550	100%	550	100%	550	100%	550	100%	550	100%	532	97%	515	94%	486	88%	453	82%	Busbar 10T x 2 + Heat Sink x 2 (Item Code 83261173651)	

Type	Rated Current (A)	Derating Current (A)	Compensated rated current in accordance with ambient temperature(A)										Terminal Connection								
			10°C		20°C		30°C		40°C		45°C			50°C		60°C		70°C			
UL489B	UTD250	40	40	100%	40	100%	40	100%	40	100%	40	100%	40	100%	40	100%	39	98%	38	95%	Busbar 5T (Item Code 83261172113)
		60	60	100%	60	100%	60	100%	60	100%	60	100%	60	100%	60	100%	59	98%	57	95%	Busbar 5T (Item Code 83261172113)
		80	80	100%	80	100%	80	100%	80	100%	80	100%	80	100%	80	100%	78	98%	76	95%	Busbar 5T (Item Code 83261172113)
		100	100	100%	100	100%	100	100%	100	100%	100	100%	100	100%	100	100%	98	98%	95	95%	Busbar 5T (Item Code 83261172113)
		150	150	100%	150	100%	150	100%	150	100%	150	100%	150	100%	150	100%	146	97%	141	94%	Busbar 5T (Item Code 83261172113)
	UTD400	200	200	100%	200	100%	200	100%	200	100%	200	100%	200	100%	200	100%	196	98%	190	95%	Busbar 5T + Heat Sink (Item Code 83261172112)
		250	250	100%	250	100%	250	100%	250	100%	250	100%	250	100%	250	100%	243	97%	235	94%	Busbar 6T x 2 + Heat Sink (Item Code 83261173650)
		275	275	100%	275	100%	275	100%	275	100%	275	100%	275	100%	275	100%	267	97%	259	94%	Busbar 6T x 2 + Heat Sink (Item Code 83261173650)
	UTD600	300	300	100%	300	100%	300	100%	300	100%	300	100%	300	100%	300	100%	291	97%	281	94%	Busbar 6T x 2 + Heat Sink (Item Code 83261173650)
		400	400	100%	400	100%	400	100%	400	100%	400	100%	400	100%	400	100%	390	98%	378	95%	Busbar 6T x 2 + Heat Sink (Item Code 83261173650)
450		450	100%	450	100%	450	100%	450	100%	450	100%	450	100%	450	100%	441	98%	428	95%	Busbar 10T x 2 + Heat Sink x 2 (Item Code 83261173651)	



LS ELECTRIC America Inc. Chicago Head Office

625 Heathrow Dr, Lincolnshire, IL 60069, USA
Tel: 1-224-352-2265 E-Mail: sales.us@lselectricamerica.com

Headquarter

127 LS-ro (Hogye-dong) Dongan-gu, Anyang-si, Gyeonggi-Do, 14119, Korea

Seoul Office

LS Yongsan Tower, 92, Hangang-daero, Yongsan-gu, Seoul, 04386, Korea
TEL: 82-2-2034-4916, 4684, 4429

China

LS ELECTRIC (Dalian) Co., Ltd.
+86-411-8730-7560
china.dalian@lselectric.com.cn

LS ELECTRIC (Wuxi) Co., Ltd.
+86-510-8534-6666
china.wuxi@lselectric.com.cn

LS ELECTRIC (Lishui) Co., Ltd.
+86-133-6207-7980
china.lishui@lselectric.com.cn

Shanghai Office
+86-21-5237-9977
china@lselectric.com.cn

Beijing Office
+86-10-5095-1631
china@lselectric.com.cn

Guangzhou Office
+86-20-3818-2883
china@lselectric.com.cn

Qingdao Office
+86-532-8501-2065
china@lselectric.com.cn

Chengdu Office
+86-28-8670-3201
china@lselectric.com.cn

Nanjing Office
+86-25-8467-0005
china@lselectric.com.cn

India

India Office
+91-80-6142-9108
Info_india@ls-electric.com

Indonesia

PT. LS ELECTRIC INDONESIA
+62-21-2933-7614
indonesia@ls-electric.com

PT SYMPHOS ELECTRIC
+62-81-1900-1474
marketing@symphos-weltraf.com

Italy

Italy office
+39-030-8081-833
italia@ls-electric.com

Japan

LS ELECTRIC Japan Co., Ltd.
+81-3-6268-8241
japan@ls-electric.com

Tokyo Office
+81-3-6268-8241
tokyo@ls-electric.com

Netherlands

LS ELECTRIC Europe B.V.
+31-20-654-1424
europartner@ls-electric.com

Russia

Moscow Office
+7-499-682-6130
info@lselectric-ru.com

Singapore

Singapore Office
+65-6958-8162
singapore@ls-electric.com

Spain

LS ELECTRIC IBERIA S.L.U.
+34-910-28-02-74
iberia@ls-electric.com

Thailand

Bangkok Office
+66-2-128-0295
thailand@ls-electric.com

Türkiye

LS ELECTRIC Türkiye Co., Ltd.
+90-212-806-1252
turkiye@ls-electric.com

U.A.E

LS ELECTRIC Middle East FZE (Dubai)
+971-4-886-5360
middleeast@ls-electric.com

USA

LS ELECTRIC America Inc.
+1-800-891-2941
sales.us@lselectricamerica.com

LS ENERGY SOLUTIONS LLC
+1-980-221-0654
cmfeldman@ls-es.com

MCM Engineering II
+1-435-865-0125
sales.us@lselectricamerica.com

America Western Office
+1-949-333-3140
america@ls-electric.com

America Bastrop Campus
+1-224-352-2265
sales.us@lselectricamerica.com

Vietnam

LS ELECTRIC Vietnam Co., Ltd.
+84-222-2221-110
vietnam@ls-electric.com

Hanoi Sales Office
+84-24-6275-8054
vietnam@ls-electric.com

Ho Chi Minh Sales Office
+84-3823-7890
vietnam@ls-electric.com

DIGITAL SUPPORT HUB



LSE LENS

Scan the QR code to instantly access product materials



Product Finder

Quickly discover the best-fit product for your needs



Download Center

Instantly access datasheets, manuals, and CAD files



Tech Hub-Youtube

Watch trusted tutorials and product guides from real experts

Specifications in this catalog are subject to change without notice due to continuous product development and improvement

© 2021. 08 LS ELECTRIC Co., Ltd. All rights reserved. / English (04) 2025. 12 Staffcom

www.LSElectricAmerica.com