

Beyond™

**Metasol
Manual Motor Starters**



LS ELECTRIC

Metasol *Meta Solution*

MANUAL MOTOR STARTERS

LS ELECTRIC Manual Motor Starters (MMS) ensure safe operations through improved short circuit performance with added value through robust trip function and enhanced quality serving as a new motor protection solution!

The products offer reliable performance, superior durability and global competitiveness.

MMS provides high performance for short circuit, overload and phase failure protection with high durability to keep your system and load devices safe.

The global products have passed IEC and UL specifications and have been verified for their excellence.



MMS-32D

MMS-32S

MMS-32H

MMS-63S



MMS-100H



Certification

• IEC60947 / UL508 / K 60947 / GB 14048



Contents

Features	4
Product Selection Guide	10
Model and Rating	13
• Standard type	13
• High breaking type	14
• Instantaneous type	15
Accessories	16
• Auxiliary contact / Alarm contact	16
• Trip device	17
• Auxiliaries	18
• MMS-32D Auxiliary contact	19
• MMS-32D Shunt release / Undervoltage release / Installation of accessories	20
• Electrical auxiliaries / Possible combination chart	21
Technical Information	25
• Installation and use environment	25
• Installation of auxiliaries	26
• IEC performance data (Motor protection)	31
• Manual motor controller (UL 508, CSA C22.2 as manual motor controllers)	34
• Manual motor controller (UL 508)	36
• Type '2' coordination according to IEC60947-4-1	38
• LS MMS ready for IE3-rated motors	39
• IE3 De-rating table	40
• Characteristic curve	41
• Thermal limit on short-circuit	42
Dimensions	45

New Performance

LS ELECTRIC Manual Motor Starters (MMS) serves as motor protection with high performance and reliability.

The products feature better technology and reliability than existing Meta-MEC MMS units due to existing overload and phase failure protection functions, upgraded short-circuit capabilities and quality.

User conditions are met for safe operation in accordance with IEC and UL standards.



Metasol Manual Motor Starters



Enhanced trip function

- New application of MMS-32/63 trip indicator enhances the visibility of trip



Reinforced product reliability

- Reinforced breaking reliability compared to existing Meta-MEC MMS



Compatibility and design differentiation

- Same external dimensions as Meta-MEC MMS
- Consistency with Metasol MC by changing color

32AF

0.1~0.16... 28~40A (17 Step)



MMS-32S
• Standard

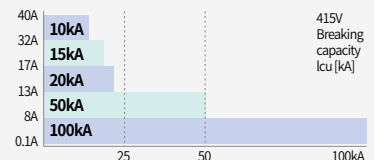

MMS-32H
MMS-32HI
• High break
• Magnetic release

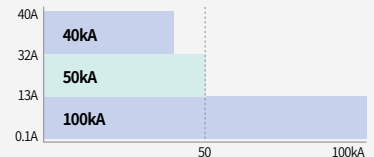



Meta-MEC 63S

Metasol 63S

Meta-MEC 100H

Metasol 100H

63AF

6~10... 47~65A (10 Step)



MMS-63S
• Standard

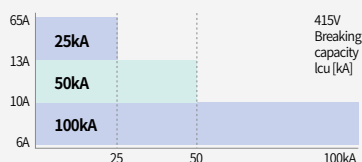

415V
Breaking capacity I_{cu} [kA]



MMS-63H
MMS-63HI
• High break
• Magnetic release

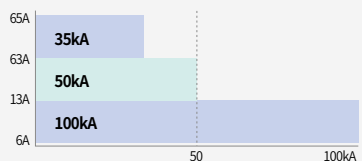

100AF

11~17... 80~100A (10 Step)



MMS-100S
• Standard



415V
Breaking capacity I_{cu} [kA]



MMS-100H
MMS-100HI
• High break
• Magnetic release

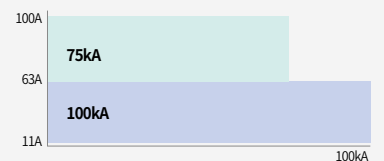

Multi-functional and Compact Size

MMS combines the functions of MCCB and TOR. The products feature simple and easy wiring capable of supporting reduced panel size. Compact designs are available up to 100 kA breaking capacity to meet various system protection requirements.

MCCB function

- Over load protection
- Short protection



TOR function

- Protection function
 - Over load protection
 - Phase failure protection
- Other function
 - Current modification
 - Wide range of ambient temperature compensation



MMS

(Manual Motor Starter)



Variety of performance



Function	Notes
Miniaturization	Panel size can be reduced to 50% or less
High breaking capacity	32AF : 50~100kA (Previous 10kA)
Various protection features	Over load, Short circuit, Phase failure protection
Current modification	±20%
Temperature used	-20°C~+60°C
Standard	IEC (60947-1, 2, 4), UL508 (Type E), GB 14048
Size	MMS-32D follows DIN 43880 standards.

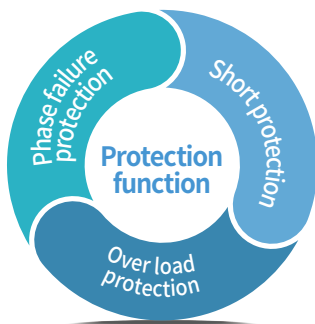

Feature

- 5mm width (32AF), 55mm width (63AF), 70mm width (100AF)
- Three position operator : On-Off-Trip (Only 100AF)
- Complete range of common accessories
- Handle lock in the Off position
- Class 10 overload trip characteristics
- Trip test
- Finger safe terminal
- Din rail and screw mounting
- Ready for IE3

External appearance

Manual Motor Starters

MMS 32H... 40A [Scale 1:1]

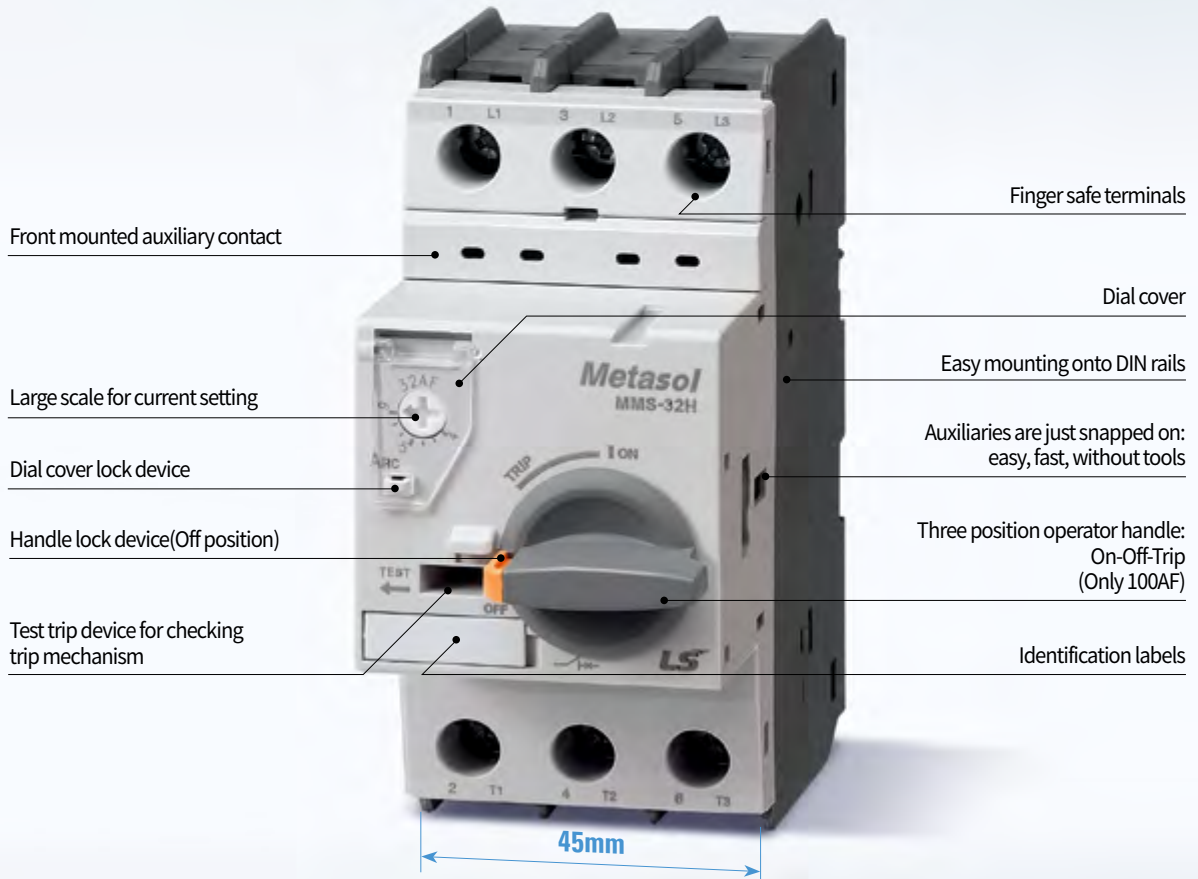

Handle lock



Dial cover



Terminals



MMS-32 (Screw)



MMS-63 (Lug)



MMS-100 (Lug)

Note) For 32AF products, the O-ring is available as a separate item; for products 63AF and above, O-ring fastening is possible with the standard lug type.

Convenience

Various accessories, common up to 100AF

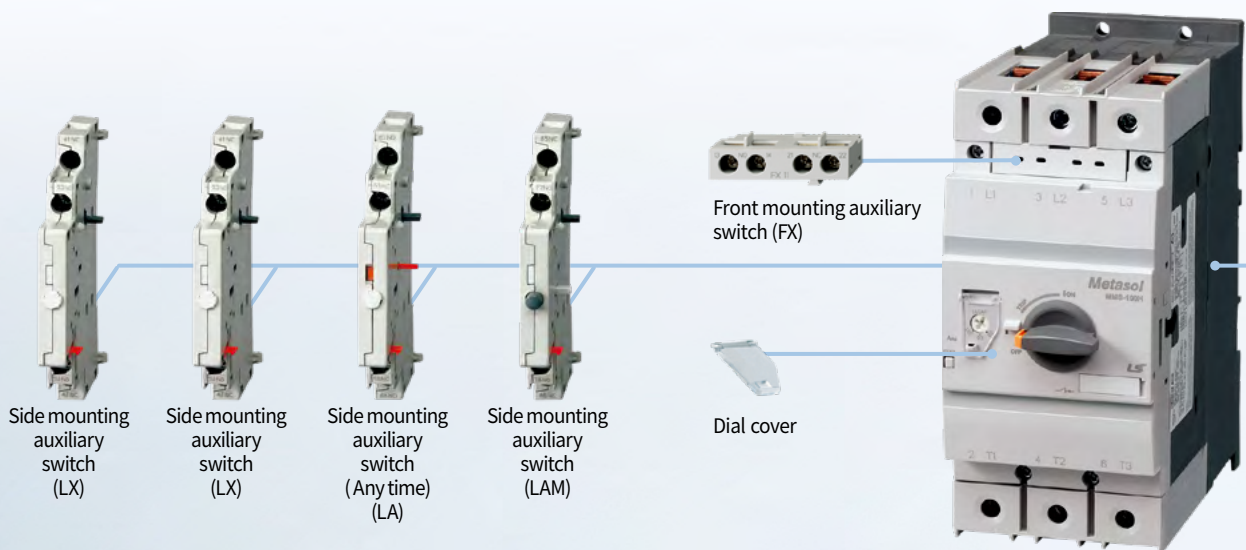
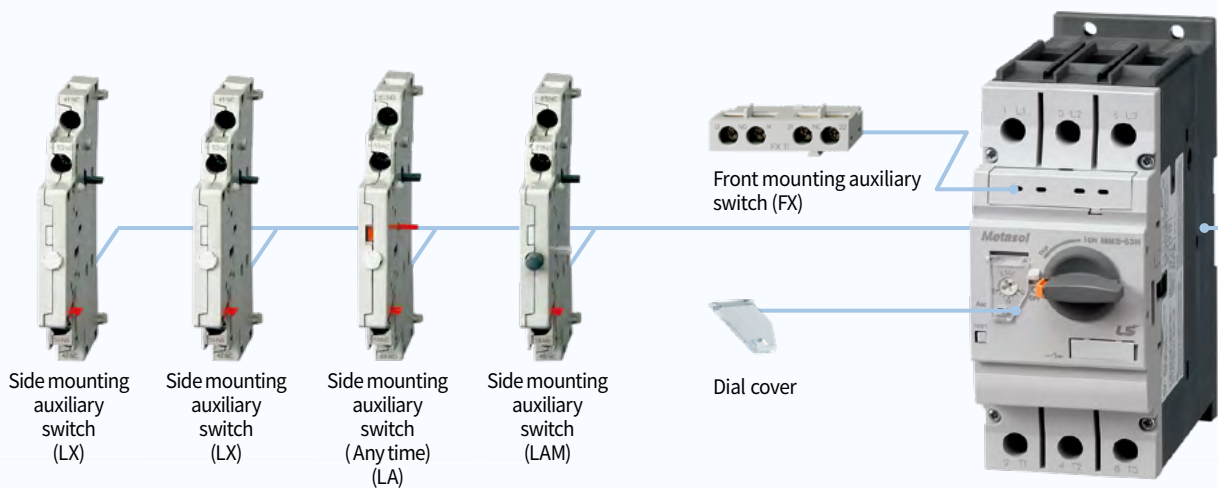
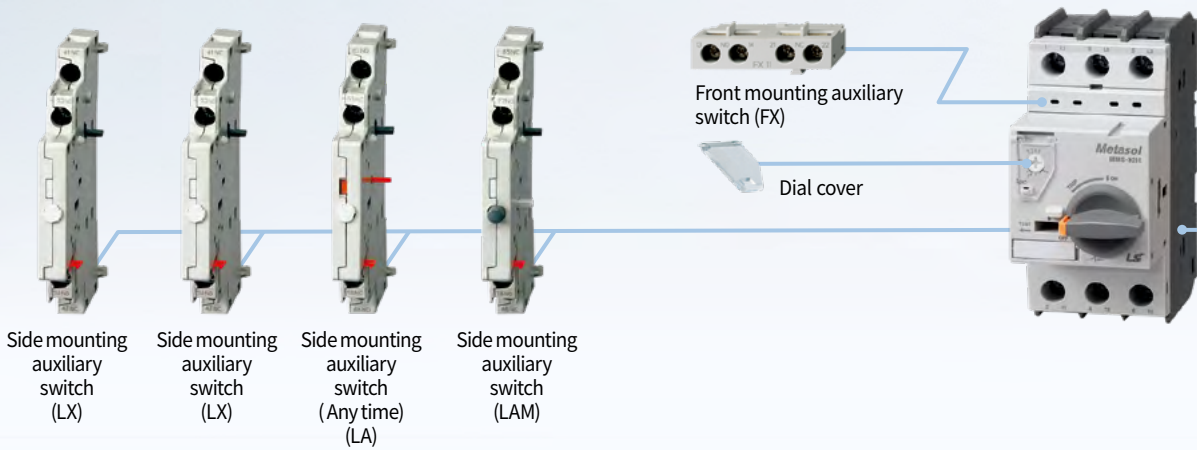

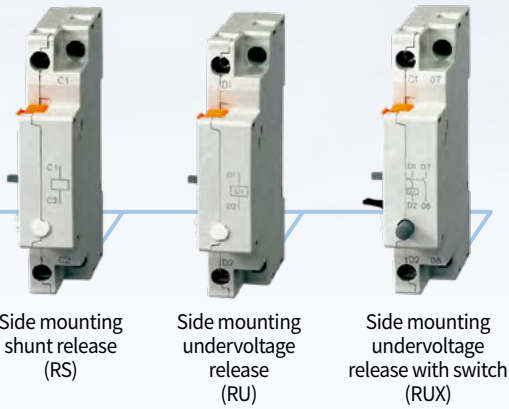

Side mounting shunt release (RS)

Side mounting undervoltage release (RU)

Side mounting undervoltage release with switch (RUX)

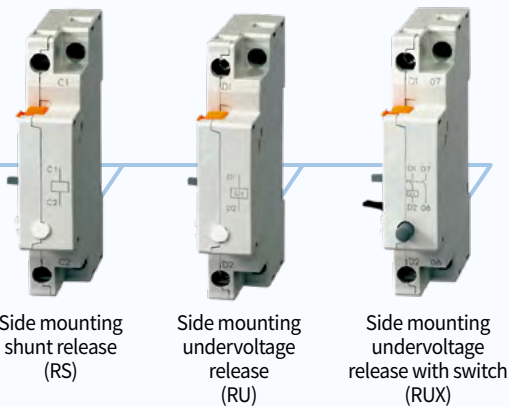

Side mounting shunt release (RS)

Side mounting undervoltage release (RU)

Side mounting undervoltage release with switch (RUX)

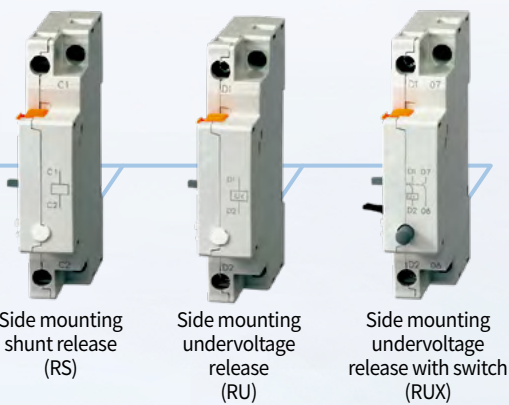

Side mounting shunt release (RS)

Side mounting undervoltage release (RU)

Side mounting undervoltage release with switch (RUX)

Direct adaptor
Mini-MC



Mini-MC (9~16A)

Direct adaptor
Metasol Susol-MC



Metasol : MC-6a~100a
Susol : MC-9~95

Note:

1. Refer to page 20 for installation of accessories.
2. LX, LA, and LAM are left attachment accessories and RS, RU, and RUX are right attachment accessories.
3. Mini-MC and Metasol/Susol MC can be connected directly to MMS. (Refer to page 20 for details of DA connectors)
4. RUX : Not available with MMS-32S.

Product Selection Guide



Frame		32AF																						
Type	Current adjustable type	MMS-32D				MMS-32S								MMS-32H										
	Instantaneous type	-				-								MMS-32HI										
Breaking capacity		-				Standard								High breaking										
Handle type		Button				Toggle								Rotary										
Number of poles		3				3								3										
Rated operational voltage (Ue)		AC 400/415V				Up to 690V								Up to 690V										
Rated frequency		50/60Hz				50/60 Hz								50/60 Hz										
Rated insulation voltage (Ui)		690V				690V								690V										
Rated impulse voltage (Uimp)		6kV				6kV								6kV										
Utilization category IEC 60 947-2 (Breaker)		Cat. A				Cat. A								Cat. A										
Utilization category IEC 60 947-4 (Motor starter)		AC 3				AC 3								AC 3										
Mechanical endurance (Operating)		100,000				100,000								100,000										
Electrical endurance (Cycles)		100,000				100,000								100,000										
Max operating frequency per hour (Ope./h)		25				25								25										
Temperature compensation (Operation)		-5 ~ +40°C				-20 ~ +60°C								-20 ~ +60°C										
Instantaneous short circuit release		14.4 × Ie max.				13 × Ie max.								13 × Ie max.										
Overload protection		○				○								MMS-32H(○), MMS-32HI(×)										
Phase failure function		○				○								MMS-32H(○), MMS-32HI(×)										
Trip indicating function		×				×								○										
Test function		○				○								○										
Certification		CE, CCC				CE, CCC, UL, EAC, Marine, KC																		
Weight (g)		285				320								360										
Rated breaking capacity (kA)	Rated operational current (Ie) / (MMS-32D)	415V 400V		240V 230V 220V		415V 400V		460V 440V		525V 500V		690V 600V		240V 230V 220V		415V 400V		460V 440V		525V 500V		690V 600V		
	Thermal release adjustment range (Ie) / (MMS-32D)	Icu	Ics	Icu	Ics	Icu	Ics	Icu	Ics	Icu	Ics	Icu	Ics	Icu	Ics	Icu	Ics	Icu	Ics	Icu	Ics	Icu	Ics	
	0.16	0.1~0.16	100	100	100	100	100	100	100	100	100	100	100	100	100	100	100	100	100	100	100	100	100	
	0.25	0.16~0.25	100	100	100	100	100	100	100	100	100	100	100	100	100	100	100	100	100	100	100	100	100	
	0.4	0.25~0.4	100	100	100	100	100	100	100	100	100	100	100	100	100	100	100	100	100	100	100	100	100	
	0.63	0.4~0.63	100	100	100	100	100	100	100	100	100	100	100	100	100	100	100	100	100	100	100	100	100	
	1	0.63~1	100	100	100	100	100	100	100	100	100	100	100	100	100	100	100	100	100	100	100	100	100	
	1.6	1~1.6	100	100	100	100	100	100	100	100	100	100	3	3	100	100	100	100	100	100	100	100	100	
	2.5	1.6~2.5	100	100	100	100	100	100	100	100	50	38	3	3	100	100	100	100	100	100	100	100	8	8
	4	2.5~4	100	100	100	100	100	100	50	38	15	11	3	3	100	100	100	100	100	100	100	100	8	8
	6/(6.3)	4~6/(4~6.3)	100	100	100	100	100	100	15	11	10	8	3	3	100	100	100	100	100	100	100	100	6	6
	8	5~8	-	-	100	100	100	100	15	11	10	8	3	3	100	100	100	100	50	38	50	38	6	6
	10	6~10	100	100	100	100	50	38	15	11	6	5	3	3	100	100	100	100	50	38	50	38	6	6
	13/(14)	9~13/(9~14)	15	7.5	100	100	50	38	10	8	6	5	3	3	100	100	100	100	50	38	42	32	6	6
	17/(18)	11~17/(13~18)	15	7.5	50	38	20	15	10	8	6	5	3	3	100	100	50	38	25	15	10	8	4	4
	22/(23)	14~22/(17~23)	15	6	40	30	15	11	8	6	6	5	3	3	100	100	50	38	25	15	10	8	4	4
	26/(25)	18~26/(20~25)	15	6	40	30	15	11	8	6	5	4	3	3	100	100	50	38	25	15	10	8	4	4
	32	22~32/(24~32)	10	6	30	22	15	11	6	4	5	4	3	3	100	100	50	38	25	15	10	8	4	4
	40	28~40	-	-	20	15	10	8	5	3	4	3	2	2	100	100	40	30	15	11	8	6	3	3
	50	34~50	-	-	-	-	-	-	-	-	-	-	-	-	-	-	-	-	-	-	-	-	-	-
63	45~63	-	-	-	-	-	-	-	-	-	-	-	-	-	-	-	-	-	-	-	-	-	-	
65	47~65	-	-	-	-	-	-	-	-	-	-	-	-	-	-	-	-	-	-	-	-	-	-	
75	55~75	-	-	-	-	-	-	-	-	-	-	-	-	-	-	-	-	-	-	-	-	-	-	
90	70~90	-	-	-	-	-	-	-	-	-	-	-	-	-	-	-	-	-	-	-	-	-	-	
100	80~100	-	-	-	-	-	-	-	-	-	-	-	-	-	-	-	-	-	-	-	-	-	-	

Note: Safety certification is obtained based on 220V and 460V.

Note: There is no current adjustment range for HI products (refer to page 15 for model and rating).



Frame		63AF																				
Type	Current adjustable type	MMS-63S						MMS-63H														
	Instantaneous type	-						MMS-63HI														
Breaking capacity		Standard						High breaking														
Handle type		Rotary						Rotary														
Number of poles		3						3														
Rated operational voltage (Ue)		Up to 690V						Up to 690V														
Rated frequency		50/60 Hz						50/60 Hz														
Rated insulation voltage (Ui)		1000V						1000V														
Rated impulse voltage (Uimp)		8kV						8kV														
Utilization category IEC 60 947-2 (Breaker)		Cat. A						Cat. A														
Utilization category IEC 60 947-4 (Motor starter)		AC 3						AC 3														
Mechanical endurance (Operating)		50,000						50,000														
Electrical endurance (Cycles)		25,000						25,000														
Max operating frequency per hour (Ope./h)		25						25														
Temperature compensation (Operation)		-20 ~ +60°C						-20 ~ +60°C														
Instantaneous short circuit release		13 × Ie max.						13 × Ie max														
Overload protection		○						MMS-32H(○), MMS-32HI(×)														
Phase failure function		○						MMS-32H(○), MMS-32HI(×)														
Trip indicating function		○						○														
Test function		○						○														
Certification		CE, CCC, UL, EAC, Marine, KC																				
Weight (g)		1,000																				
Rated breaking capacity (kA)	Rated operational current (Ie) / (MMS-32D)	Thermal release adjustment range (Ie) / (MMS-32D)	240V 230V 220V		415V 400V		460V 440V		252V 500V		690V 600V		240V 230V 220V		415V 400V		460V 440V		525V 500V		690V 600V	
			Icu	Ics	Icu	Ics	Icu	Ics	Icu	Ics	Icu	Ics	Icu	Ics	Icu	Ics	Icu	Ics	Icu	Ics	Icu	Ics
	0.16	0.1~0.16	-	-	-	-	-	-	-	-	-	-	-	-	-	-	-	-	-	-	-	-
	0.25	0.16~0.25	-	-	-	-	-	-	-	-	-	-	-	-	-	-	-	-	-	-	-	-
	0.4	0.25~0.4	-	-	-	-	-	-	-	-	-	-	-	-	-	-	-	-	-	-	-	-
	0.63	0.4~0.63	-	-	-	-	-	-	-	-	-	-	-	-	-	-	-	-	-	-	-	-
	1	0.63~1	-	-	-	-	-	-	-	-	-	-	-	-	-	-	-	-	-	-	-	-
	1.6	1~1.6	-	-	-	-	-	-	-	-	-	-	-	-	-	-	-	-	-	-	-	-
	2.5	1.6~2.5	-	-	-	-	-	-	-	-	-	-	-	-	-	-	-	-	-	-	-	-
	4	2.5~4	-	-	-	-	-	-	-	-	-	-	-	-	-	-	-	-	-	-	-	-
	6/(6.3)	4~6/(4~6.3)	-	-	-	-	-	-	-	-	-	-	-	-	-	-	-	-	-	-	-	-
	8	5~8	-	-	-	-	-	-	-	-	-	-	-	-	-	-	-	-	-	-	-	-
	10	6~10	100	100	100	100	15	12	10	8	4	3	100	100	100	100	50	38	50	38	6	5
	13/(14)	9~13/(9~14)	100	100	50	38	10	8	6	5	4	3	100	100	100	100	50	38	42	32	6	5
	17/(18)	11~17/(13~18)	100	100	25	19	10	8	6	5	4	3	100	100	50	50	50	38	12	9	5	5
	22/(23)	14~22/(17~23)	50	38	25	19	10	8	6	5	4	3	100	100	50	50	50	38	12	9	5	5
	26/(25)	18~26/(20~25)	50	38	25	19	10	8	6	5	4	3	100	100	50	50	35	27	12	9	5	5
	32	22~32/(24~32)	50	38	25	19	10	8	6	5	4	3	100	100	50	50	35	27	10	8	5	5
	40	28~40	50	38	25	19	10	8	6	5	4	3	100	100	50	50	35	27	10	8	5	5
	50	34~50	50	38	25	19	10	8	6	5	4	3	100	100	50	50	35	27	10	8	5	5
	63	45~63	50	38	25	19	10	8	6	5	4	3	100	100	50	50	35	27	27	8	5	5
	65	47~65	50	38	25	19	10	8	6	5	4	3	75	50	35	27	25	19	6	5	3	3
	75	55~75	-	-	-	-	-	-	-	-	-	-	-	-	-	-	-	-	-	-	-	-
	90	70~90	-	-	-	-	-	-	-	-	-	-	-	-	-	-	-	-	-	-	-	-
	100	80~100	-	-	-	-	-	-	-	-	-	-	-	-	-	-	-	-	-	-	-	-

Note) Safety certification is obtained based on 220V and 460V.

Note) There is no current adjustment range for HI products. (Refer to page 15 for Model and Rating)

Product Selection Guide



Frame		100AF																				
Type	Current adjustable type	MMS-100S										MMS-100H										
	Instantaneous type	-										MMS-100HI										
Breaking capacity		Standard										High breaking										
Handle type		Rotary										Rotary										
Number of poles		3										3										
Rated operational voltage (Ue)		Up to 690V										Up to 690V										
Rated frequency		50/60 Hz										50/60 Hz										
Rated insulation voltage (Ui)		1000V										1000V										
Rated impulse voltage (Uimp)		8kV										8kV										
Utilization category IEC 60 947-2 (Breaker)		Cat. A										Cat. A										
IEC 60 947-4 (Motor starter)		AC 3										AC 3										
Mechanical endurance (Operating)		50,000										50,000										
Electrical endurance (Cycles)		25,000										25,000										
Max operating frequency per hour (Ope./h)		25										25										
Temperature compensation (Operation)		-20 ~ +60°C										-20 ~ +60°C										
Instantaneous short circuit release		13 × Ie max.										13 × Ie max.										
Overload protection		○										MMS-32H(○), MMS-32HI(×)										
Phase failure function		○										MMS-32H(○), MMS-32HI(×)										
Trip indicating function		○										○										
Test function		○										○										
Certification																						
Weight (g)		2,200																				
Rated breaking capacity (kA)	Rated operational current (Ie) / (MMS-32D)	Thermal release adjustment range (Ie) / (MMS-32D)	240V 230V 220V		415V 400V		460V 440V		525V 500V		690V 600V		240V 230V 220V		415V 400V		460V 440V		525V 500V		690V 600V	
			Icu	Ics	Icu	Ics	Icu	Ics	Icu	Ics	Icu	Ics	Icu	Ics	Icu	Ics	Icu	Ics	Icu	Ics		
	0.16	0.1~0.16	-	-	-	-	-	-	-	-	-	-	-	-	-	-	-	-	-	-	-	-
	0.25	0.16~0.25	-	-	-	-	-	-	-	-	-	-	-	-	-	-	-	-	-	-	-	-
	0.4	0.25~0.4	-	-	-	-	-	-	-	-	-	-	-	-	-	-	-	-	-	-	-	-
	0.63	0.4~0.63	-	-	-	-	-	-	-	-	-	-	-	-	-	-	-	-	-	-	-	-
	1	0.63~1	-	-	-	-	-	-	-	-	-	-	-	-	-	-	-	-	-	-	-	-
	1.6	1~1.6	-	-	-	-	-	-	-	-	-	-	-	-	-	-	-	-	-	-	-	-
	2.5	1.6~2.5	-	-	-	-	-	-	-	-	-	-	-	-	-	-	-	-	-	-	-	-
	4	2.5~4	-	-	-	-	-	-	-	-	-	-	-	-	-	-	-	-	-	-	-	-
	6/(6.3)	4~6/(4~6.3)	-	-	-	-	-	-	-	-	-	-	-	-	-	-	-	-	-	-	-	-
	8	5~8	-	-	-	-	-	-	-	-	-	-	-	-	-	-	-	-	-	-	-	-
	10	6~10	-	-	-	-	-	-	-	-	-	-	-	-	-	-	-	-	-	-	-	-
	13/(14)	9~13/(9~14)	-	-	-	-	-	-	-	-	-	-	-	-	-	-	-	-	-	-	-	-
	17/(18)	11~17/(13~18)	100	100	50	38	40	30	25	19	10	8	100	100	100	100	50	38	35	27	12	9
	22/(23)	14~22/(17~23)	100	100	50	38	40	30	25	19	10	8	100	100	100	100	50	38	35	27	12	9
	26/(25)	18~26/(20~25)	100	100	50	38	40	30	25	19	10	8	100	100	100	100	50	38	35	27	12	9
	32	22~32/(24~32)	100	100	50	38	40	30	15	11	10	8	100	100	100	100	50	38	25	19	12	9
	40	28~40	100	100	50	38	40	30	15	11	6	5	100	100	100	100	50	38	20	15	12	9
	50	34~50	100	100	50	38	40	30	12	9	6	5	100	100	100	100	50	38	15	11	10	8
63	45~63	100	100	50	38	40	30	12	9	6	5	100	100	100	100	50	38	15	11	8	6	
65	47~65	-	-	-	-	-	-	-	-	-	-	-	-	-	-	-	-	-	-	-	-	
75	55~75	100	100	50	38	40	30	8	6	5	4	100	100	75	50	50	38	12	9	6	6	
90	70~90	100	100	50	38	40	30	8	6	5	4	100	100	75	50	50	38	12	9	6	6	
100	80~100	100	100	50	38	40	30	8	6	5	4	100	100	75	50	50	38	12	9	6	6	

Note) Safety certification is obtained based on 220V and 460V.

Note) There is no current adjustment range for HI products. (Refer to page 15 for Model and Rating)

Standard type

- Adjustable thermal release
- Magnetic release 13 le max.
- Trip class 10
- Protective function
- Phase-failure protection
 - Phase-failure
 - Short circuit
 - Overload



Type	Rated operational current [A]	Thermal release adjustment range [A]	Magnetic release operating current [A]	Switching of 3 phase AC motors, AC-2, AC-3						400/415V	
				3-phase [kW] (50/60Hz)			3-phase [HP] (60Hz)			Icu [kA]	Ics [kA]
				230V	400V	690V	230V	460V	575V		
MMS-32D	0.16	0.1~0.16	2.3	-	-	0.06	-	-	-	100	100
	0.25	0.16~0.25	3.6	-	0.06	0.12	-	-	-	100	100
	0.4	0.25~0.4	5.8	0.06	0.09	0.18	-	-	-	100	100
	0.63	0.4~0.63	9.1	0.09	0.18	0.25	-	-	-	100	100
	1	0.63~1	14.4	0.18	0.25	0.55	-	-	1/2	100	100
	1.6	1~1.6	23.0	0.25	0.55	1.1	-	3/4	3/4	100	100
	2.5	1.6~2.5	36.0	0.37	0.75	1.5	1/2	1	1.5	100	100
	4	2.5~4	57.6	0.75	1.5	3.0	3/4	2	3	100	100
	6.3	4~6.3	90.7	1.5	2.2	4.0	1.5	3	5	100	100
	10	6~10	144.0	2.2	4.0	7.5	3	5	7.5	100	100
	14	9~14	201.6	3.0	5.5	11	3	10	10	15	7.5
	18	13~18	259.2	4.0	7.5	15	5	10	15	15	7.5
	23	17~23	331.2	5.5	11	18.5	7.5	15	20	15	6
25	20~25	360.0	5.5	11	22	7.5	15	20	15	6	
32	24~32	460.8	7.5	15	30	10	20	25	10	6	
MMS-32S	0.16	0.1...0.16	2.1	-	0.02	-	-	-	-	100	100
	0.25	0.16...0.25	3.3	0.03	0.06	-	-	-	-	100	100
	0.4	0.25...0.4	5.2	0.06	0.09	-	-	-	-	100	100
	0.63	0.4...0.63	8.2	0.09	0.12	0.25	-	-	-	100	100
	1	0.63...1.0	13	0.12	0.25	0.55	-	1/2	1/2	100	100
	1.6	1.0...1.6	20.8	0.25	0.55	1.1	1/3	3/4	1	100	100
	2.5	1.6...2.5	32.5	0.37	0.75	1.5	1/2	1 1/2	1 1/2	100	100
	4	2.5...4.0	52	0.75	1.5	3	1	2	3	100	100
	6	4...6	78	1.5	2.2	4	1 1/2	5	5	100	100
	8	5...8	104	1.5	3	5.5	2	5	5	100	100
	10	6...10	130	3	4	7.5	3	7 1/2	10	50	38
	13	9...13	169	3	5.5	11	3	7 1/2	10	50	38
	17	11...17	221	4	7.5	11	5	10	15	20	15
	22	14...22	286	4	7.5	15	7 1/2	15	20	15	11
	26	18...26	338	5.5	11	18.5	7 1/2	15	20	15	11
32	22...32	416	7.5	15	22	10	20	30	15	11	
40	28~40	520	7.5	18.5	30	15	30	40	10	8	
MMS-63S	10	6~10	130	3	4	7.5	3	7 1/2	10	100	100
	13	9~13	169	3	5.5	11	3	7 1/2	10	50	38
	17	11~17	221	4	7.5	11	5	10	15	25	19
	22	14~22	286	4	7.5	15	7 1/2	15	20	25	19
	26	18~26	338	5.5	11	18.5	10	20	25	25	19
	32	22~32	416	7.5	15	22	10	25	30	25	19
	40	28~40	520	7.5	18.5	30	15	30	40	25	19
	50	34~50	650	11	22	45	15	40	50	25	19
	63	45~63	819	15	30	55	20	50	60	25	19
	65	47~65	845	15	30	55	20	50	60	25	19
MMS-100S	17	11~17	221	4	7.5	11	5	10	15	50	38
	22	14~22	286	4	7.5	15	7 1/2	15	20	50	38
	26	18~26	338	5.5	11	18.5	10	20	25	50	38
	32	22~32	416	7.5	15	22	10	25	30	50	38
	40	28~40	520	7.5	18.5	30	15	30	40	50	38
	50	34~50	650	11	22	45	15	40	50	50	38
	63	45~63	819	15	30	55	20	50	60	50	38
	75	55~75	975	22	37	63	25	60	75	50	38
90	70~90	1170	30	45	75	30	75	100	50	38	
100	80~100	1300	30	45	90	40	75	100	50	38	

Model and Rating

High breaking type

- Adjustable thermal release
- Magnetic release 13 le max.
- Trip class 10
- Protective function
- Phase-failure protection
 - Phase-failure
 - Short circuit
 - Overload

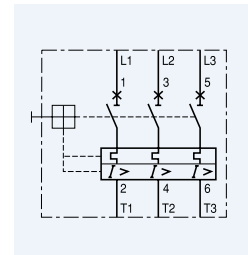

MMS-32H

MMS-63H

MMS-100H

Circuit diagram

Type	Rated operational current Ie [A]	Thermal release adjustment range [A]	Magnetic release operating current [A]	Switching of 3 phase AC motors, AC-2, AC-3						400/415V	
				3-phase [kW] (50/60Hz)			3-phase [HP] (60Hz)			Icu [kA]	Ics [kA]
				230V	400V	690V	230V	460V	575V		
MMS-32H	0.16	0.1...0.16	2.1	-	0.02	-	-	-	-	100	100
	0.25	0.16...0.25	3.3	0.03	0.06	-	-	-	-	100	100
	0.4	0.25...0.4	5.2	0.06	0.09	-	-	-	-	100	100
	0.63	0.4...0.63	8.2	0.09	0.12	0.25	-	-	-	100	100
	1	0.63...1.0	13	0.12	0.25	0.55	-	1/2	1/2	100	100
	1.6	1.0...1.6	20.8	0.25	0.55	1.1	1/3	3/4	1	100	100
	2.5	1.6...2.5	32.5	0.37	0.75	1.5	1/2	1½	1½	100	100
	4	2.5...4.0	52	0.75	1.5	3	1	2	3	100	100
	6	4...6	78	1.5	2.2	4	1½	5	5	100	100
	8	5...8	104	1.5	3	5.5	2	5	5	100	100
	10	6...10	130	3	4	7.5	3	7½	10	100	100
	13	9...13	169	3	5.5	11	3	7½	10	100	100
	17	11...17	221	4	7.5	11	5	10	15	50	38
	22	14...22	286	4	7.5	15	7½	15	20	50	38
	26	18...26	338	5.5	11	18.5	7½	15	20	50	38
32	22...32	416	7.5	15	22	10	20	30	50	38	
40	28~40	520	7.5	18.5	30	15	30	40	40	30	
MMS-63H	10	6~10	130	3	4	7.5	3	7½	10	100	100
	13	9~13	169	3	5.5	11	3	7½	10	100	100
	17	11~17	221	4	7.5	11	5	10	15	50	50
	22	14~22	286	4	7.5	15	7½	15	20	50	50
	26	18~26	338	5.5	11	18.5	10	20	25	50	50
	32	22~32	416	7.5	15	22	10	25	30	50	50
	40	28~40	520	7.5	18.5	30	15	30	40	50	50
	50	34~50	650	11	22	45	15	40	50	50	50
	63	45~63	819	15	30	55	20	50	60	50	50
65	47~65	845	15	30	55	20	50	60	35	27	
MMS-100H	17	11~17	221	4	7.5	11	5	10	15	100	100
	22	14~22	286	4	7.5	15	7½	15	20	100	50
	26	18~26	338	5.5	11	18.5	10	20	25	100	50
	32	22~32	416	7.5	15	22	10	25	30	100	50
	40	28~40	520	7.5	18.5	30	15	30	40	100	50
	50	34~50	650	11	22	45	15	40	50	100	50
	63	45~63	819	15	30	55	20	50	60	100	50
	75	55~75	975	22	37	63	25	60	75	75	50
90	70~90	1170	30	45	75	30	75	100	75	50	
100	80~100	1300	30	45	90	40	75	100	75	50	

Instantaneous type

- Without thermal releases
- Magnetic release 13 le max.
- Protective function
- Short circuit

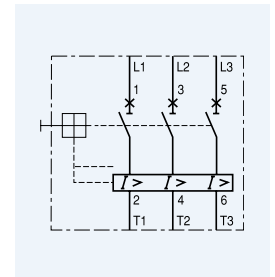

MMS-32HI

MMS-63HI

MMS-100HI

Circuit diagram

Type	Rated operational current I _e [A]	Thermal release adjustment range [A]	Magnetic release operating current [A]	Switching of 3 phase AC motors, AC-2, AC-3						400/415V	
				3-phase [kW] (50/60Hz)			3-phase [HP] (60Hz)			I _{cu} [kA]	I _{cs} [kA]
				230V	400V	690V	230V	460V	575V		
MMS-32HI	0.16	-	2.1	-	0.02	-	-	-	-	100	100
	0.25	-	3.3	0.03	0.06	-	-	-	-	100	100
	0.4	-	5.2	0.06	0.09	-	-	-	-	100	100
	0.63	-	8.2	0.09	0.12	0.25	-	-	-	100	100
	1	-	13	0.12	0.25	0.55	-	1/2	1/2	100	100
	1.6	-	20.8	0.25	0.55	1.1	1/3	3/4	1	100	100
	2.5	-	32.5	0.37	0.75	1.5	1/2	1½	1½	100	100
	4	-	52	0.75	1.5	3	1	2	3	100	100
	6	-	78	1.5	2.2	4	1½	5	5	100	100
	8	-	104	1.5	3	5.5	2	5	5	100	100
	10	-	130	3	4	7.5	3	7½	10	100	100
	13	-	169	3	5.5	11	3	7½	10	100	100
	17	-	221	4	7.5	11	5	10	15	50	38
	22	-	286	4	7.5	15	7½	15	20	50	38
	26	-	338	5.5	11	18.5	7½	15	20	50	38
32	-	416	7.5	15	22	10	20	30	50	38	
MMS-63HI	10	-	130	3	4	7.5	3	7½	10	100	100
	13	-	169	3	5.5	11	3	7½	10	100	100
	17	-	221	4	7.5	11	5	10	15	50	50
	22	-	286	4	7.5	15	7½	15	20	50	50
	26	-	338	5.5	11	18.5	10	20	25	50	50
	32	-	416	7.5	15	22	10	25	30	50	50
	40	-	520	7.5	18.5	30	15	30	40	50	50
	50	-	650	11	22	45	15	40	50	50	50
	63	-	819	15	30	55	20	50	60	50	50
65	-	845	15	30	55	20	50	60	35	27	
MMS-100HI	17	-	221	4	7.5	11	5	10	15	100	100
	22	-	286	4	7.5	15	7½	15	20	100	50
	26	-	338	5.5	11	18.5	10	20	25	100	50
	32	-	416	7.5	15	22	10	25	30	100	50
	40	-	520	7.5	18.5	30	15	30	40	100	50
	50	-	650	11	22	45	15	40	50	100	50
	63	-	819	15	30	55	20	50	60	100	50
	75	-	975	22	37	63	25	60	75	75	50
	90	-	1170	30	45	75	30	75	100	75	50
100	-	1300	30	45	90	40	75	100	75	50	

Accessories

Auxiliary contact

FX Auxiliary switch

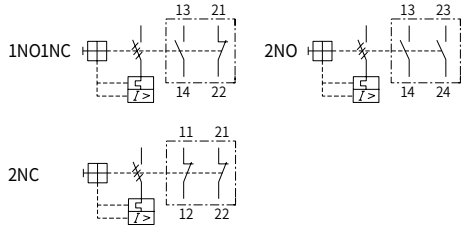
Picture	Description	Connection diagram
	<ul style="list-style-type: none"> • Front mounting • 2-pole • One front mounting module per circuit breaker 	

LX Auxiliary switch

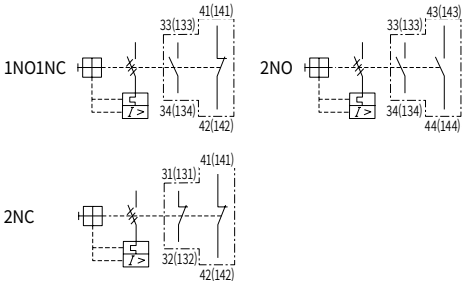
Picture	Description	Connection diagram
	<ul style="list-style-type: none"> • Side mounting on the left • 2-pole • One side mounting module per circuit breaker 	

Alarm contact

LA Any trip alarm switch 32FA, 63/100AF

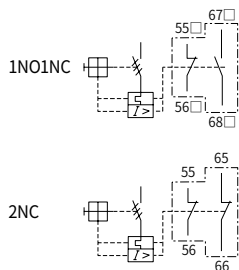
Picture	Description	Connection diagram
	<ul style="list-style-type: none"> • Operates in case of trip • Side mounting on the left • 2-pole • Set LA first in case of using LX together (MMS-63 cannot accept LX and LA together) 	

LAM Magnetic trip alarm switch

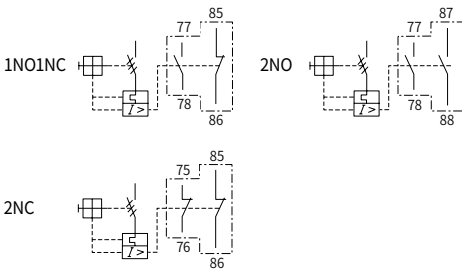
Picture	Description	Connection diagram
	<ul style="list-style-type: none"> • Short circuit trip only action • Side mounting on the left • 2-pole • Set LAM first in case of using LX together 	

Trip device

RS Shunt release

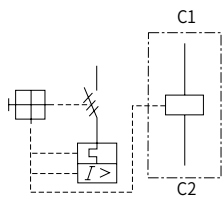
Picture	Rated voltage	Description	Connection diagram
	<ul style="list-style-type: none"> • 24V 50Hz / 28V 60Hz • 110 50Hz / 120V 60Hz • 220~230V 50Hz / 240~260V 60Hz • 240V 50Hz / 277V 60Hz • 380~400V 50Hz / 440~460V 60Hz • 415~440V 50Hz / 460~480V 60Hz 	<ul style="list-style-type: none"> • Side mounting on the right • One side mounting module per circuit breaker. • Cannot use with RU or RUX 	

RU Undervoltage release

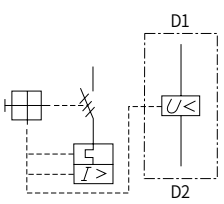
Picture	Rated voltage	Description	Connection diagram
	<ul style="list-style-type: none"> • 24V 50Hz / 28V 60Hz • 110 50Hz / 120V 60Hz • 220~230V 50Hz / 240~260V 60Hz • 240V 50Hz / 277V 60Hz • 380~400V 50Hz / 440~460V 60Hz • 415~440V 50Hz / 460~480V 60Hz 	<ul style="list-style-type: none"> • Side mounting on the right • One side mounting module per circuit breaker. • Cannot use with RU or RUX 	

RUX Undervoltage release with switch

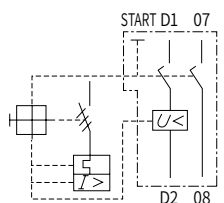
Picture	Rated voltage	Description	Connection diagram
	<ul style="list-style-type: none"> • 24V 50Hz / 28V 60Hz • 110 50Hz / 120V 60Hz • 220~230V 50Hz / 240~260V 60Hz • 240V 50Hz / 277V 60Hz • 380~400V 50Hz / 440~460V 60Hz • 415~440V 50Hz / 460~480V 60Hz 	<ul style="list-style-type: none"> • Side mounting on the right • One side mounting module per circuit breaker. • Cannot use with RU or RUX • Cannot attach to MMS-32S 	

Accessories

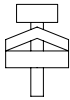

Auxiliaries

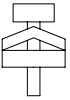
Contents		Auxiliary contacts for front mounting FX	Auxiliary contacts for front mounting LX	Alarm switch for left side mounting LA
Rated thermal current / th at 40°C ambient temperature		[A] 5	10	10
at 60°C ambient temperature		[A] 3	6	6
Contact class coordination according to NEMA (UL/CSA standards)		AC A 300 DC R 300	A 600 Q 300	A 600 Q 300
Back-up fuses gG, gL		[A] 16	16	16
Rated supply current	C-15	[V] - 240 [A] - 3	24 240 6 4	24 240 6 4
	DC-13:	[V] 24 220	24 220	24 220
		[A] 1 0.1	2 0.25	2 0.25
Weight (g)		18	30	40
Terminal parts				
Wire				
Single-core	1 conductor	[mm²] / [AWG] 0.5...2.5 / 20...14		Pozidriv size 2 0.5...2.5 / 20...14
	2 conductor	[mm²] / [AWG] -		0.5...2.5 / 20...14
Stranded	1 conductor	[mm²] / [AWG] 0.5...4 / 20...10		0.5...4 / 20...10
	2 conductor	[mm²] / [AWG] 0.75...2.5 / 18...14		0.75...2.5 / 18...14
Tightening torque		[Nm] / [lb-in] 0.8...1.2 / 7...10		0.8...1.2 / 7...10

Contents		Shunt release for right side mounting RS	Undervoltage release for right side mounting RU	Undervoltage release with 2 auxiliary contacts for right side mounting RUX
Actuating voltage(V)				
Pull-in		0.85...1.1×Us	0.7...1.1×Us	0.85...1.1×Us
Drop-out		0.7...0.35×Us		0.7...0.35×Us
Rated control voltage(V)				
min.:		24V 50Hz / 28V 60Hz	24V 50Hz / 28V 60Hz	24V 50Hz / 28V 60Hz
max.:		415~440V 50Hz / 460~480V 60Hz	415~440V 50Hz / 460~480V 60Hz	415~440V 50Hz / 460~480V 60Hz
Coil rating(W)				
Pull-in		8.5VA, 6W	8.5VA, 6W	8.5VA, 6W
Hold		3VA, 1.2W	3VA, 1.2W	3VA, 1.2W
Opening time (ms)		20	-	20
Weight (g)		120	110	110
Terminal parts				
Wire				
Single-core	1 conductor	[mm²] / [AWG] 0.5...2.5 / 20...14		Pozidriv size 2 0.5...2.5 / 20...14
	2 conductor	[mm²] / [AWG] -		0.5...2.5 / 20...14
Stranded	1 conductor	[mm²] / [AWG] 0.5...4 / 20...10		0.5...4 / 20...10
	2 conductor	[mm²] / [AWG] 0.75...2.5 / 18...14		0.75...2.5 / 18...14
Tightening torque		[Nm] / [lb-in] 0.8...1.2 / 7...10		0.8...1.2 / 7...10

Auxiliary contact

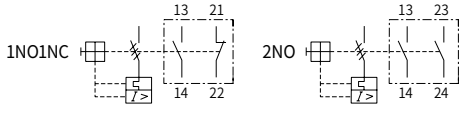
Auxiliary switch

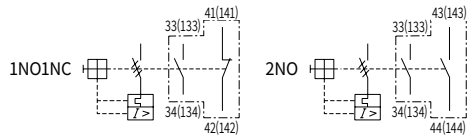
Picture	Model	Description	Connection diagram
	FXN-11	<ul style="list-style-type: none"> • Front mounting • Only 1 unit can be installed 	
	FXN-20		
	LXN-11	<ul style="list-style-type: none"> • Side mounting on the left • 2 LXN can be installed together 	
	LXN-20		

Magnetic trip alarm switch

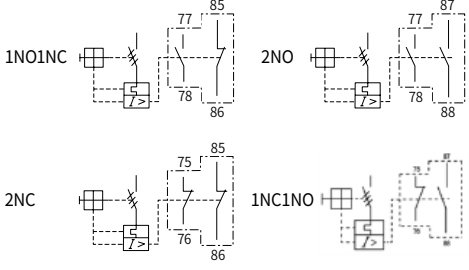
Picture	Model	Description	Connection diagram
	LAMN-1001	<ul style="list-style-type: none"> • Side mounting on the left • Only 1 unit can be installed 	
	LAMN-1010		
	LAMN-0101		
	LAMN-0110		

Accessories(MMS-32D)

Shunt release

Shunt release

Picture	Model	Rated voltage	Description
	RSN110	110~127V 50/60Hz	<ul style="list-style-type: none"> • Side mounting on the right • Either one shunt or undervoltage release can be installed.
	RSN220	220~240V 50/60Hz	
	RSN380	380~415V 50/60Hz	

Undervoltage release

Undervoltage release

Picture	Model	Rated voltage	Description
	RUN110	110~127V 50/60Hz	<ul style="list-style-type: none"> • Side mounting on the right • Either one shunt or undervoltage release can be installed.
	RUN220	220~240V 50/60Hz	
	RUN380	380~415V 50/60Hz	

Installation of accessories

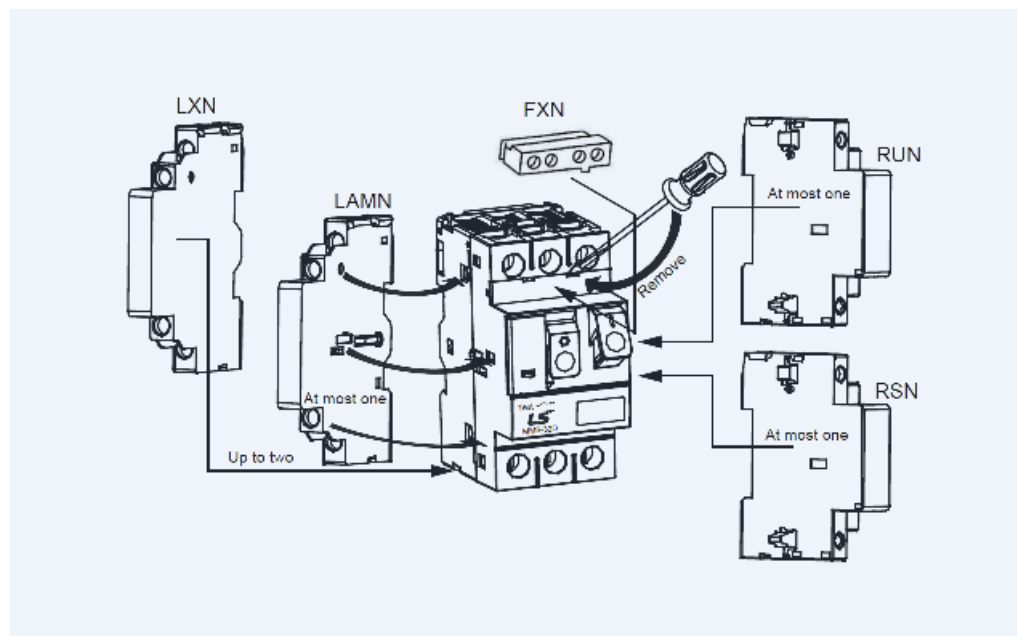

Electrical auxiliaries

E-handle (Rotary-type)



MMS E-Handle is a Rotary-type Handle accessory which can be attached to the front to control and verify the ON, TRIP and OFF condition of Manual Motor Starters based on situation of closing panel.

- Application model : MMS-32H/HI, 63S/H/HI, 100S/H/HI
- Operation temp : -20 ~ +60°C
- CE and UL certified
- Degree of protection : IP65(UL Type1, Type3R)
- Locking device : Lockable in on/off position
- Material of insulation : Plastic(PA66)

Type	Application MMS	Notes
MEH-32	MMS-32H, 32HI	Length of shaft : 115 or 315mm
MEH-63	MMS-63S, 63H, 63HI	
MEH-100	MMS-100S, 100H, 100HI	

Phase bus system



This device is for parallel connection with power terminals in the circuit lined up by MMS, offering simplified wiring with compact wiring space.

- Application model : MMS-32, 63
- Safety cover built-in
- CE and UL certified
- RoHS compliance

Type	Application MMS	Number of terminals	Rated current	Safety cover attached
PB-322	MMS-32S, 32H, 32HI	2 (MMS 2)	63A	PBPC-32
PBL-322	MMS-32S, 32H, 32HI with Aux (LX or LA or LAM)	2 (MMS 2)		
PB-323	MMS-32S, 32H, 32HI	3 (MMS 3)		
PBL-323	MMS-32S, 32H, 32HI with Aux (LX or LA or LAM)	3 (MMS 3)		
PB-324	MMS-32S, 32H, 32HI	4 (MMS 4)		
PB-325	MMS-32S, 32H, 32HI	5 (MMS 5)		
PB-632	MMS-63S, 63H, 63HI	2 (MMS 2)	108A	PBPC-63
PB-633	MMS-63S, 63H, 63HI	3 (MMS 3)		

Accessories

Electrical auxiliaries

Line terminal block



Lug type is installed for convenient wiring.

Model	LTB-32
Pole	3P
Mounting location	Upstream
IP degree of protection	IP20 according to IEC 60529
Rated insulation voltage (Ui)	690V according to IEC 60947-1
Rated operational current (Ie)	63A
Terminal torque	1.7 N.m- on screw clamp terminals

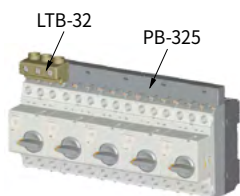

Diagram

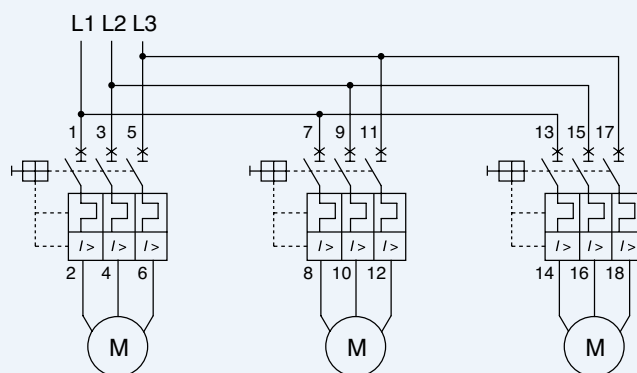

Terminal block (TB-32)



This accessory device ensures insulation distance between phases.

When this device is used, it meets the requirements of UL Combination Motor Controller Type E.

- Application model : MMS-32H, MMS-32HI

Dial cover

Dial cover is used to protect the set value from unintended operation and tampering.

- Application Model : MMS-32, 63,100 (All types)

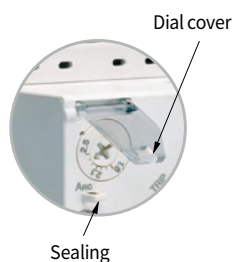

Enclosure



The MMS enclosure case cover is dust-proof and corrosion-proof. The case cover is designed for use in dust-filled areas such as cement plants, cotton mills as well as in the presence of corrosive gas or liquids (excluding explosive or flammable gas) such as fertilizer, refinery and plating plants.

- Application Model : MMS-32
- Operation temp : -20 ~ +60°C
- Degree of protection : IP65
- Material of insulation :Plastic(ABS)
- CE and UL certified

Type	Application MMS	Notes
EPH-32	MMS-32H, 32HI	Surface mount

Insulation barrier



Insulation barrier is used to enlarge creepage distance and clearance to meet UL requirements.

- Application Model : MMS-100

Type	Application MMS
IB100	MMS-100S, 100H, 100HI

Screw mounting holder

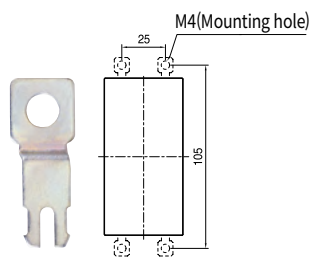

32AF MMS is only for DIN rail mounting by itself. The screw mounting holder is used to mount MMS on a panel via screws.

- Application Model : MMS-32

Type	Application MMS	Notes
MP-32	MMS-32S, 32H, 32HI	For M4 screw

Accessories

Electrical auxiliaries

Direct adaptor and mounting unit

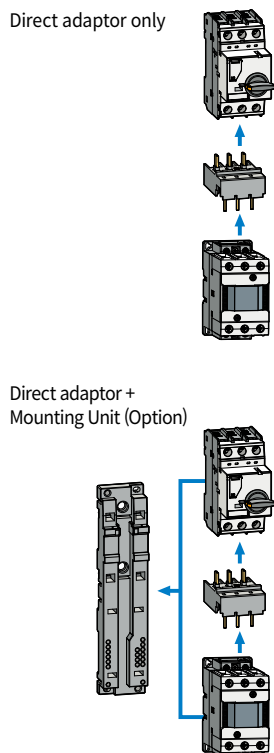

Direct adaptor, DA

The direct adaptor is used to connect the MMS directly with a contactor.

Mounting unit, MU

This device is an attachment module to connect joined MMS with a contactor.

• Application Model : MMS+Susol MC (MC-9~95), Mini MC

Direct adaptor		Mounting unit	Combined devices	Applying contactor	
Frame	Name				
DA-16	DA-16SA	MU-45	MMS-32S + GMC-6M~16M	Mini-MC	
	DA-16SD		MMS-32S + GMD-6M~16		
	DA-16HA		MMS-32H + GMC-6M~16M		
	DA-16HD		MMS-32H + GMD-6M~16M		
DA-18	DA-18SA		MMS-32S + MC-6a~18a	Metasol MC	
	DA-18SD		MMS-32S + MC-6a~18a DC		
	DA-18HA		MMS-32H + MC-6a~18a		
	DA-18HD		MMS-32H + MC-6a~18a DC		
DA-22	DA-22SA		MMS-32S + MC-9b~22b		Susol, Metasol MC
	DA-22SD		MMS-32S + MC-9b~22b DC		
	DA-22HA		MMS-32H + MC-9b~22b		
	DA-22HD		MMS-32H + MC-9b~22b DC		
DA-32	DA-32SA		MMS-32S + MC-9~32(32a, 40a)	Susol, Metasol MC	
	DA-32SD		MMS-32S + MC-9~32(32a, 40a) DC		
	DA-32HA		MMS-32H + MC-9~32(32a, 40a)		
	DA-32HD		MMS-32H + MC-9~32(32a, 40a) DC		
DA-63	DA-63A	MMS-63AF + MC-35~63 (50a, 65a)	Susol, Metasol MC (Lug type only)		
	DA-63D	MMS-63AF + MC-35~63 (50a, 65a) DC			
DA-95A	DA-95A	MMS-100AF + MC-65~95 (75a, 85a, 100a)			
	DA-95D	MMS-100AF + MC-65~95 (75a, 85a, 100a) DC			

Possible combination chart

Please read this chart completely before installing auxiliaries.



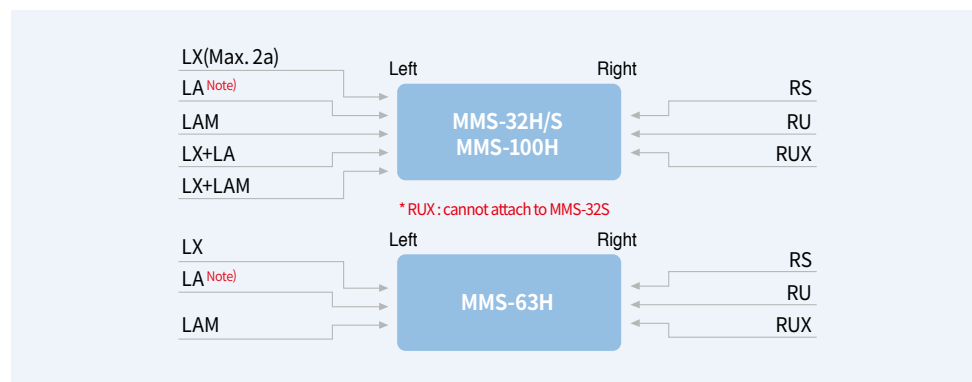

Improper combination can cause electric failure or accident.



Note: LA (32 on 63/100 are separate).

Installation and use environment

Terminals

Contents		MMS-32S	MMS-32H	MMS-63S, 63H	MMS-100S, 100H
Conformity to standards		IEC60947-2, IEC60947-4-1 UL508, UL508 Type E (except MMS-32S)			
Approvals		CE, UL			
Terminal parts					
Wire					
Single-core	1 conductor	[mm ²] / [AWG] 1...10 / 18...8	1...10 / 18...8	0.75...35 / 18...2	2.5...70 / 12...2/0
	2 conductor	[mm ²] / [AWG] 1...6 / 18...10	1...6 / 18...10	0.75...25 / 18...4	2.5...50 / 12...1/0
Stranded	1 conductor	[mm ²] / [AWG] 1...6 / 18...10	1...6 / 18...10	0.75...35 / 18...2	2.5...70 / 12...2/0
	2 conductor	[mm ²] / [AWG] 1...6 / 18...10	1...6 / 18...10	0.75...25 / 18...4	2.5...50 / 12...1/0
Flexible	1 conductor	[mm ²] / [AWG] 1...6 / 18...10	1...6 / 18...10	0.75...25 / 18...4	2.5...50 / 12...1/0
	2 conductor	[mm ²] / [AWG] 0.75...4 / 18...10	0.75...4 / 18...10	0.75...16 / 18...6	2.5...35 / 10...2
Tightening torque		[Nm] / [lb-in] 0.8...2.5 / 7...22	0.8...2.5 / 7...22	3...4.5 / 26...39	4...6 / 35...53

Power consumption

Contents	MMS-32S	MMS-32H	MMS-63S, 63H	MMS-100S, 100H
Total power loss pv circuit breaker at rated load operating temperature [W]	In = 0.16~1.6A : 4.4 In = 2.5~26A : 7.4 In = 32A : 4.0 In = 40A : 7.4	In = 0.16~1.6A : 4.4 In = 2.5~26A : 7.4 In = 32A : 4.0 In = 40A : 7.4	In = 10~22A : 10.2 In = 26~65A : 9.7	In = 17~32A : 15 In = 40~63A : 21.8 In = 75~100A : 17.8

Installation and use method

Mounting

- 35mm DIN rail for MMS32~63
- 35mm or 75mm DIN rail for MMS100
- Use 15mm depth for 35mm DIN rail

Environment

- Ambient air temperature
 - Storage : - 50 ~ 80°C
 - Operation : - 20 ~ 60°C
- Ambient temperature compensation : - 5 ~ +40 °C
- Maximum operating altitude : 2000m
- Degree of protection: IP20
- Shock resistance : 25g
- Vibration resistance : 5~150Hz

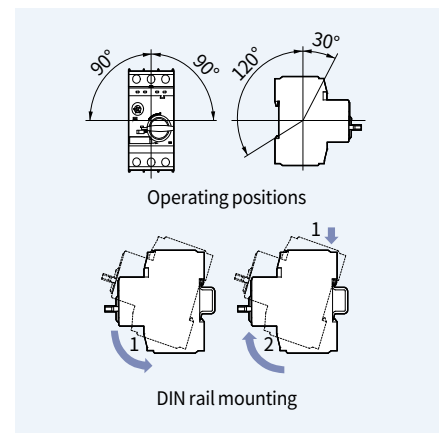

Caution for thermal adjustments

1. Keep the setting range as shown below.
2. Moving counterclockwise out of the setting range may cause damage to the device.
3. Calibration by ambient air temperature

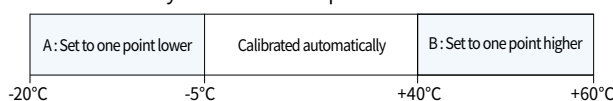

* Operation outside of standard air temperature range (-5°C~+40°C) needs calibration by one point

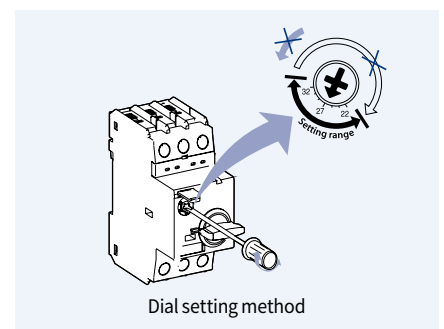

Installation of auxiliaries

MMS-32S/H/HI

Note:
Refer to page 17 for MMS-32D
Installation of auxiliaries.

Be sure to turn off the MMS main switch before any action.

- To install FX remove the cover ❶ first.
- 2 LX can be installed together.
- Only one auxiliary among RU, RS and RUX can be mounted on the right side of MMS.
- Do not apply trip signal to RS longer than 10 sec.
- Refer to the possible combination chart for the mounting of LX, LA and LAM on left side of MMS.
- Push the trip button before installation of LAM
- Do not operate the alarm contact point (LA) when the operation switch is in the trip position.
- Remove the indicated part in the fig. before the additional installation of LX
- Be sure to turn off the MMS main switch before separation.
- Softly push the separation button on the side of the auxiliary and pull it.

• Make sure to choose proper LA before use because LA for MMS-32 and MMS-63/100 are different.

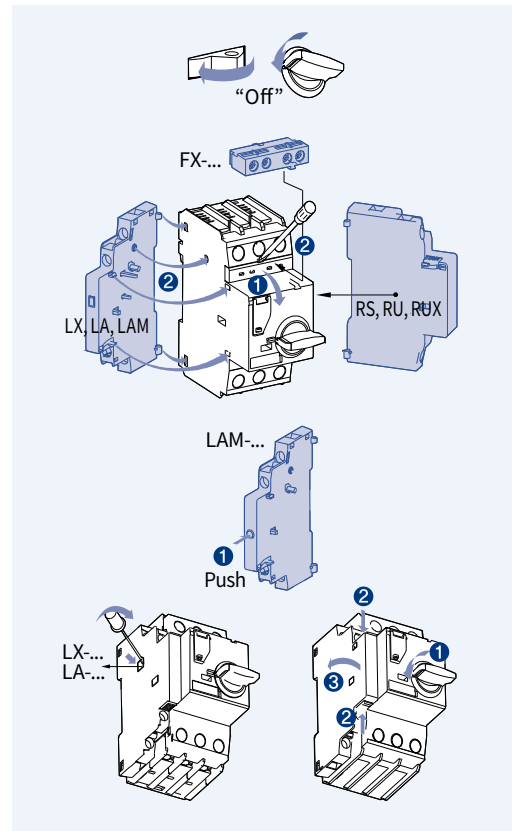

MMS-63, 100S/H/HI

- To install FX remove the cover ❶ first.
- 2 LX can be installed together.
(only 1 each for MMS-63)
- Only one auxiliary among RU, RS and RUX can be mounted on the right side of MMS.
- Do not apply trip signal to RS longer than 10 sec.
- Refer to the possible combination chart for the mounting of LX, LA and LAM on left side of MMS.
- Do not use with LA-... (32) It is only for MMS-32.
- Push the trip button before installation of LAM
- Do not install LA with MMS-100 in TRIP status
- Remove the indicated part as shown in the above fig. before the additional installation of LX
- Be sure to turn off the MMS main switch before separation.
- Softly push the separation button on the side of the auxiliary and pull it.

• Make sure to choose proper LA before use because LA for MMS-32 and MMS-63/100 are different.

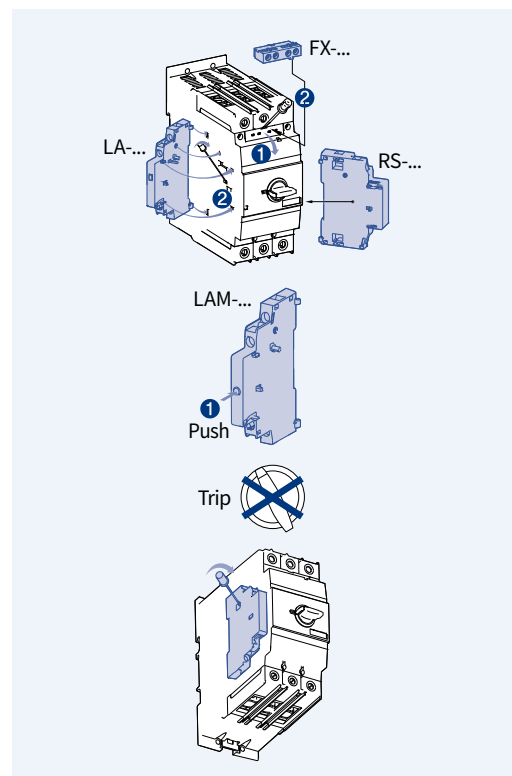

How to Install and reset RUX

Installing

- (1) Check if the trip button of RUX is "UP". If not, push the side lever ❶ or proper setting.
- (2) Fit both lower hooks ❷ into the MMS.
- (3) Rotate the handle of MMS to the 20-30 degrees ❸ to on direction and keep the setting.
- (4) Fit both upper hooks ❹ into the MMS.
- (5) Input power to the RUX.
- (6) Turn on the MMS handle.

Resetting

The trip button of RUX does not come "UP" in the event of tripping due to undervoltage.

To turn on the MMS after tripping ❶ turn off the MMS and check if the trip button of RUX comes "UP".

- ❷ push the trip button ❸ to turn on the MMS

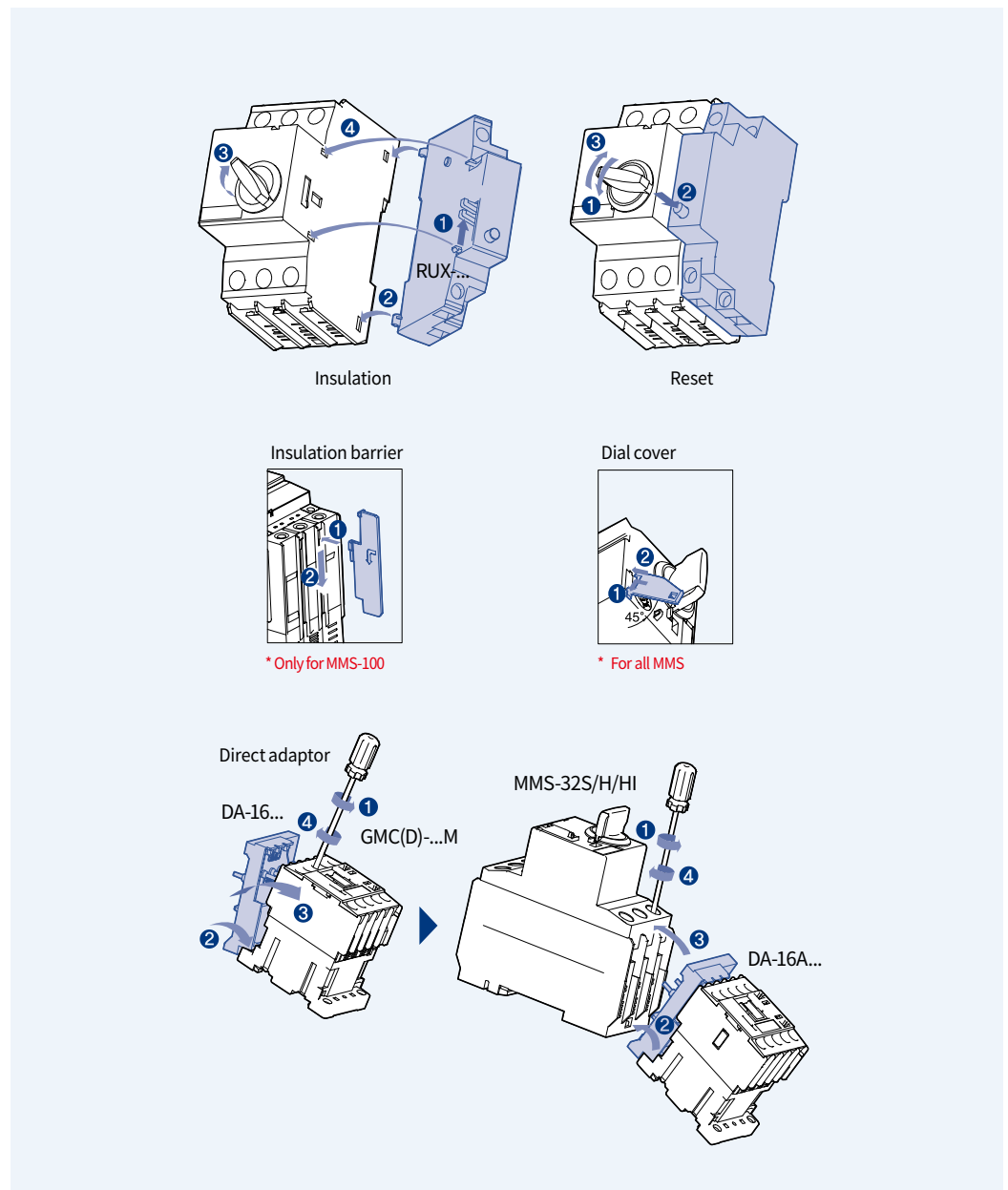

Technical Information

Installation of auxiliaries

E-handle structure

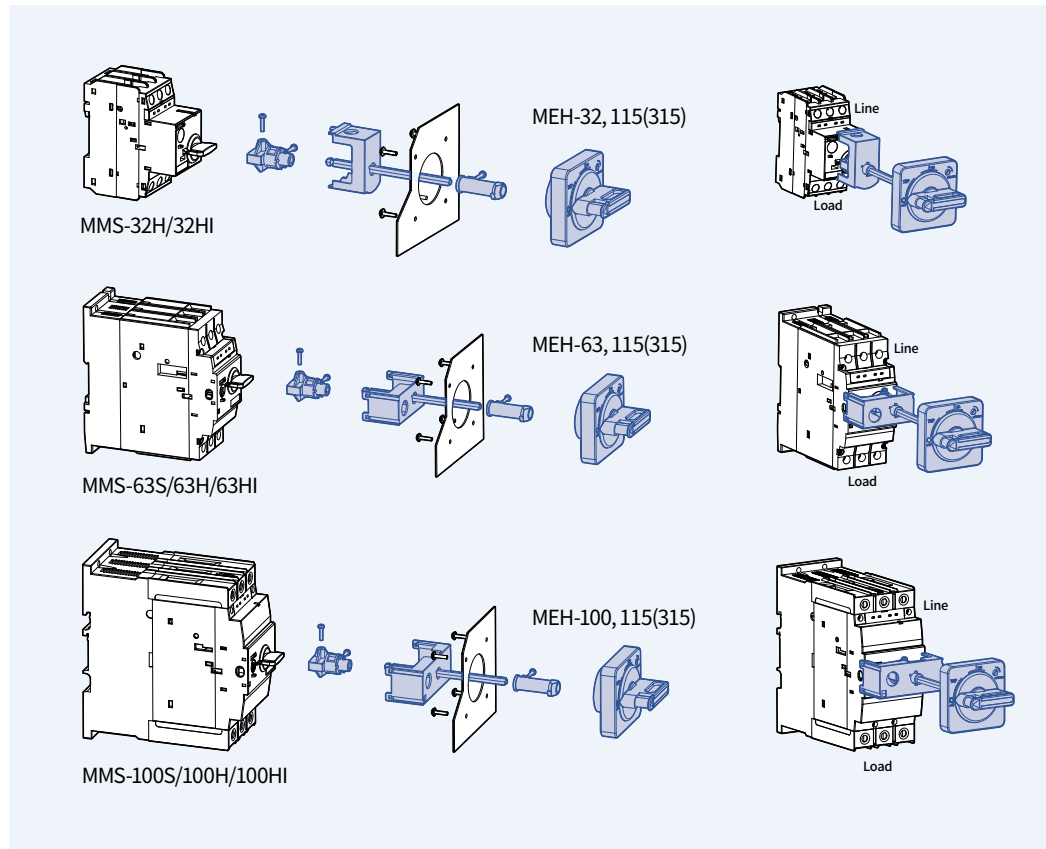

E-handle locking device

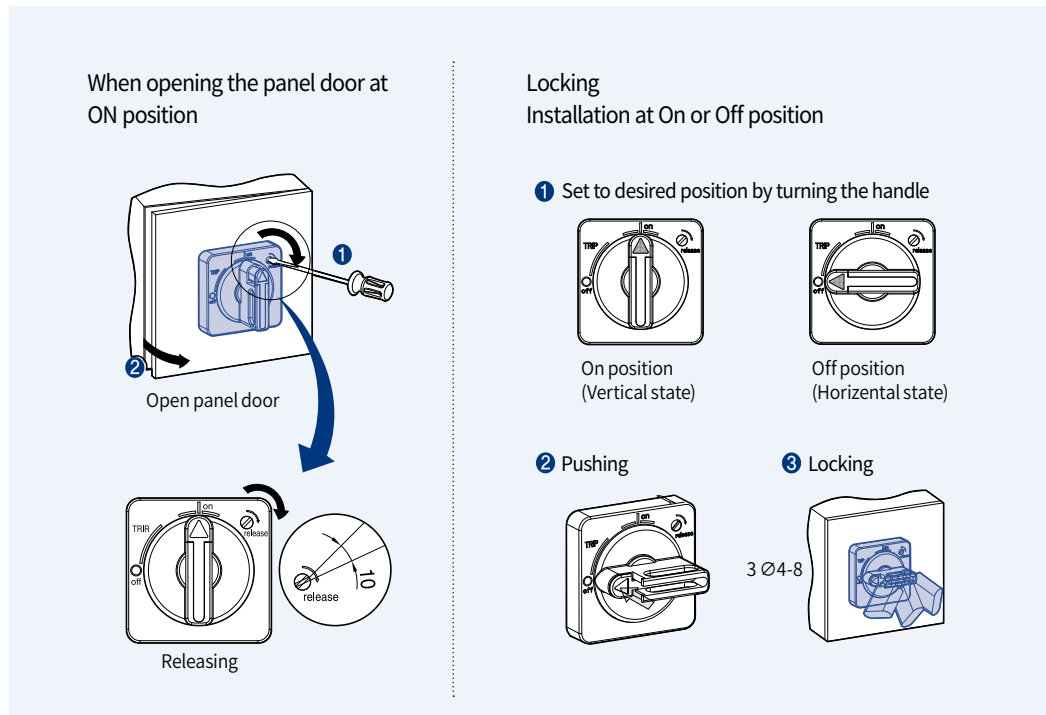

E-handle installation

The diagrams illustrate the installation of the E-handle for three different motor starter models:

- MEH-32/63/100:** Shows the handle assembly being inserted into the motor starter body. A screwdriver is used to tighten the handle, with a torque specification of 7kgf.cm.
- MEH-32:** Shows the handle being inserted into the motor starter body. A note indicates that the rod should pass through the hole when assembling.
- MEH-63/100:** Shows the handle being inserted into the motor starter body. A note indicates that the rod should pass through the hole when assembling. A torque specification of 7kgf.cm is also shown.

Additional diagrams show the handle being installed into the main cover of the motor starter. For the MEH-63/100 model, a 'Click' sound is indicated when the handle is properly seated, and a 'Caution' symbol is present.

Assembly restrictions
 Assembling is available for MMS-63/100 with 4 holes on the main cover which was produced after June 2007 based on manufacturing date.

E-handle operating test

The diagrams illustrate the operating test for the E-handle in three positions:

- Reset:** The handle is rotated to the 'Reset' position (1).
- On:** The handle is rotated to the 'On' position (2). A note states: "At On position Panel door cannot be opened".
- Off:** The handle is rotated to the 'Off' position (3). A note states: "At Trip position Panel door cannot be opened. At Off position Panel door can be opened".

Caution: Locking knob can be damaged when opening the door at ON or TRIP position.

Technical Information

Installation of auxiliaries

[mm]

E-handle
cutting off the shaft
and applying the
handle

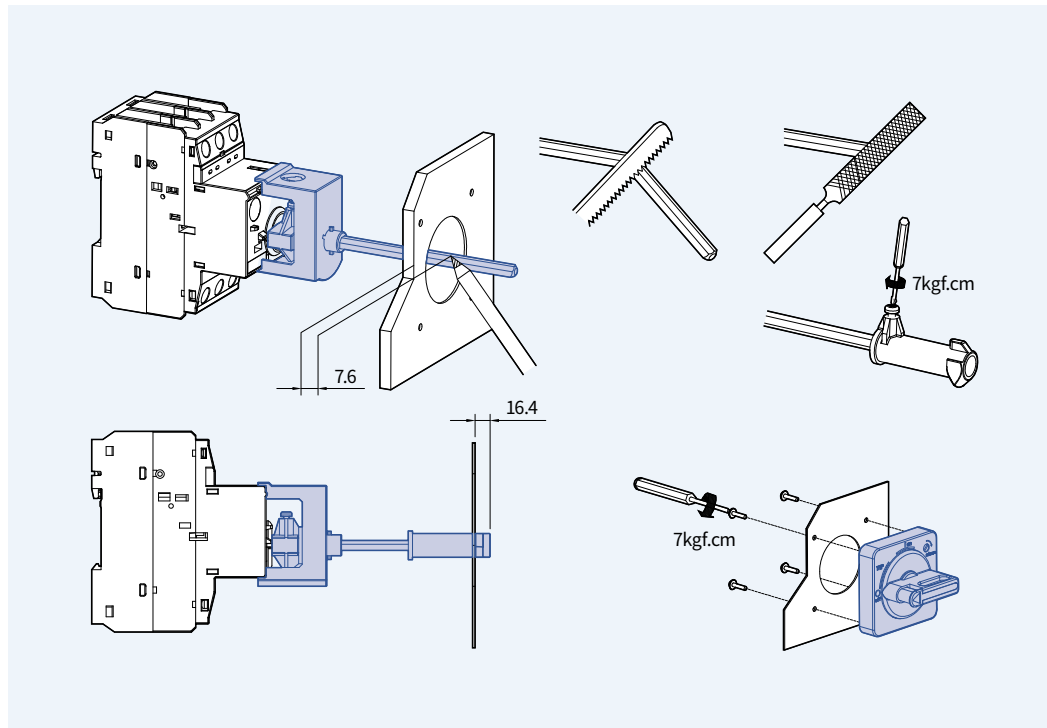

Enclosure

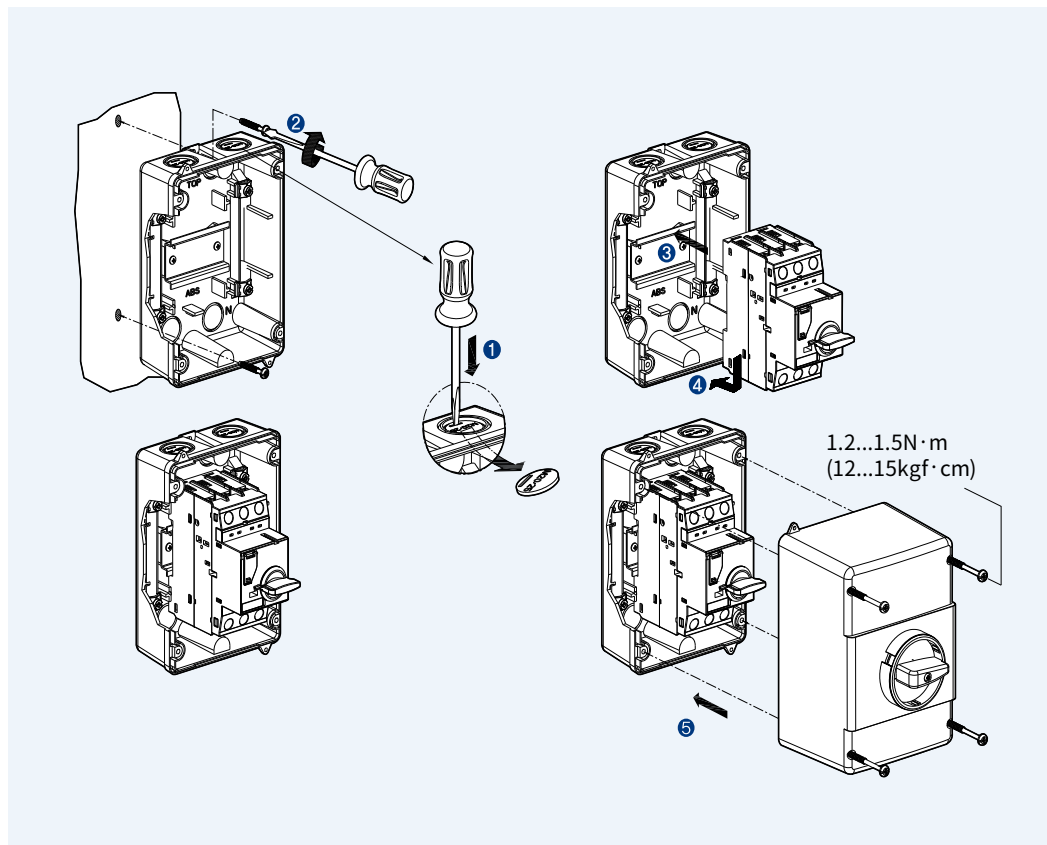

IEC performance data (Motor protection)

Standard type MMS-32S

Rated operational current Ie	0.16	0.25	0.4	0.63	1	1.6	2.5	4	6	8	10	13	17	22	26	32	40
Switching of standard three-phase motors AC-2, AC-3																	
230/240V [kW]	-	0.03	0.06	0.09	0.12	0.18/0.25	0.37	0.55/0.75	1.1/1.5	1.5	2.2/3	3	3.7/4	4	5.5	7.5	7.5
400/415V [kW]	0.02	0.06	0.09	0.12	0.18/0.25	0.37/0.55	0.75	1.1/1.5	2.2	3	3.7/4	5.5	7.5	7.5	22	15	18.5
500V [kW]	-	-	-	0.25	0.25	0.55/0.75	1.1	1.5/2.2	3	3.7	4/5.5	7.5	11	11	15	18.5	22
690V [kW]	-	-	-	0.25	0.37/0.55	0.75/1.1	1.5	2.2/3	3.7/4	5.5	7.5	11	11	11	18.5	22	30
Back-up fuses gG, gL, only if Icc>Icu (* = No back up fuse required)																	
230/240V [kA]	*	*	*	*	*	*	*	*	*	*	*	*	*	125	125	125	125
400/415V [kA]	*	*	*	*	*	*	*	*	*	*	80	80	100	100	100	100	100
400/460V [kA]	*	*	*	*	*	*	*	50	50	63	63	80	80	100	100	100	100
500V [kA]	*	*	*	*	*	*	50	40	50	63	63	80	80	80	80	80	80
690V [kA]	*	*	*	*	*	20	35	40	50	63	63	63	63	63	63	63	63
Ultimate short-circuit breaking capacity Icu																	
230/240V [kA]	100	100	100	100	100	100	100	100	100	100	100	100	50	40	40	30	20
400/415V [kA]	100	100	100	100	100	100	100	100	100	100	50	50	20	15	15	15	10
440/460V [kA]	100	100	100	100	100	100	100	50	15	15	15	10	10	8	8	6	5
500V [kA]	100	100	100	100	100	100	50	15	10	10	6	6	6	6	6	5	4
690V [kA]	100	100	100	100	100	3	3	3	3	3	3	3	3	3	3	3	2
Rated service short-circuit breaking capacity Ics																	
230/240V [kA]	100	100	100	100	100	100	100	100	100	100	100	100	38	30	30	22	15
400/415V [kA]	100	100	100	100	100	100	100	100	100	100	38	38	15	11	11	11	8
440/460V [kA]	100	100	100	100	100	100	100	38	11	11	11	8	8	6	6	4	3
500V [kA]	100	100	100	100	100	100	38	11	8	8	5	5	5	5	5	4	3
690V [kA]	100	100	100	100	100	3	3	3	3	3	3	3	3	3	3	3	2

Standard type MMS-63S

Rated operational current Ie	10	13	17	22	26	32	40	50	63	65
Switching of standard three-phase motors AC-2, AC-3										
230/240V [kW]	2.2/3	3	3.7/4	4	5.5	7.5	7.5	11	15	15
400/415V [kW]	3.7/4	5.5	7.5	7.5	11	15	18.5	22	30	30
500V [kW]	4.5/5	7.5	11	11	15	18.5	22	30	37	37
690V [kW]	7.5	11	11	15	18.5	22	30	45	55	55
Back-up fuses gG, gL, only if Icc>Icu (* = No back up fuse required)										
230/240V [kA]	*	*	*	125	125	160	160	160	200	200
400/415V [kA]	*	80	100	125	125	125	160	160	160	160
400/460V [kA]	80	80	100	100	100	100	100	100	125	125
500V [kA]	80	80	80	80	80	80	80	80	80	80
690V [kA]	63	63	63	63	63	63	63	63	80	60
Ultimate short-circuit breaking capacity Icu										
230/240V [kA]	100	100	100	50	50	50	50	50	50	50
400/415V [kA]	100	50	25	25	25	25	25	25	25	25
440/460V [kA]	15	10	10	10	10	10	10	10	10	10
500V [kA]	10	6	6	6	6	6	6	6	6	6
690V [kA]	4	4	4	4	4	4	4	4	4	4
Rated service short-circuit breaking capacity Ics										
230/240V [kA]	100	100	100	38	38	38	38	38	38	38
400/415V [kA]	100	83	19	19	19	19	19	19	19	19
440/460V [kA]	12	8	8	8	8	8	8	8	8	8
500V [kA]	8	5	5	5	5	5	5	5	5	5
690V [kA]	3	3	3	3	3	3	3	3	3	3

Standard type MMS-100S

Rated operational current Ie	17	22	26	32	40	50	63	75	90	100
Switching of standard three-phase motors AC-2, AC-3										
230/240V [kW]	3.7/4	4	5.5	7.5	7.5	11	15	22	30	30
400/415V [kW]	7.5	7.5	11	15	18.5	22	30	37	45	45
500V [kW]	11	11	15	18.5	22	30	37	45	55	63
690V [kW]	11	15	18.5	22	30	45	55	63	75	90
Back-up fuses gG, gL, only if Icc>Icu (* = No back up fuse required)										
230/240V [kA]	*	*	*	*	*	*	*	*	*	*
400/415V [kA]	100	125	125	125	160	160	160	160	160	160
400/460V [kA]	100	125	125	125	125	160	160	160	160	160
500V [kA]	100	100	100	100	100	100	100	125	125	125
690V [kA]	63	80	80	80	80	80	80	100	125	125
Ultimate short-circuit breaking capacity Icu										
230/240V [kA]	100	100	100	100	100	100	100	100	100	100
400/415V [kA]	50	50	50	50	50	50	50	50	50	50
440/460V [kA]	40	40	40	40	40	40	40	40	40	40
500V [kA]	25	25	25	15	15	12	12	8	8	8
690V [kA]	10	10	10	10	6	6	6	5	5	5
Rated service short-circuit breaking capacity Ics										
230/240V [kA]	100	100	100	100	100	100	100	100	100	100
400/415V [kA]	38	38	38	38	38	38	38	38	38	38
440/460V [kA]	30	30	30	30	30	30	30	30	30	30
500V [kA]	19	19	19	11	11	9	9	6	6	6
690V [kA]	8	8	8	8	5	5	5	4	4	4

Technical Information

IEC performance data (Motor protection)

High breaking type MMS-32H

Rated operational current Ie	0.16	0.25	0.4	0.63	1	1.6	2.5	4	6	8	10	13	17	22	26	32	40	
Switching of standard three-phase motors AC-2, AC-3																		
230/240V [kW]	-	0.03	0.06	0.09	0.12	0.18/0.25	0.37/0.55	0.55/0.75	1.1/1.5	1.5	2.2/3	3	3.7/4	5.5	7.5	11	15	18.5
400/415V [kW]	0.02	0.06	0.09	0.12	0.18/0.25	0.37/0.5	0.55/0.75	1.1/1.5	2.2	3	3.7/4	5.5	7.5	11	15	22	30	37
500V [kW]	-	-	-	0.25	0.37	0.55/0.75	1.1	1.5/2.2	3	3.7	4/5.5	7.5	11	15	22	30	37	45
690V [kW]	-	-	-	0.25	0.37/0.55	0.75/1.1	1.5	2.2/3	3.7/4	5.5	7.5	11	15	22	30	37	45	55
Back-up fuses gG, gL, only if Icc>Icu (* = No back up fuse required)																		
230/240V [kA]	*	*	*	*	*	*	*	*	*	*	*	*	*	*	*	*	*	*
400/415V [kA]	*	*	*	*	*	*	*	*	*	*	*	*	100	125	125	125	160	160
400/460V [kA]	*	*	*	*	*	*	*	*	*	80	80	80	80	100	100	100	100	125
500V [kA]	*	*	*	*	*	*	*	*	*	63	80	80	80	80	80	80	80	100
690V [kA]	*	*	*	*	*	*	35	40	50	63	63	63	63	63	63	63	63	80
Ultimate short-circuit breaking capacity Icu																		
230/240V [kA]	100	100	100	100	100	100	100	100	100	100	100	100	100	100	100	100	100	100
400/415V [kA]	100	100	100	100	100	100	100	100	100	100	100	100	50	50	50	50	40	40
440/460V [kA]	100	100	100	100	100	100	100	100	100	50	50	50	25	25	25	25	15	15
500V [kA]	100	100	100	100	100	100	100	100	100	50	50	42	10	10	10	10	8	8
690V [kA]	100	100	100	100	100	100	8	8	6	6	6	6	4	4	4	4	3	3
Rated service short-circuit breaking capacity Ics																		
230/240V [kA]	100	100	100	100	100	100	100	100	100	100	100	100	100	100	100	100	100	100
400/415V [kA]	100	100	100	100	100	100	100	100	100	100	100	100	38	38	38	38	30	30
440/460V [kA]	100	100	100	100	100	100	100	100	100	38	38	38	15	15	15	15	11	11
500V [kA]	100	100	100	100	100	100	100	100	100	38	38	32	8	8	8	8	6	6
690V [kA]	100	100	100	100	100	100	8	8	6	6	6	6	4	4	4	4	3	3

High breaking type MMS-63H

Rated operational current Ie	10	13	17	22	26	32	40	50	63	65
Switching of standard three-phase motors AC-2, AC-3										
230/240V [kW]	2.2/3	3	3.7/4	4	5.5	7.5	7.5	11	15	15
400/415V [kW]	3.7/4	5.5	7.5	7.5	11	15	18.5	22	30	30
500V [kW]	4/5.5	7.5	11	11	15	18.5	22	30	37	37
690V [kW]	7.5	11	11	15	18.5	22	30	45	55	55
Back-up fuses gG, gL, only if Icc>Icu (* = No back up fuse required)										
230/240V [kA]	*	*	*	*	*	*	*	*	*	*
400/415V [kA]	*	*	100	125	125	125	160	160	160	160
400/460V [kA]	100	100	100	125	125	125	125	125	160	160
500V [kA]	100	100	100	100	100	100	100	100	100	100
690V [kA]	63	63	63	80	80	80	80	80	80	80
Ultimate short-circuit breaking capacity Icu										
230/240V [kA]	100	100	100	100	100	100	100	100	100	75
400/415V [kA]	100	100	50	50	50	50	50	50	50	35
440/460V [kA]	50	50	50	50	35	35	35	35	35	25
500V [kA]	50	42	12	12	12	10	10	10	10	6
690V [kA]	6	6	5	5	5	5	5	5	5	3
Rated service short-circuit breaking capacity Ics										
230/240V [kA]	100	100	100	100	100	100	100	100	100	50
400/415V [kA]	100	100	50	50	50	50	50	50	50	27
440/460V [kA]	38	38	38	38	27	27	27	27	27	19
500V [kA]	38	32	9	9	9	9	9	9	9	5
690V [kA]	5	5	5	5	5	5	5	5	5	3

High breaking type MMS-100H

Rated operational current Ie	17	22	26	32	40	50	63	75	90	100
Switching of standard three-phase motors AC-2, AC-3										
230/240V [kW]	3.7/4	4	5.5	7.5	11	15	15	22	30	30
400/415V [kW]	7.5	7.5	11	18.5	22	30	30	37	45	45
500V [kW]	11	11	15	22	30	37	37	45	56	63
690V [kW]	11	15	18.5	30	45	55	55	63	75	90
Back-up fuses gG, gL, only if Icc>Icu (* = No back up fuse required)										
230/240V [kA]	*	*	*	*	*	*	*	*	*	*
400/415V [kA]	*	*	*	*	*	*	*	*	*	*
400/460V [kA]	125	125	125	160	160	160	200	200	200	200
500V [kA]	100	125	125	125	160	160	160	160	160	160
690V [kA]	80	80	80	80	80	100	100	125	160	160
Ultimate short-circuit breaking capacity Icu										
230/240V [kA]	100	100	100	100	100	100	100	100	100	100
400/415V [kA]	100	100	100	100	100	100	100	75	75	75
440/460V [kA]	50	50	50	50	50	50	50	50	50	50
500V [kA]	35	35	35	35	20	15	15	12	12	12
690V [kA]	12	12	12	12	12	10	8	6	6	6
Rated service short-circuit breaking capacity Ics										
230/240V [kA]	100	100	100	100	100	100	100	100	100	100
400/415V [kA]	100	50	50	50	50	50	50	50	50	50
440/460V [kA]	38	38	38	38	38	38	38	38	38	38
500V [kA]	27	27	27	19	15	11	11	9	9	9
690V [kA]	9	9	9	9	9	8	6	6	6	6

* Short circuit proof up to 50 or 100kA. No back up fuse required.

High breaking type MMS-32HI

Rated operational current Ie	0.16	0.25	0.4	0.63	1	1.6	2.5	4	6	8	10	13	17	22	26	32	40	
AC-2, AC-3																		
230/240V [kW]	-	0.03	0.06	0.09	0.12	0.18/0.25	0.37	0.55/0.75	1.1/1.5	1.5	2.2/3	3	3.7/4	4	5.5	7.5	7.5	
400/415V [kW]	0.02	0.06	0.09	0.12	0.18/0.25	0.37/0.55	0.75	1.1/1.5	2.2	3	3.7/4	5.5	7.5	7.5	11	15	18.5	
500V [kW]	-	-	-	0.25	0.37	0.55/0.75	1.1	1.5/2.2	3	3.7	4/5.5	7.5	11	11	15	18.5	22	
690V [kW]	-	-	-	0.25	0.37/0.55	0.75/1.1	1.5	2.2/3	3.7/4	5.5	7.5	11	11	15	18.5	22	30	
Back-up fuses gG, gL, only if Icc>Icu (* = No back up fuse required)																		
230/240V [kA]	*	*	*	*	*	*	*	*	*	*	*	*	*	*	*	*	*	
400/415V [kA]	*	*	*	*	*	*	*	*	*	*	*	*	100	125	125	125	160	
400/460V [kA]	*	*	*	*	*	*	*	*	*	80	80	80	100	100	100	100	125	
500V [kA]	*	*	*	*	*	*	*	*	*	63	80	80	80	80	80	80	100	
690V [kA]	*	*	*	*	*	*	35	40	50	63	63	63	63	63	63	63	80	
Ultimate short-circuit breaking capacity Icu																		
230/240V [kA]	100	100	100	100	100	100	100	100	100	100	100	100	100	100	100	100	100	
400/415V [kA]	100	100	100	100	100	100	100	100	100	100	100	100	100	100	50	50	40	
440/460V [kA]	100	100	100	100	100	100	100	100	100	50	50	50	25	25	25	25	15	
500V [kA]	100	100	100	100	100	100	100	100	100	50	50	42	10	10	10	10	8	
690V [kA]	100	100	100	100	100	100	8	8	6	6	6	6	4	4	4	4	3	
Rated service short-circuit breaking capacity Ics																		
230/240V [kA]	100	100	100	100	100	100	100	100	100	100	100	100	100	100	100	100	100	
400/415V [kA]	100	100	100	100	100	100	100	100	100	100	100	100	38	38	38	38	30	
440/460V [kA]	100	100	100	100	100	100	100	100	100	38	38	38	15	15	15	15	11	
500V [kA]	100	100	100	100	100	100	100	100	100	38	38	32	8	8	8	8	6	
690V [kA]	100	100	100	100	100	100	8	8	6	6	6	6	4	4	4	4	3	

High breaking type MMS-63HI

Rated operational current Ie	10	13	17	22	26	32	40	50	63	65
AC-2, AC-3										
230/240V [kW]	2.2/3	3	3.7/4	4	5.5	7.5	7.5	11	15	15
400/415V [kW]	3.7/4	5.5	7.5	7.5	11	15	18.5	22	30	30
500V [kW]	4/5.5	7.5	11	11	15	18.5	22	30	37	37
690V [kW]	7.5	11	11	15	18.5	22	30	45	55	55
Back-up fuses gG, gL, only if Icc>Icu (* = No back up fuse required)										
230/240V [kA]	*	*	*	*	*	*	*	*	*	*
400/415V [kA]	*	*	100	125	125	125	160	160	160	160
400/460V [kA]	100	100	100	125	125	125	160	125	160	160
500V [kA]	100	100	100	100	100	100	100	100	100	100
690V [kA]	63	63	63	80	80	80	80	80	80	80
Ultimate short-circuit breaking capacity Icu										
230/240V [kA]	100	100	100	100	100	100	100	100	100	75
400/415V [kA]	100	100	50	50	50	50	50	50	50	35
440/460V [kA]	50	50	50	50	35	35	35	35	35	25
500V [kA]	50	42	12	12	10	10	10	10	10	6
690V [kA]	6	6	5	5	5	5	5	5	5	3
Rated service short-circuit breaking capacity Ics										
230/240V [kA]	100	100	100	100	100	100	100	100	100	50
400/415V [kA]	100	100	50	50	50	50	50	50	50	27
440/460V [kA]	38	38	38	38	27	27	27	27	27	19
500V [kA]	38	32	9	9	9	8	8	8	8	5
690V [kA]	5	5	5	5	5	5	5	5	5	3

High breaking type MMS-100HI

Rated operational current Ie	17	22	26	32	40	50	63	75	90	100
AC-2, AC-3										
230/240V [kW]	3.7/4	4	5.5	7.5	7.5	11	15	22	30	30
400/415V [kW]	7.5	7.5	11	15	18.5	22	30	37	45	45
500V [kW]	11	11	15	18.5	22	30	37	45	55	63
690V [kW]	11	15	18.5	22	30	45	55	63	75	90
Back-up fuses gG, gL, only if Icc>Icu (* = No back up fuse required)										
230/240V [kA]	*	*	*	*	*	*	*	*	*	*
400/415V [kA]	*	*	*	*	*	*	*	*	*	*
400/460V [kA]	125	125	125	160	160	160	200	200	200	200
500V [kA]	100	125	125	125	160	160	160	160	160	160
690V [kA]	80	80	80	80	80	100	100	125	160	160
Ultimate short-circuit breaking capacity Icu										
230/240V [kA]	100	100	100	100	100	100	100	100	100	100
400/415V [kA]	100	100	100	100	100	100	100	75	75	75
440/460V [kA]	50	50	50	50	50	50	50	50	50	50
500V [kA]	35	35	35	25	20	15	15	12	12	12
690V [kA]	12	12	12	12	12	10	8	6	6	6
Rated service short-circuit breaking capacity Ics										
F230/240V [kA]	100	100	100	100	100	100	100	100	100	100
400/415V [kA]	100	50	50	50	50	50	50	50	50	50
D440/460V [kA]	38	38	38	38	38	38	38	38	38	38
500V [kA]	27	27	27	19	15	11	11	9	9	6
690V [kA]	9	9	9	9	9	8	6	6	6	6

Technical Information

Manual motor controller (UL 508, CSA C22.2 as manual motor controllers)

Type E start

Combination Motor Controller: Integrates motor control and overcurrent protection in a single device.

→ Can be used independently without need for additional protection devices.

MMS-63S

Rated operational current I _e		10	13	17	22	26	32	40	50	63	65
Max. short-circuit current											
240V	[kA]	100	100	100	100	100	100	100	100	100	100
480V	[kA]	50	50	40	40	40	40	40	40	40	40
600V	[kA]	10	10	10	10	10	10	10	10	10	10
Motor load											
1Ø	115V [HP]	1/2	1/2	1	1½	2	2	3	3	5	5
	230V [HP]	1½	2	3	3	3	5	7½	10	10	10
3Ø	200V [HP]	2	3	3	5	7½	7½	10	15	20	20
	230V [HP]	3	3	5	7½	7½	10	10	15	20	20
	460V [HP]	5	7½	10	15	15	20	30	30	40	40
	575V [HP]	7½	10	15	20	20	30	30	40	60	60

MMS-100S

Rated operational current I _e		17	22	26	32	40	50	63	75	90	100
Max. short-circuit current											
240V	[kA]	100	100	100	100	100	100	100	100	100	100
480V	[kA]	50	50	50	50	50	50	40	40	40	40
600V	[kA]	10	10	10	10	10	10	10	10	10	10
Motor load											
1Ø	115V [HP]	1	1½	2	2	3	3	5	5	7½	10
	230V [HP]	3	3	3	5	7½	10	10	15	20	20
3Ø	200V [HP]	3	5	7½	7½	10	15	20	20	25	30
	230V [HP]	5	7	7½	10	10	15	20	25	30	30
	460V [HP]	10	15	15	20	30	30	40	50	60	75
	575V [HP]	15	20	20	30	30	40	60	60	75	100

MMS-32H

Rated operational current I _e		0.16	0.25	0.4	0.63	1	1.6	2.5	4	6	8	10	13	17	22	26	32	40	
Max. short-circuit current																			
240V	[kA]	100	100	100	100	100	100	100	100	100	100	100	100	100	100	100	100	100	100
480V	[kA]	65	65	65	65	65	65	65	65	65	65	65	65	30	30	30	30	30	30
600V	[kA]	25	25	25	25	25	25	25	25	25	25	25	25	10	10	10	10	10	10
Motor load																			
1Ø	115V	[HP]	-	-	-	-	-	-	1/8	1/4	1/3	1/2	1/2	1	1½	2	2	3	3
	230V	[HP]	-	-	-	-	-	1/10	1/6	1/3	1/2	1	1½	2	3	3	5	7½	7½
3Ø	200V	[HP]	-	-	-	-	-	1/2	3/4	1	2	2	3	3	5	7½	7½	10	10
	230V	[HP]	-	-	-	-	-	1/2	3/4	1½	2	3	3	5	7½	7½	10	10	10
	460V	[HP]	-	-	-	-	-	3/4	1	2	3	5	5	7½	10	15	15	20	30
	575V	[HP]	-	-	-	-	1/2	3/4	1½	3	5	5	7½	10	15	20	20	30	30

MMS-63H

Rated operational current I _e		10	13	17	22	26	32	40	50	63	65
Max. short-circuit current											
240V	[kA]	100	100	100	100	100	100	100	100	100	100
480V	[kA]	65	65	65	65	65	65	65	65	65	65
600V	[kA]	25	25	10	10	10	10	10	10	10	10
Motor load											
1Ø	115V	[HP]	1/2	1/2	1	1½	2	2	3	3	5
	230V	[HP]	1½	2	3	3	3	5	7½	10	10
3Ø	200V	[HP]	2	3	3	5	7½	7½	10	15	20
	230V	[HP]	3	3	5	7½	7½	10	10	15	20
	460V	[HP]	5	7½	10	15	15	20	30	30	40
	575V	[HP]	7½	10	15	20	20	30	30	40	60

MMS-100H

Rated operational current I _e		17	22	26	32	40	50	63	75	90	100
Max. short-circuit current											
240V	[kA]	100	100	100	100	100	100	100	100	100	100
480V	[kA]	65	65	65	65	65	65	50	50	50	50
600V	[kA]	25	25	25	20	20	20	10	10	10	10
Motor load											
1Ø	115V	[HP]	1	1½	2	2	3	3	5	5	7½
	230V	[HP]	3	3	3	5	7½	10	10	15	20
3Ø	200V	[HP]	3	5	7½	7½	10	15	20	20	25
	230V	[HP]	5	7½	7½	10	10	15	20	25	30
	460V	[HP]	10	15	15	20	30	30	40	50	60
	575V	[HP]	15	20	20	30	30	40	60	60	75

Technical Information

Manual motor controller (UL 508)

Manual Motor Controller: Designed manual control of small motors.
 → Must be used in conjunction with a separate circuit breaker or fuse.

* Choose CMC if motor protection is required. Select MMC if only simple control is needed.

MMS-32S

Rated operational current Ie			0.16	0.25	0.4	0.63	1	1.6	2.5	4	6	8	10	13	17	22	26	32	40	
Max. short-circuit current																				
	240V	[kA]	100	100	100	100	100	100	100	100	100	100	50	50	40	30	30	20	20	
	480V	[kA]	50	50	50	50	50	50	50	50	25	25	10	10	10	10	7.5	7.5	7.5	
	600V	[kA]	10	10	10	10	10	10	10	5	5	5	5	5	5	5	5	5	5	
Motor load																				
1Ø	115V	[HP]	-	-	-	-	-	-	-	1/8	1/4	1/3	1/2	1/2	1	1½	2	2	3	
	230V	[HP]	-	-	-	-	-	1/10	1/6	1/3	1/2	1	1½	2	3	3	3	5	7½	
3Ø	200V	[HP]	-	-	-	-	-	-	1/2	3/4	1	2	2	3	3	5	7½	7½	10	
	230V	[HP]	-	-	-	-	-	-	1/2	3/4	1½	2	3	3	5	7½	7½	10	10	
	460V	[HP]	-	-	-	-	-	3/4	1	2	3	5	5	7½	10	15	15	20	30	
	575V	[HP]	-	-	-	-	1/2	3/4	1½	3	5	5	7½	10	15	20	20	30	30	
Max. fuse size			[A]	1	1	1	1	3	6	10	15	20	30	40	50	60	80	100	125	125
Max. breaker size			[A]	15	15	15	15	15	15	15	20	30	40	50	60	80	100	125	125	

MMS-63S

Rated operational current Ie			10	13	17	22	26	32	40	50	63	65
Max. short-circuit current												
	240V	[kA]	100	100	100	100	100	100	100	100	100	100
	480V	[kA]	25	25	25	25	25	25	25	25	25	25
	600V	[kA]	10	10	10	10	10	10	10	10	10	10
모터부하												
1Ø	115V	[HP]	1/2	1/2	1	1½	2	2	3	3	5	5
	230V	[HP]	1½	2	3	3	3	5	7½	10	10	10
3Ø	200V	[HP]	2	3	3	5	7½	7½	10	15	20	20
	230V	[HP]	3	3	5	7½	7½	10	10	15	20	20
	460V	[HP]	5	7½	10	15	15	20	30	30	40	40
	575V	[HP]	7½	10	15	20	20	30	30	40	60	60
Max. fuse size			[A]	40	50	60	80	100	125	150	200	250
Max. breaker size			[A]	40	50	60	80	100	125	150	200	250

MMS-100S

Rated operational current Ie			17	22	26	32	40	50	63	75	90	100
Max. short-circuit current												
	240V	[kA]	100	100	100	100	100	100	100	100	100	100
	480V	[kA]	25	25	25	25	25	25	25	25	25	25
	600V	[kA]	10	10	10	10	10	10	10	10	10	10
Motor load												
1Ø	115V	[HP]	1	1½	2	2	3	3	5	5	7½	10
	230V	[HP]	3	3	3	5	7½	10	10	15	20	20
3Ø	200V	[HP]	3	5	7½	7½	10	15	20	20	25	30
	230V	[HP]	5	7½	7½	10	10	15	20	25	30	30
	460V	[HP]	10	15	15	20	30	30	40	50	60	75
	575V	[HP]	15	20	20	30	30	40	60	60	75	100
Max. fuse size			[A]	60	80	100	125	150	200	250	300	400
Max. breaker size			[A]	60	80	100	125	150	200	250	300	400

MMS-32H

Rated operational current Ie			0.16	0.25	0.4	0.63	1	1.6	2.5	4	6	8	10	13	17	22	26	32	40	
Max. short-circuit current																				
240V	[kA]		100	100	100	100	100	100	100	100	100	100	100	100	100	100	100	100	100	100
480V	[kA]		50	50	50	50	50	50	50	50	50	50	50	50	30	30	30	30	30	30
600V	[kA]		10	10	10	10	10	10	10	10	10	10	10	10	10	10	10	10	10	10
Motor load																				
1Ø	115V	[HP]	-	-	-	-	-	-	-	1/8	1/4	1/3	1/2	1/2	1	1½	2	2	3	
	230V	[HP]	-	-	-	-	-	1/10	1/6	1/3	1/2	1	1½	2	3	3	3	5	7½	
3Ø	200V	[HP]	-	-	-	-	-	-	1/2	3/4	1	2	2	3	3	5	7½	7½	10	
	230V	[HP]	-	-	-	-	-	-	1/2	3/4	1½	2	3	3	5	7½	7½	10	10	
	460V	[HP]	-	-	-	-	-	3/4	1	2	3	5	5	7½	10	15	15	20	30	
	575V	[HP]	-	-	-	-	1/2	3/4	1½	3	5	5	7½	10	15	20	20	30	30	
Max. fuse size			[A]	1	1	1	1	3	6	10	15	20	30	40	50	60	80	100	125	125
Max. breaker size			[A]	15	15	15	15	15	15	15	15	20	30	40	50	60	80	100	125	125

MMS-63H

Rated operational current Ie			10	13	17	22	26	32	40	50	63	65
Max. short-circuit current												
240V	[kA]		100	100	100	100	100	100	100	100	100	100
480V	[kA]		50	50	50	50	50	50	50	50	50	50
600V	[kA]		10	10	10	10	10	10	10	10	10	10
Motor load												
1Ø	115V	[HP]	1/2	1/2	1	1½	2	2	3	3	5	5
	230V	[HP]	1½	2	3	3	3	5	7½	10	10	10
3Ø	200V	[HP]	2	3	3	5	7½	7½	10	15	20	20
	230V	[HP]	3	3	5	7½	7½	10	10	15	20	20
	460V	[HP]	5	7½	10	15	15	20	30	30	40	40
	575V	[HP]	7½	10	15	20	20	30	30	40	60	60
Max. fuse size			[A]	40	50	60	80	100	125	150	200	250
Max. breaker size			[A]	40	50	60	80	100	125	150	200	250

MMS-100H

Rated operational current Ie			17	22	26	32	40	50	63	75	90	100
Max. short-circuit current												
240V	[kA]		100	100	100	100	100	100	100	100	100	100
480V	[kA]		50	50	50	50	50	50	50	50	50	50
600V	[kA]		10	10	10	10	10	10	10	10	10	10
Motor load												
1Ø	115V	[HP]	1	1½	2	2	3	3	5	5	7½	10
	230V	[HP]	3	3	3	5	7½	10	10	15	20	20
3Ø	200V	[HP]	3	5	7½	7½	10	15	20	20	25	30
	230V	[HP]	5	7½	7½	10	10	15	20	25	30	30
	460V	[HP]	10	15	15	20	30	30	40	50	60	75
	575V	[HP]	15	20	20	30	30	40	60	60	75	100
Max. fuse size			[A]	60	80	100	125	150	200	250	300	400
Max. breaker size			[A]	60	80	100	125	150	200	250	300	400

Technical Information

Type '2' coordination according to IEC60947-4-1

Short-circuit Current I_q : 50kA

Voltage : 400/415V, 50/60Hz

Standard Motors AC at 400/415V 1500rpm		Manual motor starter			Contactor	
		Circuit breaker	Thermal overload release setting range	Magnetic release response current		
[kW]	[A]	Type	[A]	[A]	Type	[A]
-	-	MMS-32S 0.16A	0.1~0.16	2.1	GMC-6M / MC-9a / MC-9b	6 / 9
0.06	0.2	MMS-32S 0.25A	0.16~0.25	3.3	GMC-6M / MC-9a / MC-9b	6 / 9
0.09	0.3	MMS-32S 0.4A	0.25~0.4	5.2	GMC-6M / MC-9a / MC-9b	6 / 9
0.12	0.4	MMS-32S 0.63A	0.4~0.63	8.2	GMC-6M / MC-9a / MC-9b	6 / 9
0.18	0.6	MMS-32S 1A	0.63~1	13	GMC-6M / MC-9a / MC-9b	6 / 9
0.25	0.8	MMS-32S 1A	0.63~1	13	GMC-6M / MC-9a / MC-9b	6 / 9
0.37	1.1	MMS-32S 1.6A	1~1.6	20.8	GMC-6M / MC-9a / MC-9b	6 / 9
0.55	1.5	MMS-32S 1.6A	1~1.6	20.8	GMC-6M / MC-9a / MC-9b	6 / 9
0.75	1.9	MM-32S 2.5A	1.6~2.5	32.5	MC-12a / MC-12b	12
1.1	2.7	MMS-32S 4A	2.5~4	52	MC-18a / MC-18b	18
1.5	3.6	MMS-32S 4A	2.5~4	52	MC-18a / MC-18b	18
2.2	5.2	MMS-32S 6A	4~6	78	MC-18a / MC-18b	18
3	6.8	MMS-32S 8A	5~8	104	MC-18a / MC-18b	18
4	9	MMS-32S 10A	6~10	130	MC-18a / MC-18b	18
5.5	11.5	MMS-32H 13A	9~13	169	MC-22b	22
7.5	15.5	MMS-32H 17A	11~17	221	MC-22b	22
10	20	MMS-32H 22A	14~22	286	MC-32a	32
11	22	MMS-32H 26A	18~26	338	MC-32a	32
15	29	MMS-32H 32A	22~32	416	MC-32a	32
18.5	35	MMS-63H 40A	28~40	520	MC-40a	40
22	41	MMS-63H 50A	34~50	650	MC-50a	50
30	55	MMS-63H 63A	45~63	819	MC-65a	65
37	67	MMS-100S 75A	55~75	975	MC-75a	75
-	-	MMS-100S 90A	70~90	1170	MC-85a	85
45	80	MMS-100S 100A	80~100	1300	MC-85a	85

Definition of type '2' coordination according to IEC 60947-4-1 :

- The contactor or the starter must not endanger individuals or systems in the event of a short-circuit.
- The contactor or the starter must be suitable for general applications.
- No damage to the overload relay or other parts may occur with the exception of welding the contactor or starter contacts provided that the components can be easily separated without significant deformation (such as with a screwdriver).

LS MMS ready for IE3-rated motors

Type	Rated current(A)	Short-circuit current(A)	Current range(A)			Short-circuit current ratio		
			Min	Mid	Max	Min	Mid	Max
32	0.16A	2.1	0.1	0.13	0.16	20.8	16.0	13.0
	0.25A	3.3	0.16	0.2	0.25	20.3	16.3	13.0
	0.4A	5.2	0.25	0.33	0.4	20.8	15.8	13.0
	0.63A	8.2	0.4	0.52	0.63	20.5	15.8	13.0
	1A	13.0	0.63	0.81	1	20.6	16.0	13.0
	1.6A	20.8	1	1.3	1.6	20.8	16.0	13.0
	2.5A	32.5	1.6	2.1	2.5	20.3	15.5	13.0
	4A	52	2.5	3.3	4	20.8	15.8	13.0
	6A	78	4	5	6	19.5	15.6	13.0
	8A	104	5	6.5	8	20.8	16.0	13.0
	10A	130	6	8	10	21.7	16.3	13.0
	13A	169	9	11	13	18.8	15.4	13.0
	17A	221	11	14	17	20.1	15.8	13.0
	22A	286	14	18	22	20.4	15.9	13.0
	26A	338	18	22	26	18.8	15.4	13.0
	32A	416	22	27	32	18.9	15.4	13.0
40A	520	28	34	40	18.6	15.3	13.0	
63	10A	130	6	8	10	21.7	16.3	13.0
	13A	169	9	11	13	18.8	15.4	13.0
	17A	221	11	14	17	20.1	15.8	13.0
	22A	286	14	17	22	20.4	16.8	13.0
	26A	338	18	22	26	18.8	15.4	13.0
	32A	416	22	27	32	18.9	15.4	13.0
	40A	520	28	34	40	18.6	15.3	13.0
	50A	650	34	42	50	19.1	15.5	13.0
	63A	819	45	54	63	18.2	15.2	13.0
	65A	845	47	56	65	18.0	15.1	13.0
100	17A	221	11	14	17	20.1	15.8	13.0
	22A	286	14	18	22	20.4	15.9	13.0
	26A	338	18	22	26	18.8	15.4	13.0
	32A	416	22	27	32	18.9	15.4	13.0
	40A	520	28	34	40	18.6	15.3	13.0
	50A	650	34	42	50	19.1	15.5	13.0
	63A	819	45	54	63	18.2	15.2	13.0
	75A	975	55	65	75	17.7	15.0	13.0
	90A	1170	70	80	90	16.7	14.6	13.0
100A	1300	80	90	100	16.3	14.4	13.0	

IE3 De-rating table

What is the IE3?

Motors rated from IE1 through IE4 vary in energy efficiency with IE3 being more efficient compared to IE1 and IE2-rated motors.

Why IE3?

As part of the EU Environmental policy "20/30-20-20" strategy, the EU is committed to achieving the following by 2020:

- Reduce Greenhouse Gas Emissions by up to 30%
- Increase the Share of Renewable Energy to 20% and
- Boost Energy Efficiency by 20%

IEC 60034-30 standard specifies IE classes for motors in accordance with the above requirements. Therefore, consumers must comply with the standard when using MMS products.

How to select MMS?

To meet the IE3 motor starting current and inrush current, adhering to the de-rating table is recommended. (13 times the rated current)

Example:

When selecting product A or B:

A: MMS setting scale 11 ~ 17A

B: MMS setting scale 14 ~ 22A

Rated motor current : 16A

The short-circuit current of MMS A is 221A (17*13), and MMS B is 286A (22*13).

When applying the motor's rated current (16A) to MMS A, the multiplier of the short-circuit current is 13.8 times. When applying the motor's rated current (16A) to MMS B, the multiplier of the short-circuit current is 17.9 times. If IE3 motor or above is used here, malfunction can occur due to higher starting current compared to IE1 or 2 motor. Therefore, MMS B is recommended since it has the higher multiplier of the short-circuit current.



Characteristic curve

[mm]

Tripping curve

MMS-32D

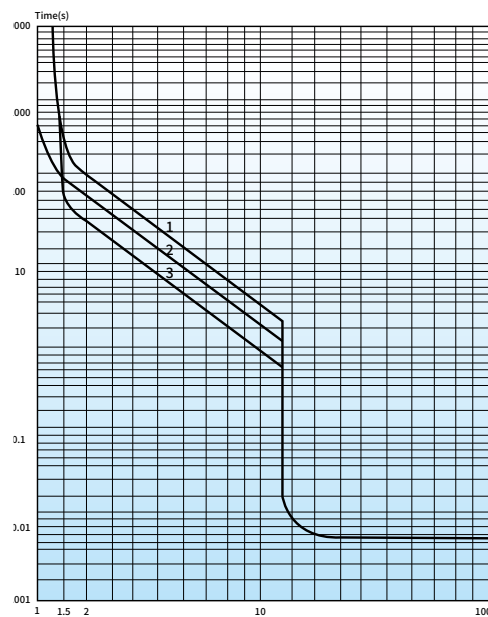

MMS-32AF

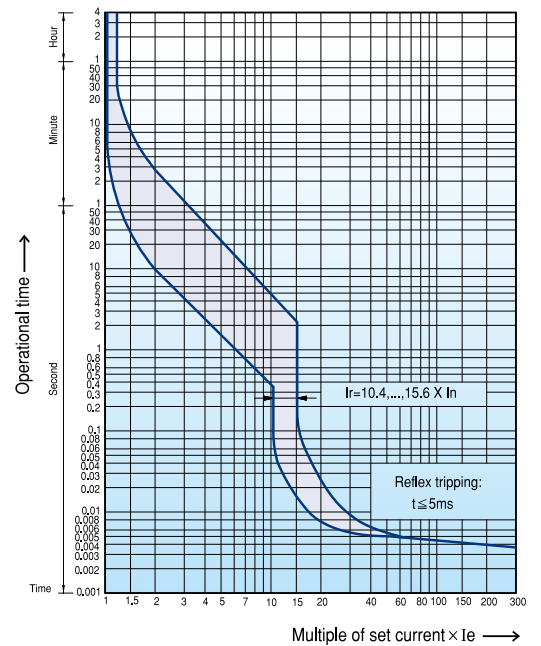

MMS-63, 100AF

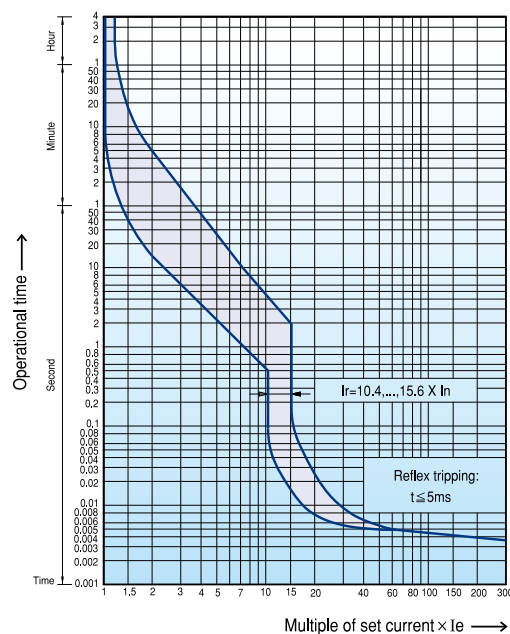

Thermal release trip current

The adjustable inverse bimetal trip reliability feature protects motors against overloads. The curve shows the mean operating current at an ambient temperature of 20°C starting from cold. Careful testing and setting ensures effective motor protection even in the case of single phase.

Magnetic release trip current

The instantaneous magnetic trip has a fixed operating current setting. This corresponds to 13 times the maximum value of the setting range. At a lower setting it is correspondingly higher.

Current setting Ie

The overload trip corresponds to a thermal overload relay in a motor starter conforming to IEC 947-4-1. If a different value is prescribed (e.g. reduced Ie for cooling medium having a temperature higher than 40°C or a place of installation higher than 2000m above sea level), the setting current is equal to the reduced rated current Ie of the motor.

Thermal limit on short-circuit

Thermal limit in kA²s in the magnetic operating zone ($U_e=415V$)

MMS-32S/H/Hi

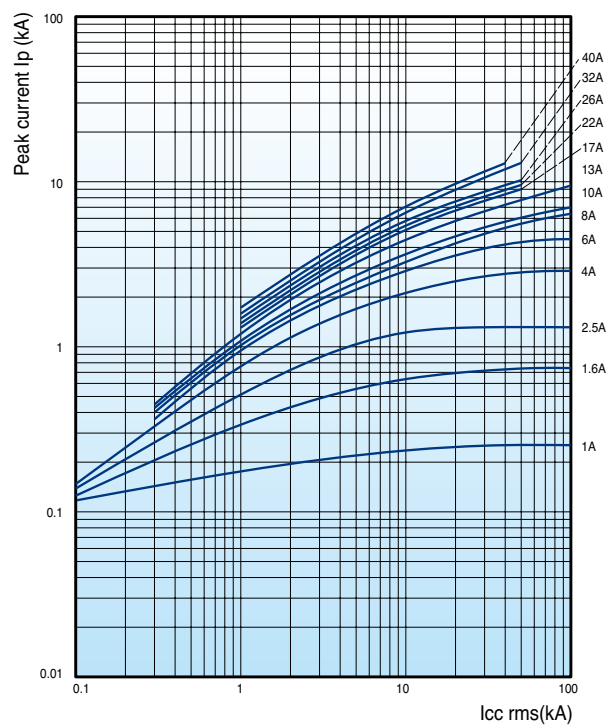
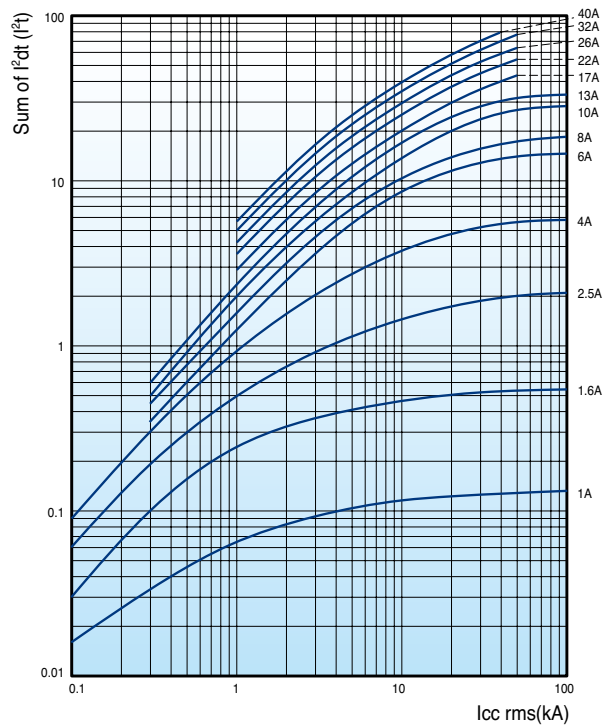

MMS-63S/H/HI

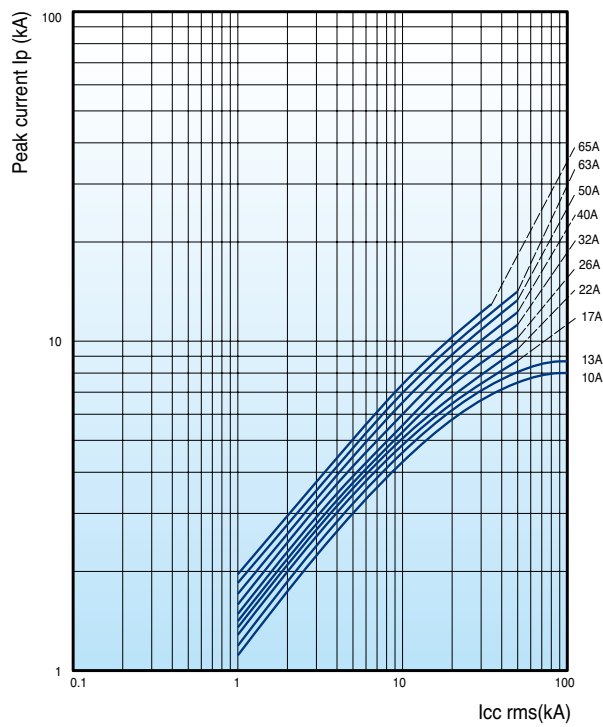
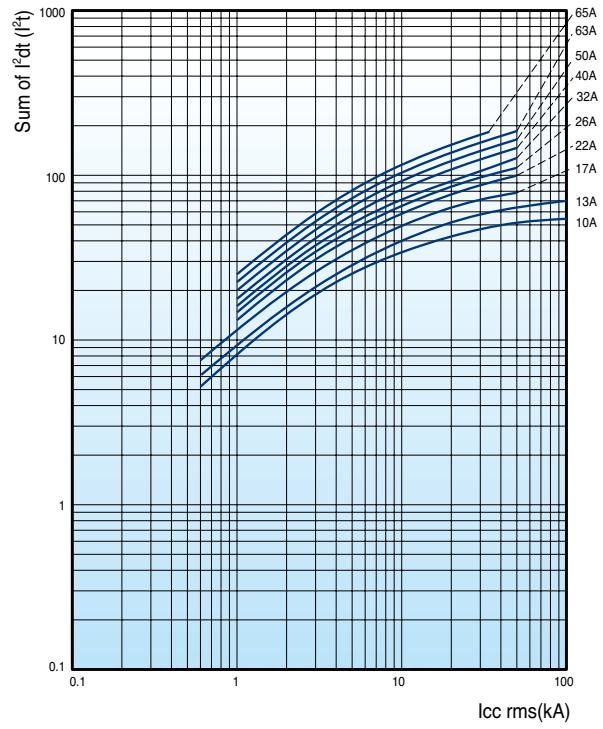

Thermal limit in kA2s in the magnetic operating zone ($U_e=415V$)

MMS-100S/H/Hi

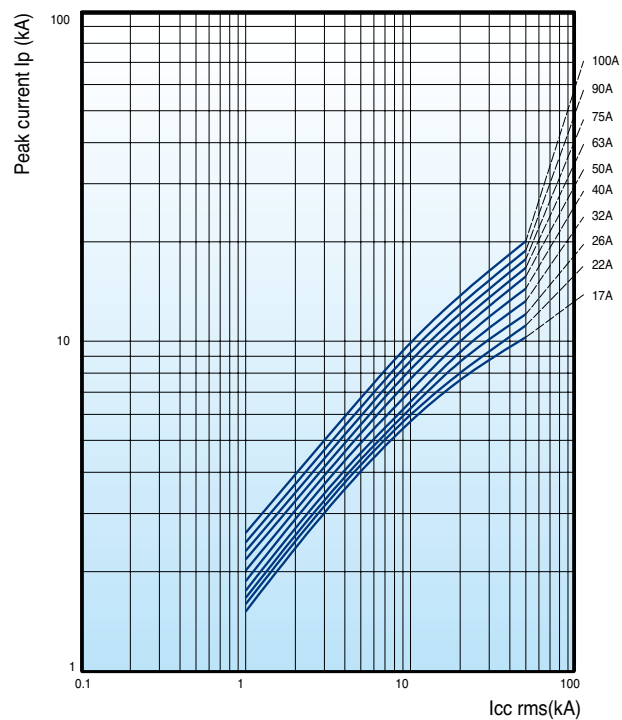
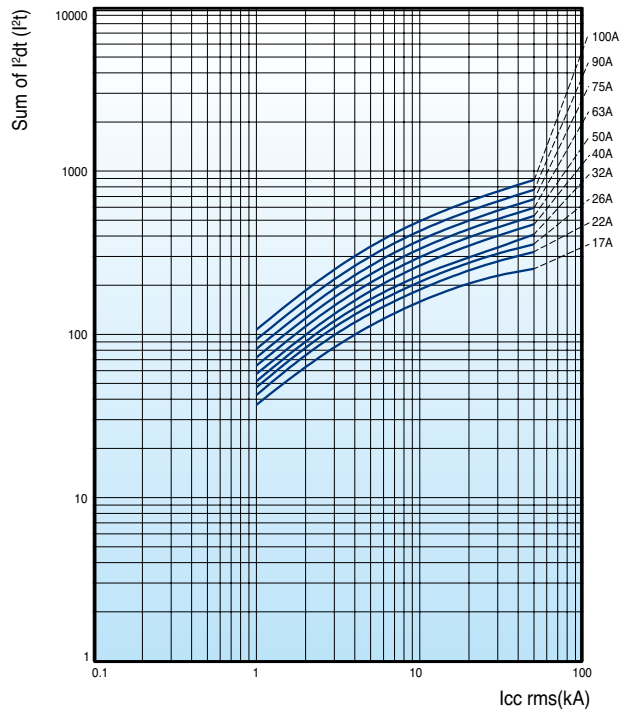

MMS

[mm]

MMS-32D

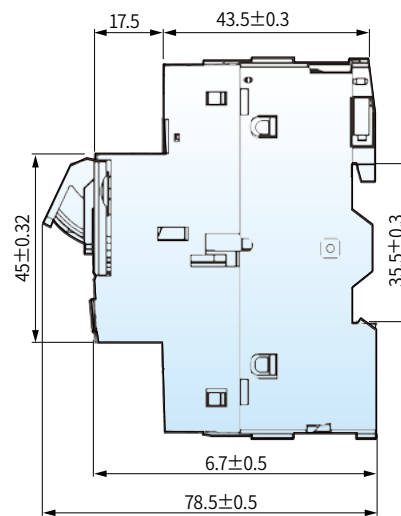
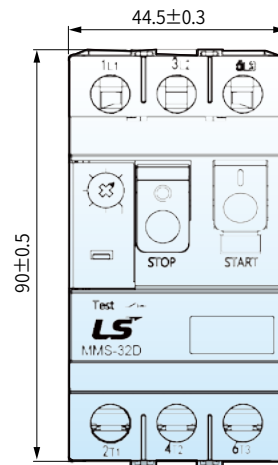

Dimensions

MMS

[mm]

MMS-32S

- 1) Side auxiliary switch
- 2) Side magnetic trip alarm switch
- 3) Side shunt release or side undervoltage release
- 4) Front auxiliary switch
- 5) Push-in lugs for screw mounting
- 6) 35mm standard mounting rail acc. to EN 50 022

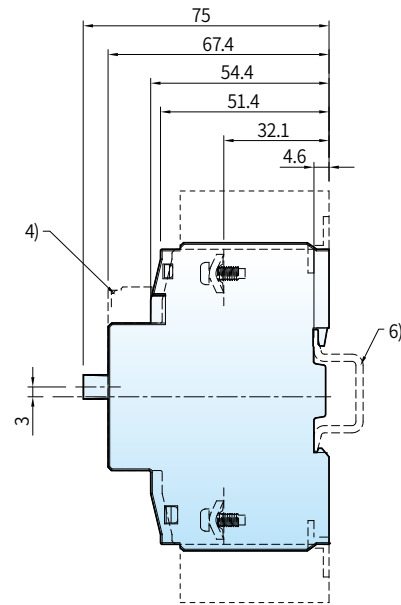
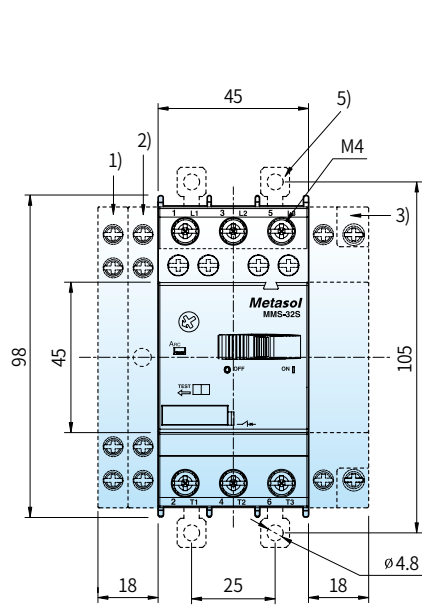

0.32kg

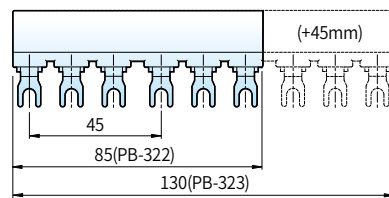
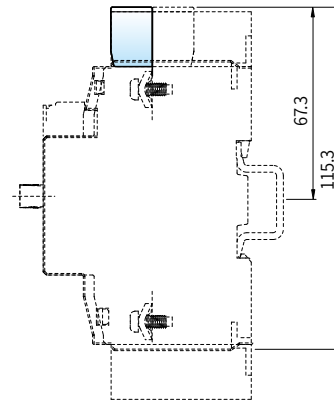
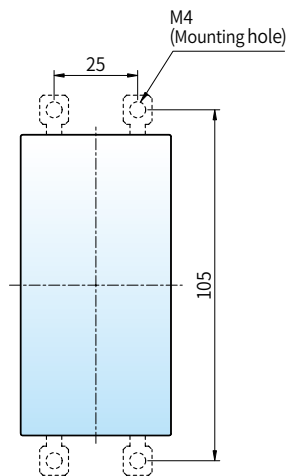

MMS-32S+PB-32
PB-322 (2 Terminals), PB-323 (3 Terminals)
PB-324 (4 Terminals), PB-325 (5 Terminals)

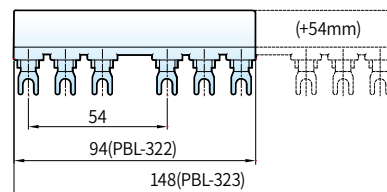

MMS-32S+PBL-32
PBL-322(2 Terminals), PBL-323 (3 Terminals)

[mm]

MMS-32H, 32HI

- 1) Side auxiliary switch
- 2) Side magnetic trip alarm switch
- 3) Side shunt release or side undervoltage release
- 4) Front auxiliary switch
- 5) Handle lock in Off position (Ø5mm)
- 6) Push-in lugs for screw mounting
- 7) 35mm standard mounting rail acc. to EN 50 022

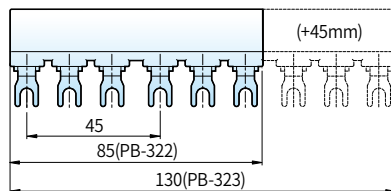
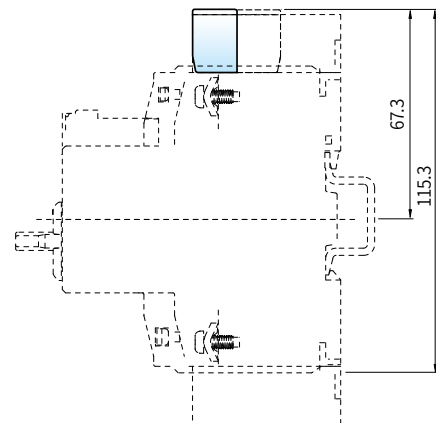
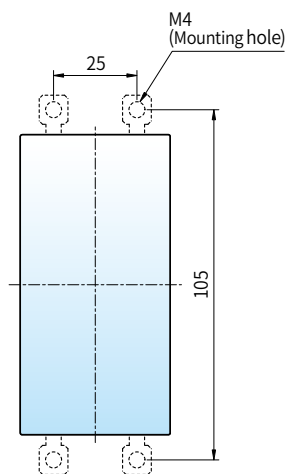
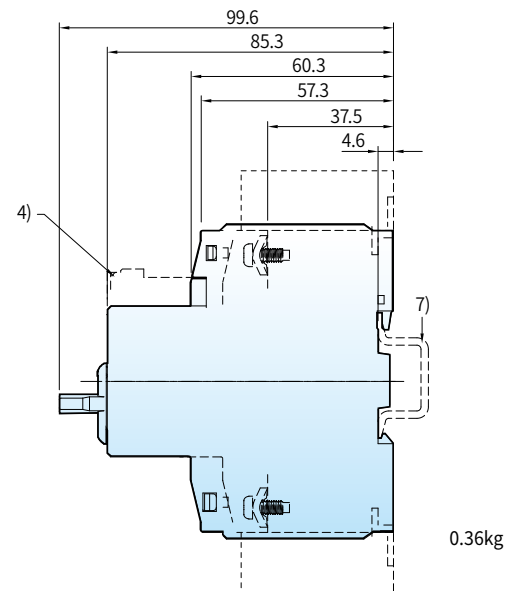
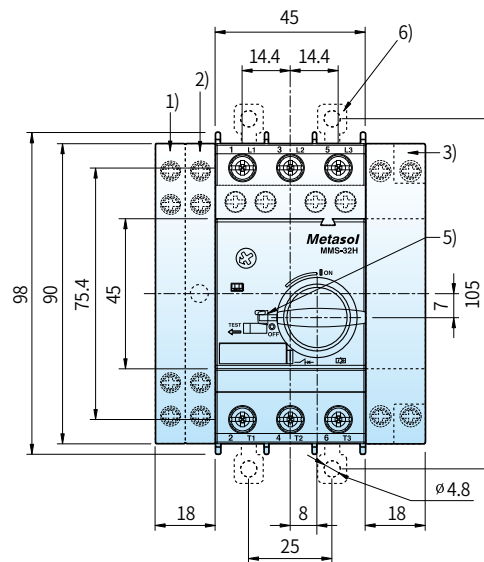

MMS-32H/32HI+PB-32
PB-322 (2 Terminals), PB-323 (3 Terminals)
PB-324 (4 Terminals), PB-325 (5 Terminals)

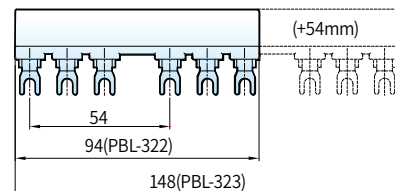

MMS-32H/32HI+PBL-32
PBL-322 (2 Terminals), PBL-323 (3 Terminals)

Dimensions

MMS

[mm]

MMS-63S, 63H, 63HI

- 1) Side auxiliary switch or side magnetic trip alarm switch
- 2) Side shunt release or side undervoltage release
- 3) Front auxiliary switch
- 4) Handle lock in Off position (Ø5mm)
- 5) 35mm standard mounting rail acc. to EN 50 022

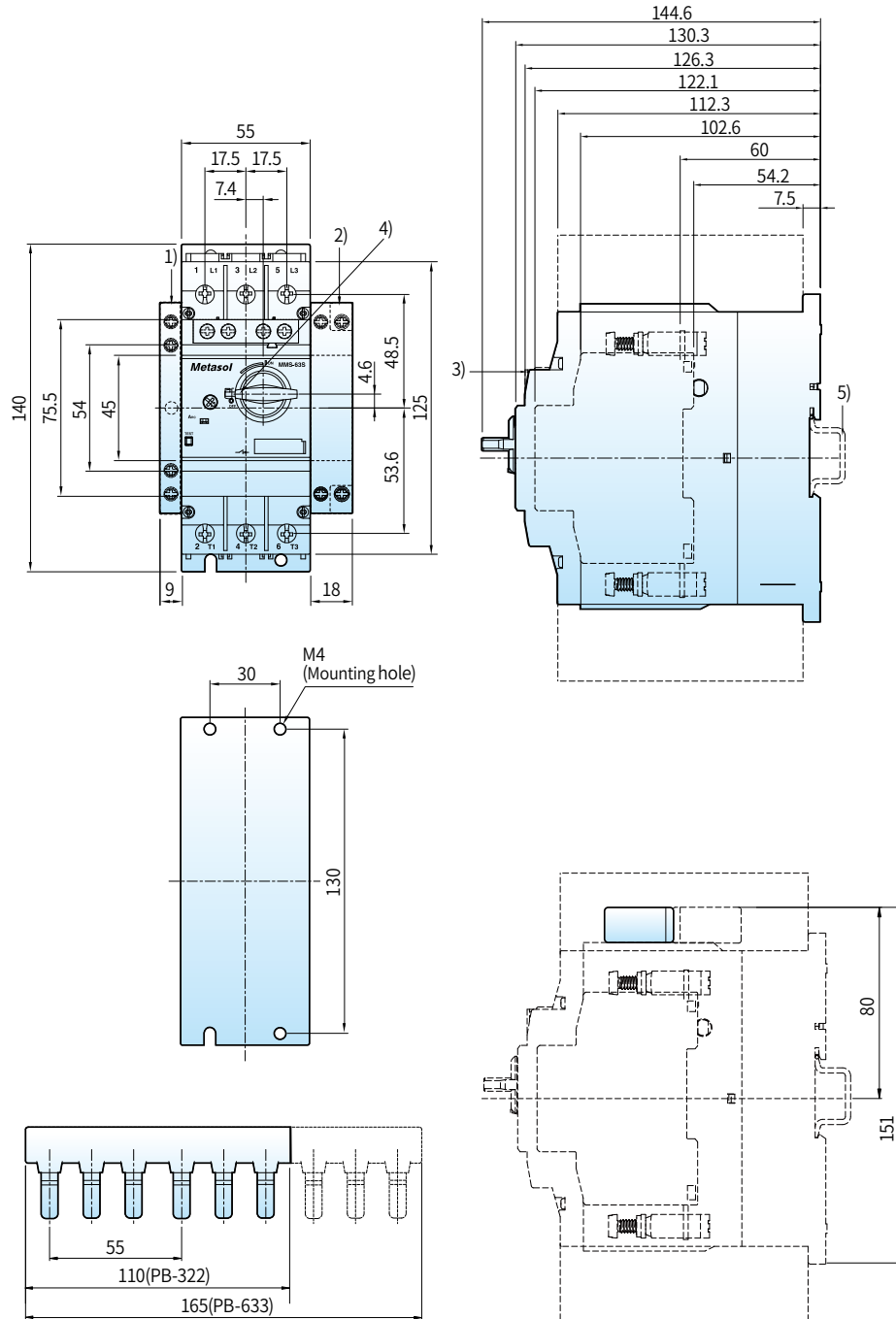

1kg

MMS-63S/H/HI+PB-63
PB-632 (2 Terminals), PB-633 (3 Terminals)

[mm]

MMS-100S, 100H, 100HI

- 1) Side auxiliary switch
- 2) Side magnetic trip alarm switch
- 3) Side shunt release or side undervoltage release
- 4) Front auxiliary switch
- 5) Handle lock in Off position (Ø5mm)
- 6) 35mm standard mounting rail acc. to EN 50 022
- 7) 75mm standard mounting rail acc. to EN 50 023
- 8) 4mm hexagon socket screw

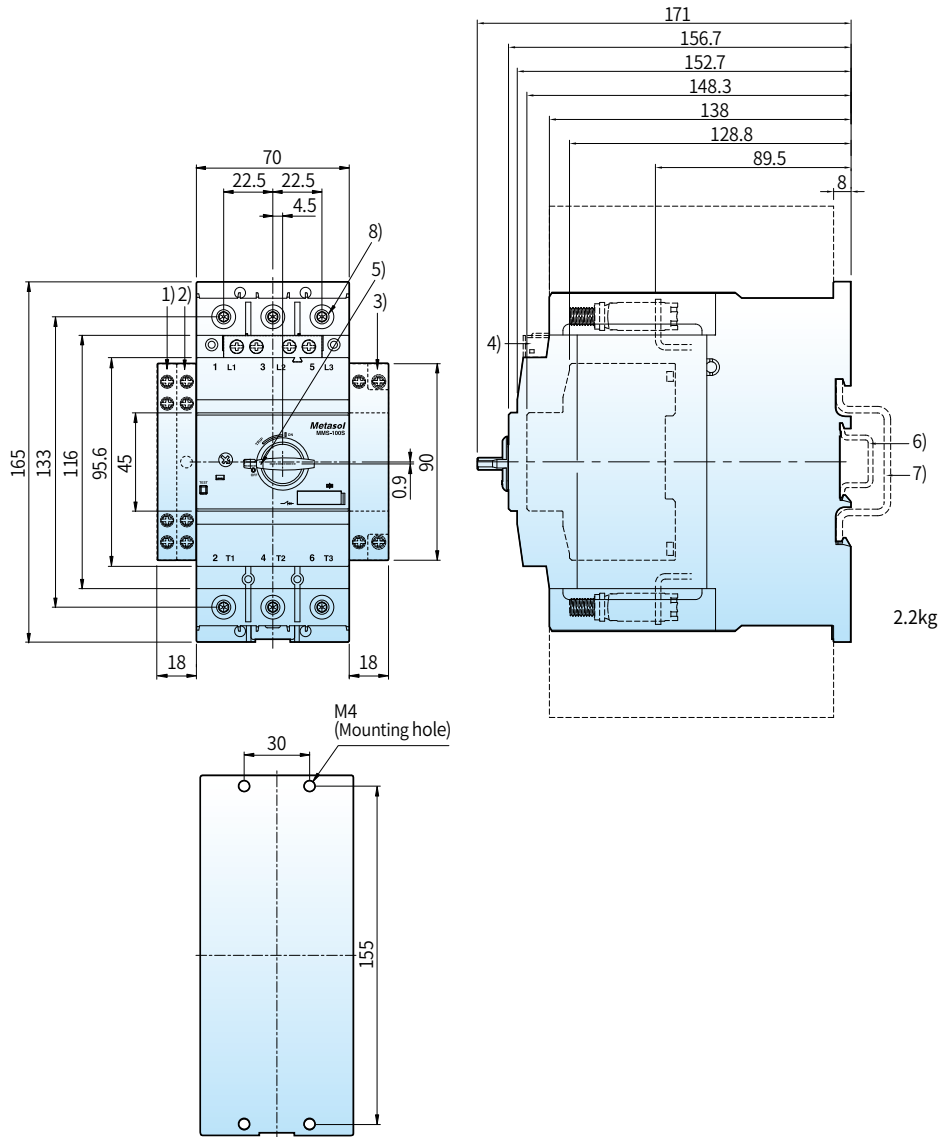

Dimensions

MMS + Mini-MS

[mm]

MMS-32S+
GMC(D)-6M~16M

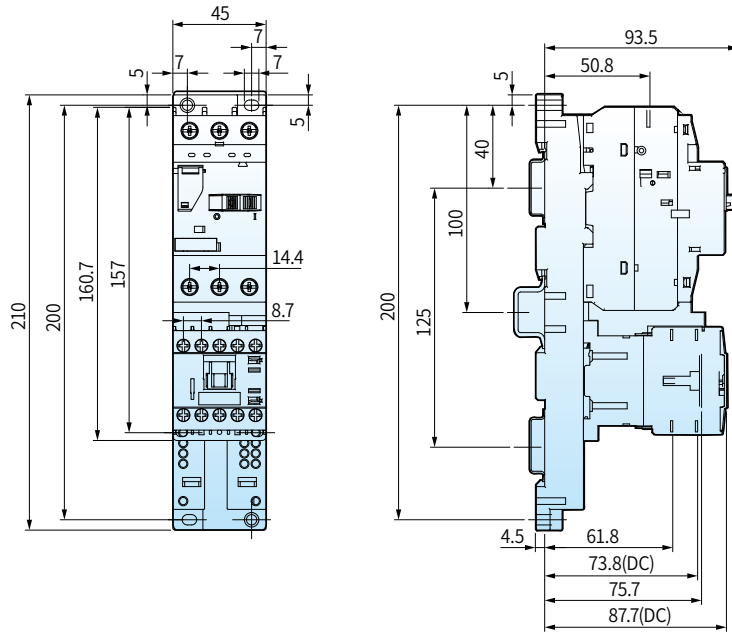

MMS-32H+
GMC(D)-6M~16M

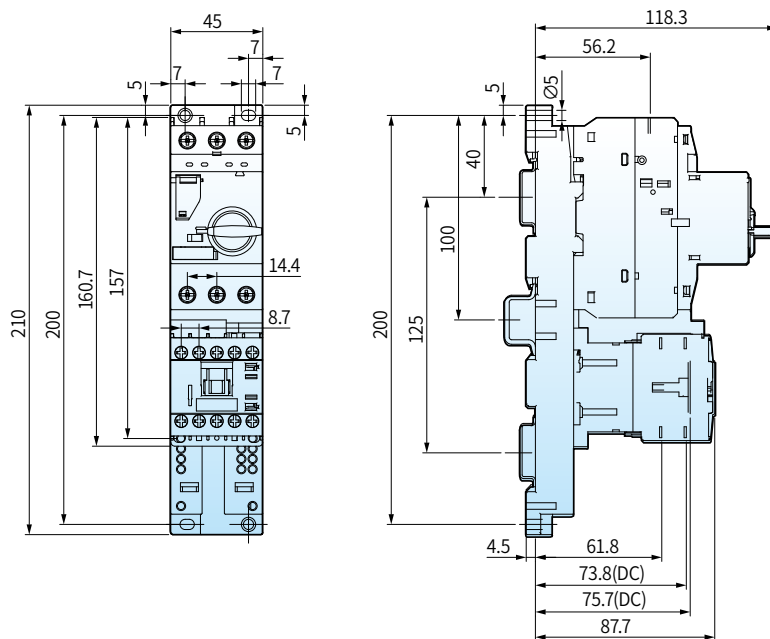

MMS + Metasol MC

[mm]

MMS-32S+
MC-6a~18a

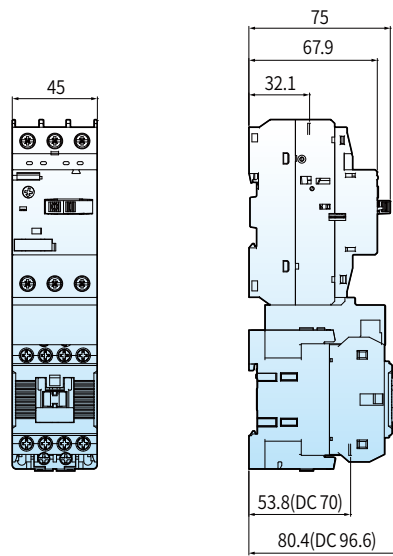

MMS-32S+
MC-9b~22b

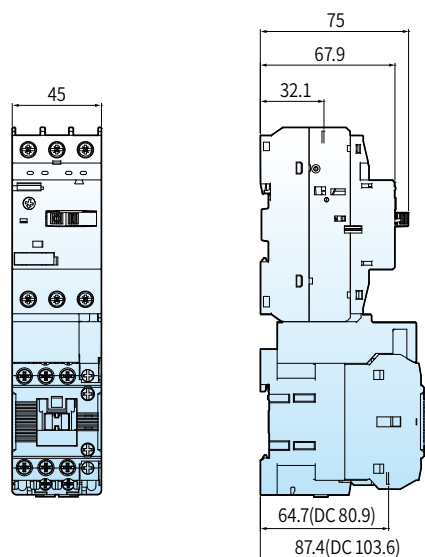

Dimensions

MMS + Metasol MC

[mm]

MMS-32S+MC-32a

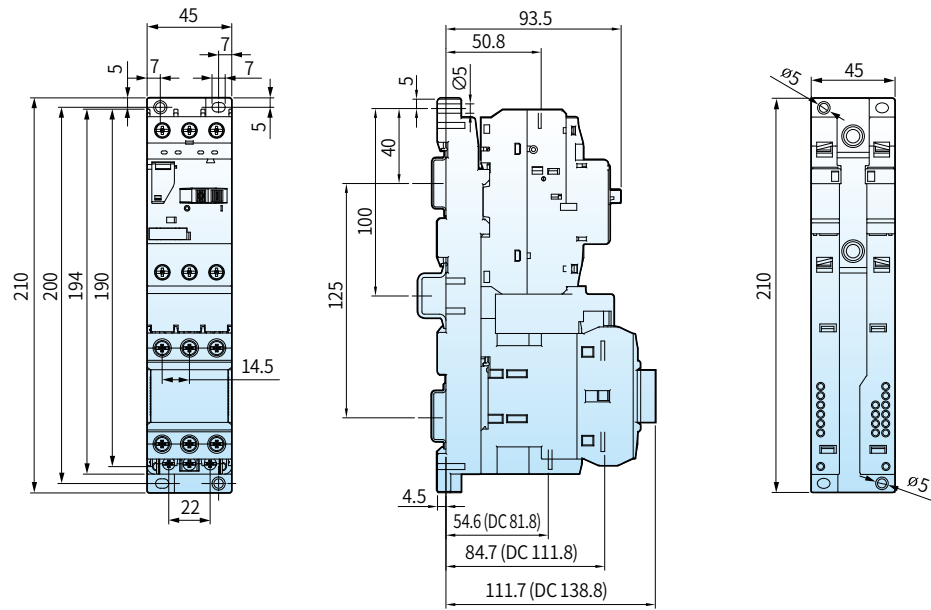

MMS-32H, HI+MC-6a~18a

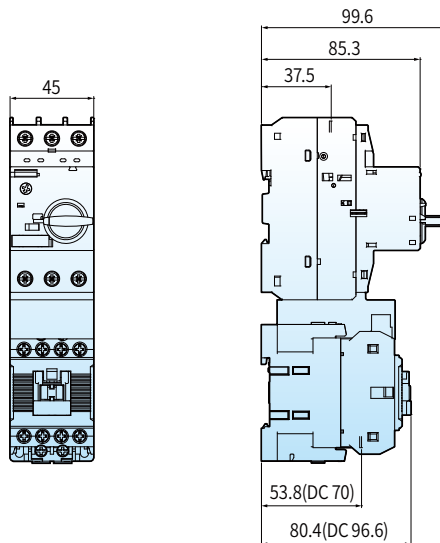

[mm]

MMS-32H,
HI+MC-9b~22b

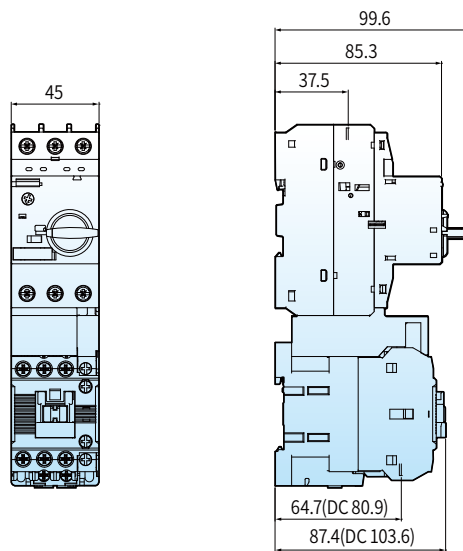

MMS-32H+MC-32a

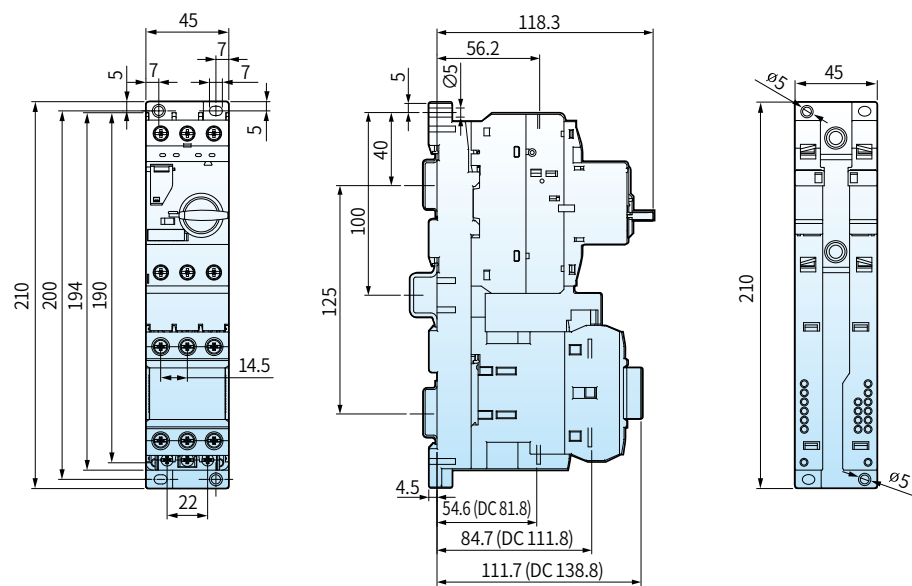

Dimensions

MMS + Metasol MC

[mm]

MMS-63H+MC-63a

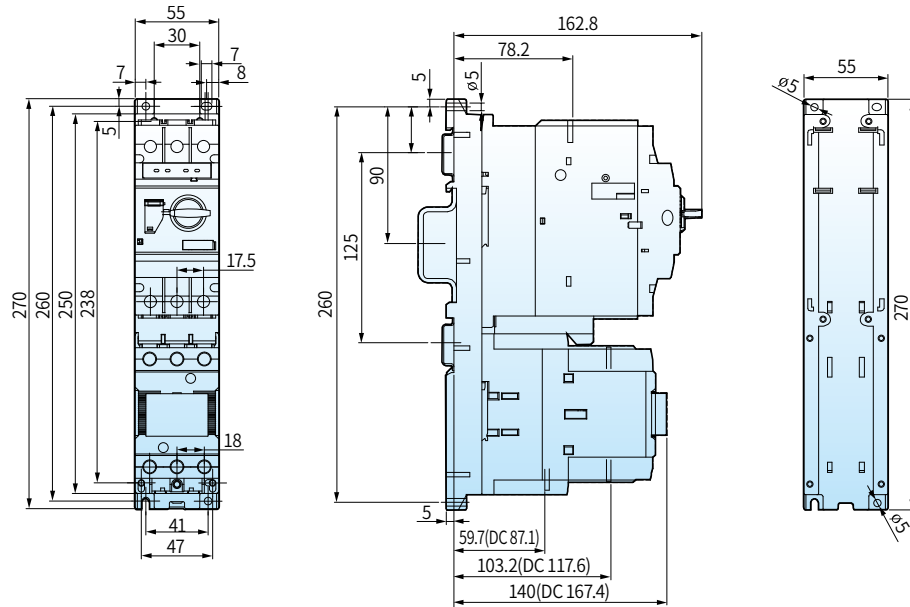

MMS-100H+MC-100a

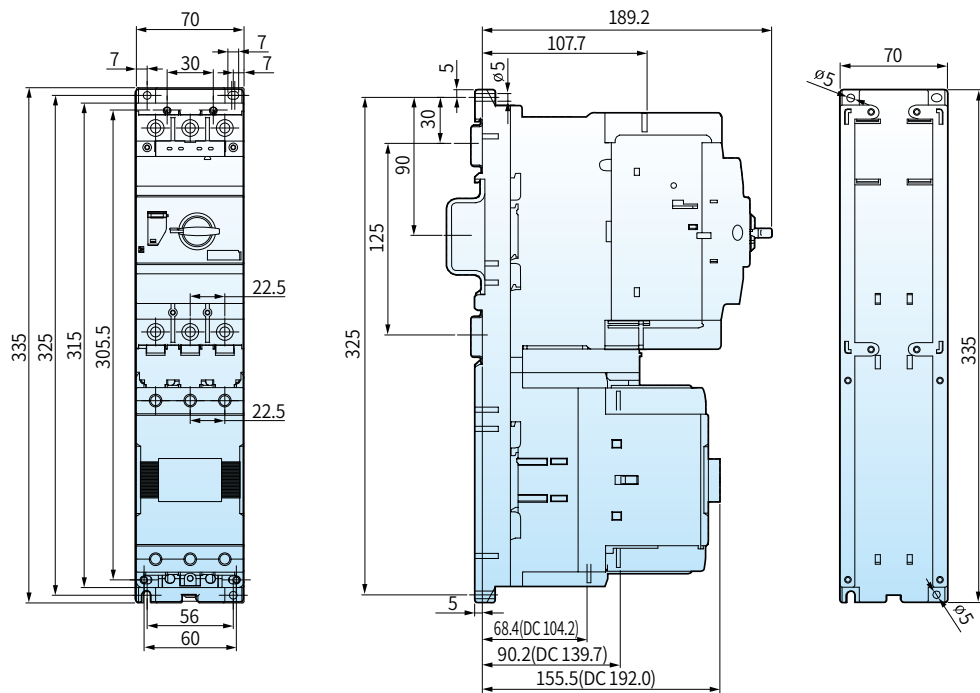

External accessories

[mm]

E-handle

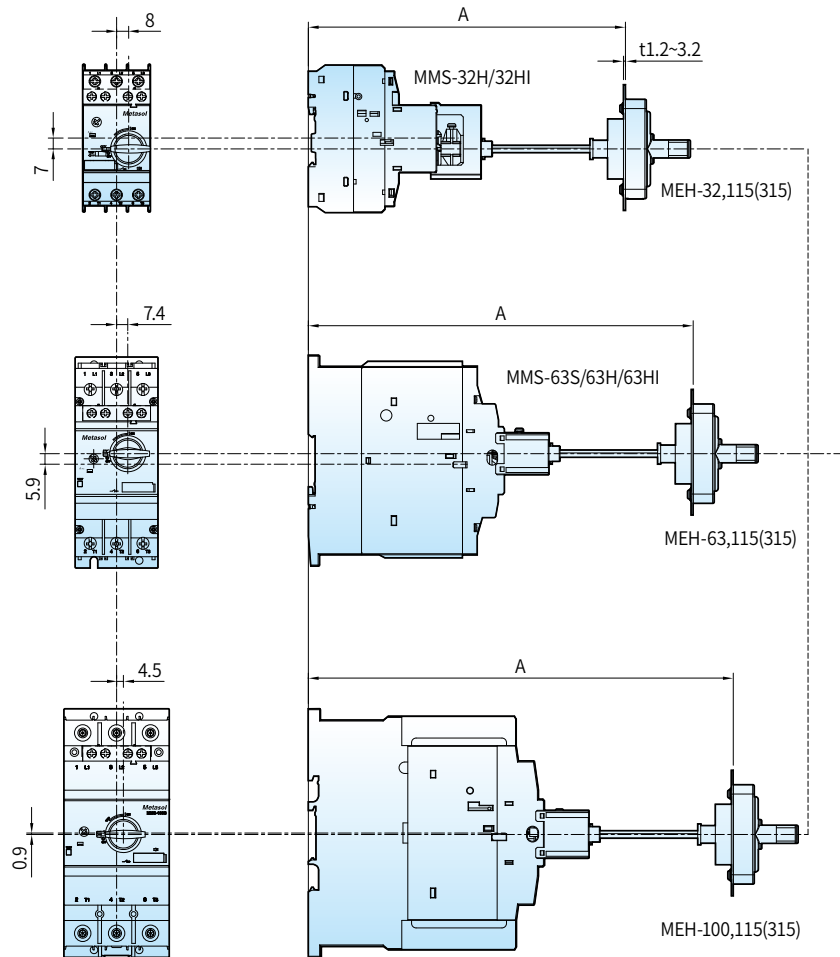

E-handle type	A(mm)	MMS type
MEH-32, 115	min : 148.6	MMS-32H/32HI
	max:210.6 (Shaft 115mm)	
MEH-32, 315	min : 148.6	
	max:410.6 (Shaft 315mm)	
MEH-63, 115	min : 193.6	MMS-63S/63H/63HI
	max:255.6 (Shaft 115mm)	
MEH-63, 315	min : 193.6	
	max:455.6 (Shaft 315mm)	
MEH-100, 115	min : 220	MMS-100S/100H/100HI
	max:282 (Shaft 115mm)	
MEH-100, 315	min : 220	
	max:482 (Shaft 315mm)	

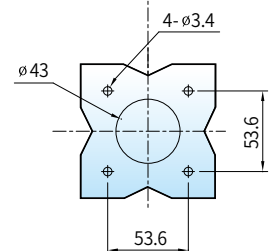

Dimensions

External accessories

[mm]

Enclosure

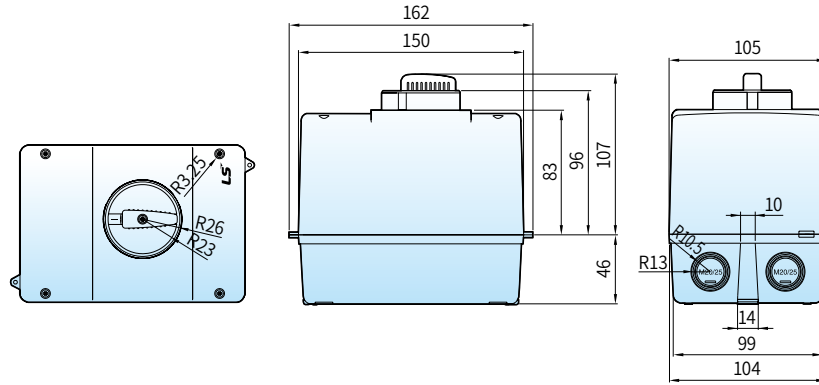

Phase bus

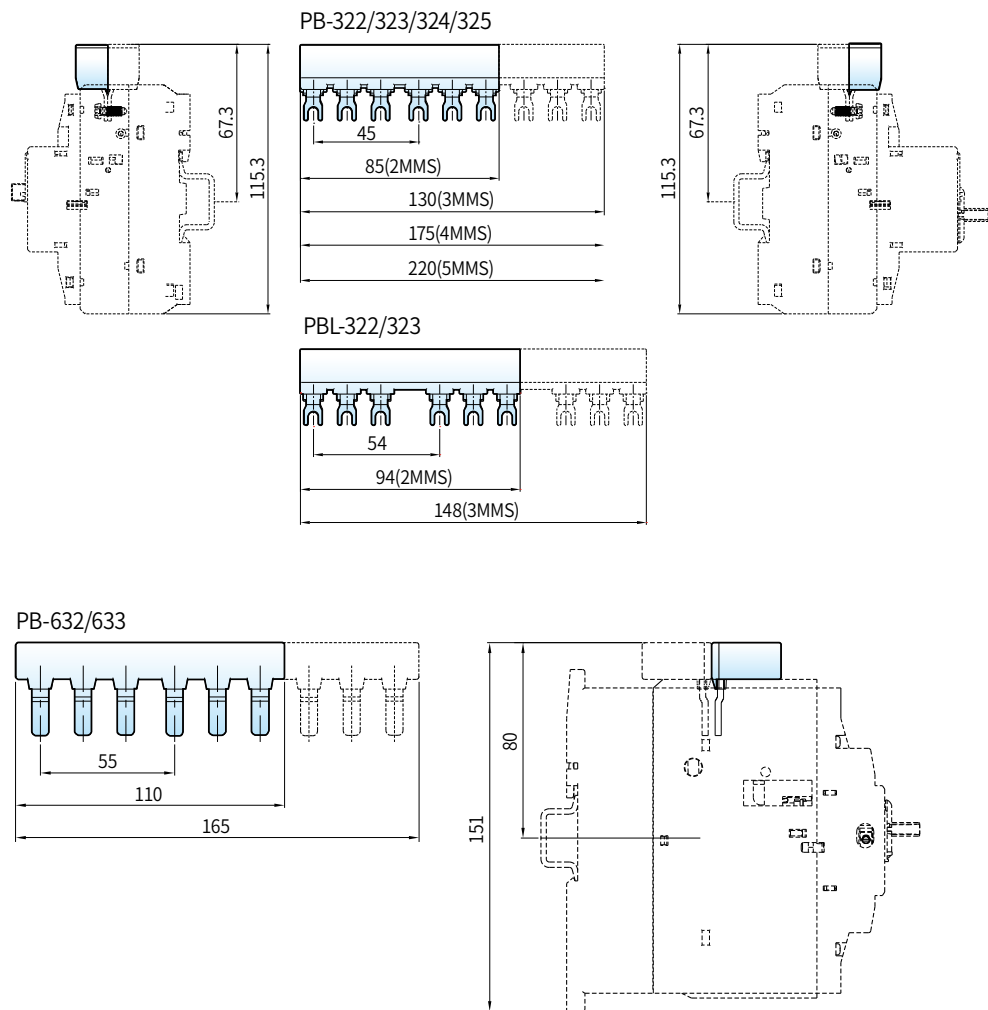

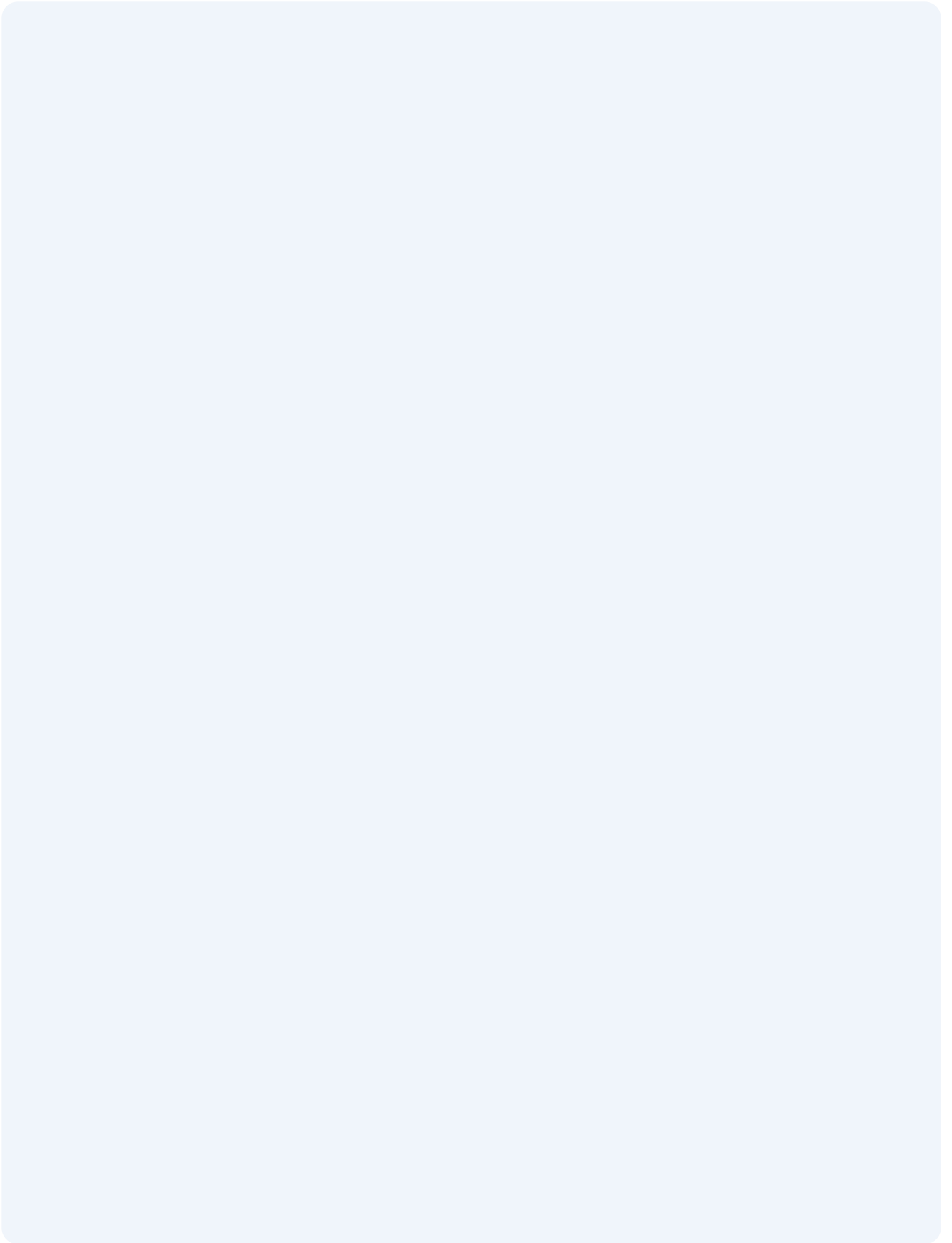

DIGITAL SUPPORT HUB

SCAN THE QR CODE FOR INSTANT PRODUCT INFORMATION AND EXPERT SUPPORT

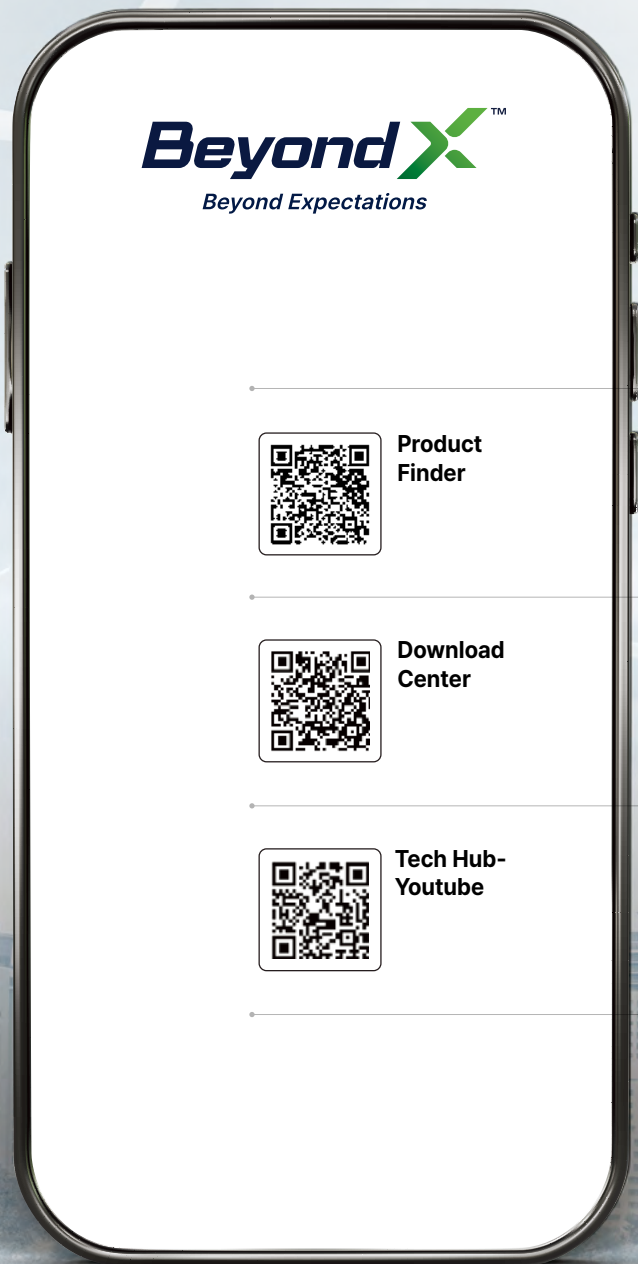



Product Finder

Search Smarter.
Find Faster

Quickly discover the best-fit product for your needs



Download Center

Download with
Ease and Speed

Instantly access datasheets, manuals, and CAD files



Tech Hub-Youtube

Expert Guidance,
Now on YouTube

Watch trusted tutorials and product guides from real experts





Headquarter

127 LS-ro (Hogye-dong) Dongan-gu, Anyang-si, Gyeonggi-Do, 14119, Korea

Seoul Office

LS Yongsan Tower, 92, Hangang-daero, Yongsan-gu, Seoul, 04386, Korea
TEL: 82-2-2034-4916, 4684, 4429

China

LS ELECTRIC (Dalian) Co., Ltd.
+86-411-8730-5872
china.dalian@lselectric.com.cn

LS ELECTRIC (Wuxi) Co., Ltd.
+86-510-6851-6666
china.wuxi@lselectric.com.cn

LS ELECTRIC (Lishui) Co., Ltd.
+86-578-6866-780
china.lishui@lselectric.com.cn

Shanghai Office

+86-21-5237-9977
china@lselectric.com.cn

Beijing Office

+86-10-5095-1631
china@lselectric.com.cn

Guangzhou Office

+86-20-3818-2883
china@lselectric.com.cn

Qingdao Office

+86-532-8501-2065
china@lselectric.com.cn

Chengdu Office

+86-28-8670-3201
china@lselectric.com.cn

Nanjing Office

+86-25-84 67-0005
china@lselectric.com.cn

India

India Office
+91-80-6142-9108
Info_india@ls-electric.com

Indonesia

PT. LS ELECTRIC INDONESIA
+62-21-2933-7614
indonesia@ls-electric.com

PT SYMPHOS ELECTRIC

+62-81-1900-1474
marketing@symphos-weltraf.com

Italy

Italy office
+39-030-8081-833
italia@ls-electric.com

Japan

LS ELECTRIC Japan Co., Ltd.
+81-3-6268-8241
japan@ls-electric.com

Tokyo Office

+81-3-6268-8241
tokyo@ls-electric.com

Netherlands

LS ELECTRIC Europe B.V.
+31-20-654-1424
europartner@ls-electric.com

Russia

Moscow Office
+7-499-682-6130
info@lselectric-ru.com

Singapore

Singapore Office
+65-6958-8162
singapore@ls-electric.com

Spain

LS ELECTRIC IBERIA S.L.U.
+34-910-28-02-74
iberia@ls-electric.com

Thailand

Bangkok Office
+66-2-128-0295
thailand@ls-electric.com

Türkiye

LS ELECTRIC Türkiye Co., Ltd.
+90-212-806-1252
turkiye@ls-electric.com

U.A.E

LS ELECTRIC Middle East FZE (Dubai)
+971-4-886-5360
middleeast@ls-electric.com

USA

LS ELECTRIC America Inc.
+1-800-891-2941
sales.us@lselectricamerica.com

LS ENERGY SOLUTIONS LLC

+1-980-221-0654
info@ls-es.com

MCM Engineering II

+1-435-865-0125
sales.us@lselectricamerica.com

America Western Office

+1-949-333-3140
america@ls-electric.com

America Bastrop Campus

+1-800-891-2941 EXT 2
power_support.us@lselectricamerica.com

Vietnam

LS ELECTRIC Vietnam Co., Ltd.
+84-222-2221-110
vietnam@ls-electric.com

Hanoi Office

+84-24-6275-8054
vietnam@ls-electric.com

Ho Chi Minh Office

+84-3823-7890
vietnam@ls-electric.com

Specifications in this catalog are subject to change without notice due to continuous product development and improvement

© 2021. 03 LS ELECTRIC Co.,Ltd. All rights reserved. / English (05) 2025. 12 Human Power

www.ls-electric.com